



Hand Tools Catalogue 2023





WE ARE SATA®

SATA® has been the fastest growing premium-quality mechanics' hand tool company globally over the last 20 years. Our selection of products is designed and manufactured to serve professional mechanics as well as manufacturing and assembly technicians in a variety of industries including automotive, manufacturing, construction and aerospace.

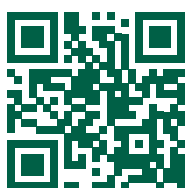

Discover SATA®



We challenge the status quo by delivering world-class quality, industry-leading innovation, and a highly gratifying experience with our brand.

SATA® tools meet or exceed ANSI and DIN standards. SATA® tool manufacturing facilities are ISO 9001 certified and Apex Tool Group provides Lifetime Warranty on SATA® tools.

SATA® is part of the umbrella company Apex Tool Group, LLC. The Apex Tool Group works collaboratively with distributors, retailers and large customers across the globe to make sure end users have the tools they need to solve real-world problems.

SATA® tools are your ideal choice!

THE SATA® PROMISE



TRUSTED BRAND MADE TO CHALLENGE

SATA® is the fastest growing hand tool company
– trusted by professionals globally.



WORLD CLASS QUALITY AND PERFORMANCE

Professionals count on SATA®'s high quality,
innovation and world-class service.



A TOOL FOR EVERY JOB

From simple to unique projects, SATA® has
the tools to get every job done.



LIFETIME WARRANTY

All SATA® Products will be repaired/replaced
free of charge at SATA®'s discretion.



SATA® is part of the umbrella company Apex Tool Group, LLC. With 7,500 employees in over 30 countries and an annual turnover of more than USD 1,3 billion, the Apex Tool Group, headquartered in Sparks, Maryland, is a leading global manufacturer and supplier of high-performance hand and power tools, tool storage, drill chucks, chain and electrical soldering products for industrial, commercial and demanding do-it-yourself applications.

ATG designs, manufactures, markets, and sells proprietary brands, including GEARWRENCH®, Crescent®, SATA®, Cleco®, Weller®, and APEX® and also designs and manufactures a number of private label tool brands for retailers. ATG sells its products through direct, retail, professional and trade channels to customers in over 115 countries, and serves a multitude of global markets, including automotive, aerospace, electronics, energy, hardware, industrial, and consumer retail.

Learn more at www.apextoolgroup.com.











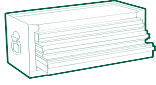





Our portfolio of innovative brands includes:



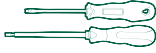

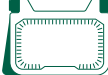

Content

08	Tool Storage		01
34	General Tool Sets		02
46	Ratchets, Sockets & Drive Tools		03
96	Pass-Thru® Ratchet & Socket Systems		04
98	BoltBiter		05
102	Impact Sockets		06
118	Wrenches		07
146	Ratcheting Wrenches		08
170	Torque Wrenches		09
172	Pliers & Crimping Tools		10
190	Cutters & Snips		11
220	Screwdrivers & Nut Drivers		12
244	Hex Keys		13
256	Striking & Struck		14
266	Industrial Work Lights		15
274	Measuring		16
286	Auto Speciality Tools		17
312	Other Tools		18

01

Tool Storage



FLEX MAT

ST95442



Versatile
compartments



Will not scratch
work surface



Non-slip
material



Flexible mat
material



Easy to clean



Multi-purpose
application



Flex Mat

- Versatile compartments keep your tools handy and visible
- Soft Silicon material will not scratch or mar work surface
- Non-slip material ensures mat stays in place
- Flexible mat material bends to any work surface
- Stain resistance makes it easy to clean
- Multi-purpose application improves efficiency



 Nature of this product is subject to wear and tear upon usage. Not covered under Lifetime Warranty.

Article Code	Length (mm)	Width (mm)	Hight (mm)	
ST95442	331.0	190.0	23.0	6

17" 5 Tray Cantilever Tool Box

- All steel constructed tool box opens to 3-tiers with 5 durable trays for stroage and organization
- Dual opening cantilever design allows for quick and easy access to entire tool box
- Equipped with an easy to hold rounded steel handle for comfort and reduced user fatigue
- Manufactured from heavy gauge sheet steel with powder coated finsish



Article Code	Length (mm)	Width (mm)	Hight (mm)	
ST95104ASC	430.0	200.0	200.0	1

14" Metal Tool Box

- Strong comfortable handle
- Tool box made from heavy gauge sheet steel with powder coated finish
- Galvanized phosphate finish to resist corrosion
- Compact size for convenient carry and storage



Article Code	Length (mm)	Width (mm)	Hight (mm)	
ST95101SC	360.0	150.0	115.0	1

16" Metal Tool Box

- Strong comfortable handle
- Tool box made from heavy gauge sheet steel with powder coated finish
- Galvanized phosphate finish to resist corrosion
- Compact size for convenient carry and storage



Article Code	Length (mm)	Width (mm)	Hight (mm)	
ST95115SC	420.0	155.0	120.0	1

17" & 20" Metal Tool Box

- Sturdy carrying handle with two clip locks on the lid
- Tool box made from heavy gauge sheet steel with powder coated finish
- Galvanized phosphate finish to resist corrosion
- Compact size for convenient carry and storage





Article Code	Size	Length (mm)	Width (mm)	Hight (mm)	
ST95102SC	17"	428.0	177.0	184.0	1
ST95103ASC	20"	508.0	218.0	243.0	1

15" & 16" Plastic Tool Box

- Lock and handle made of strong ABS material
- Tool box made of high impact resistant PP material
- ST95162SC: Comes with tool tray for storage and organization



 Nature of this product is subject to wear and tear upon usage. Not covered under Lifetime Warranty.

Article Code	Length (mm)	Width (mm)	Hight (mm)	
ST95161SC	385.0	202.0	140.0	6
ST95162SC	385.0	225.0	203.0	6

21" Plastic Tool Box

- Lock and handle made of strong ABS material
- Tool box made of high impact resistant PP material
- Comes with tool tray for storage and organization



! Nature of this product is subject to wear and tear upon usage. Not covered under Lifetime Warranty.

Article Code	Length (mm)	Width (mm)	Height (mm)	
ST95164SC	530.0	235.0	220.0	6

24" Aluminum Trolley Case

- Double lock structure and anti-shock EVA pad lining for more safety
- Multipurpose tool trays for daily use to organize your tools systematically
- Case is durable, safe and has an impact resistant structure force up to 100 kg (220 lbs), surface panel force up to 50 kg (110 lbs)
- Multipurpose with separators can arbitrarily divide the storage space
- Double lock structure and anti-shock EVR pad lining for more safety



! Nature of this product is subject to wear and tear upon usage. Not covered under Lifetime Warranty.

Article Code	Length (mm)	Width (mm)	Height (mm)	
ST03621	490.0	420.0	230.0	0

13" & 16" Portable Tool Bag

- Waterproof design
- High quality double zipper top
- Reinforced pockets for maximum durability
- Nonslip handles and adjustable padded shoulder straps provide maximum comfort
- Waterproof material resists moisture for long-lasting performance



! Nature of this product is subject to wear and tear upon usage. Not covered under Lifetime Warranty.

Article Code	Length (mm)	Width (mm)	Height (mm)	
ST95181	330.0	215.0	250.0	10
ST95182SC	380.0	300.0	260.0	10

17" Portable Tool Bag

- Waterproof design
- High quality double zipper top
- Internal and external pockets provide a variety of storage and organization options
- Reinforced pockets for maximum durability
- Nonslip handles and adjustable padded shoulder straps provide maximum comfort



Tools not included

 Nature of this product is subject to wear and tear upon usage. Not covered under Lifetime Warranty.

Article Code	Length (mm)	Width (mm)	Hight (mm)	
ST95184SC	440.0	330.0	330.0	10

18" Tool Backpack

- Backpack style is ideal for everyday, hands-free use
- Integrated handle on the outside of the bag is easy to grab
- Interior and exterior pockets provide a variety of storage and organization options
- Made of durable woven material to withstand even the toughest job site



 Nature of this product is subject to wear and tear upon usage. Not covered under Lifetime Warranty.

Article Code	Length (mm)	Width (mm)	Hight (mm)	
ST95198SC	350.0	200.0	450.0	6

23" Trolley Tool Bag

- Made of 600 denier water-resistant material
- Reinforced pockets for maximum durability



Tools not included

 Nature of this product is subject to wear and tear upon usage. Not covered under Lifetime Warranty.

Article Code	Length (mm)	Width (mm)	Hight (mm)	
ST95188	430.0	240.0	380.0	0

4-Pocket Belt Pouch

- Multiple sized pockets offer a variety of storage and organization options
- Constructed with 900-denier nylon construction for maximum strength and durability



Tools not included

 Nature of this product is subject to wear and tear upon usage. Not covered under Lifetime Warranty.

Article Code	Length (mm)	Width (mm)	
ST95211	235.0	110.0	10

8-Pocket Belt Pouch

- Multiple sized pockets offer a variety of storage and organization options
- Constructed with 900-denier nylon construction for maximum strength and durability



 Nature of this product is subject to wear and tear upon usage. Not covered under Lifetime Warranty.

Article Code	Length (mm)	Width (mm)	
ST95213SC	320.0	250.0	10

1 Drawer Utility Cart 33"

- Cart body made of 1.2 mm thickness steel for strength and durability
- Bottom storage tray is ideal for storing larger items
- Top storage tray is ideal for storing commonly used tools and equipment
- Two swivel (with stopper) and two fixed casters with pin rolling bears
- Drawer load capacity 35 kg
- Total load capacity 150 kg



Article Code	Length (mm)	Width (mm)	Height (mm)	
ST95108SC	841.0	414.0	827.0	1

2 Drawer Utility Cart 38"

- Cart body made of 1.2 mm thickness steel for strength and durability
- Easy lid opening and closing with gas charged lift support struts
- Foldable side table for convenience and space saving
- 5" heavy-duty casters; 2 fixed and 2 locking swivel
- Screwdriver compartment for easy convenient storage
- Recessed 'through holes' allow for the secure storage of extra long items like pry bars
- Bottom storage tray is ideal for storing larger items
- Drawer load capacity 35 kg
- Total load capacity 150kg



Article Code	Length (mm)	Width (mm)	Hight (mm)	
ST95118SC	880.0	416.0	1029.0	1

4 Drawer Tool Cart

- Durable PVC handle for comfortable grip
- Cart body made of 1.2 mm thickness steel for strength and durability
- Easy lid opening and closing with gas charged lift support struts
- Bottom storage tray is ideal for storing larger items
- 5" heavy-duty casters; 2 fixed and 2 locking swivel
- Drawer load capacity 35 kg, total load capacity 240 kg



Article Code	Length (mm)	Width (mm)	Hight (mm)	
ST95119SC	877.0	549.0	1015.0	1

4 Drawer Roller Cabinet 27"

- Durable aluminum alloy handle for comfortable grip
- 1.2 mm thickness steel body for strength and durability
- High durability roller tracks enable smooth sliding
- Bottom storage compartment with doors is ideal for storing larger items
- Two swivel and two fixed casters with pin rolling bears
- 5" heavy-duty casters
- Drawer load capacity 35 kg, total load capacity 240 kg
- Drawer size 577x404 mm



Article Code	Length (mm)	Width (mm)	Hight (mm)	
ST95125	692.0	468.0	840.0	1

Mini Roller Cabinet 30"

- Open top tray for easy tools placement
- Shuttle door for easy opening/closing
- See-through net structure on side panels
- Total load capacity 100 kg
- Drawer load capacity 35 kg



Article Code	Length (mm)	Width (mm)	Hight (mm)	
ST9511SC	635.0	390.0	800.0	1

5 Drawer Roller Cabinet 28"

- Four clipped corner design for better strength and durability
- Equipped with EVA foam liners for each drawer and a EVA top mat for convient storage and tool protection
- 45 mm ball bearing slide for exceptional load capacity
- Comes with an aluminium handle providing resistance protection and ease to transport the cabinet
- Durable powder coated finish protects against scratches and marring
- 5" heavy duty casters for smooth running and durability
- Gray color matted surface powder coatings for better scratch resistant
- Drawer load capacity 35 kg, total load capacity 200 kg
- Drawer size 570 x 375 mm



Article Code	Length (mm)	Width (mm)	Hight (mm)	
ST95121	770.0	470 .0	896.0	1

6 Drawer Roller Cabinet 27"

- Durable aluminum alloy handle for comfortable grip
- 1.2 mm thickness steel body for strength and durability
- High durability roller tracks enable smooth sliding
- Two swivel and two fixed casters with pin rolling bears
- 5" heavy-duty casters
- Drawer load capacity 35 kg, total load capacity 240 kg
- Drawer size 577 x 404 mm



Article Code	Length (mm)	Width (mm)	Hight (mm)	
ST95126	692.0	468.0	840.0	1

7 Drawer Roller Cabinet 31"

- Durable PVC handle for comfortable grip
- 1.2 mm thickness steel body for strength and durability
- Screwdriver compartment for easy convenient storage
- High durability roller tracks enable smooth sliding
- Two swivel (with stopper) and two fixed casters with pin rolling bears
- Drawer load capacity 35 kg
- Total load capacity 240 kg
- Drawer size 570 x 375 mm



Article Code	Length (mm)	Width (mm)	Hight (mm)	
ST95107SC	780.0	550.0	1180.0	1

8 Drawer Roller Cabinet 45"

- Durable PVC handle for comfortable grip
- 1.2 mm thickness steel body for strength and durability
- High durability roller tracks enable smooth sliding
- Two swivel (with stopper) and two fixed casters with pin rolling bears
- Drawer load capacity 35 kg
- Total load capacity 240 kg



Article Code	Length (mm)	Width (mm)	Hight (mm)	
ST95109SC	1035.0	457.0	897.0	1

168 Pc. Tool Storage and Tray Set with Tool Trolley

CONTENTS:

- ST09901SJ - 66 Pc. 1/4" Drive 6 Point Metric Socket Tray Set
- ST09903SJ - 27 Pc. 1/2" Drive 6 Point Metric Socket Tray Set
- ST09904-02-10 Pc. Metric Open End and Combination Ratcheting Wrench Tray Set
- ST09906 - 30 Pc. Metric Combination Wrench and Hex Key Tray Set
- ST09907 - 8 Pc. Metric Combination Wrench Tray Set
- ST09909-02-5 Pc. Adjustable Wrench and Pliers Tray Set
- ST09911SJ - 4 Pc. Snap Ring Pliers Tray Set
- ST09912SJ - 4 Pc. Pliers Tray Set
- ST09913SJ - 13 Pc. Combination Screwdriver Tray Set
- ST95121 - 5 Drawer Roller Cabinet 28"



 Please refer to the warranty terms of the individual product

Article Code	Length (mm)	Width (mm)	Hight (mm)	
ST09927	770.0	470.0	896.0	1

168 & 300 PC. TOOL STORAGE AND TRAY SET WITH TOOL TROLLEY

ST09927
ST09928



Contains tools needed for most repairs

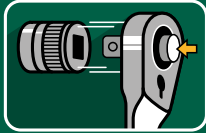

Quick release ratchet



Sockets feature off-corner loading



Ratcheting box end



Precise fit



High performance steel



300 Pc. Tool Storage and Tray Set with Tool Trolley

CONTENTS:

- ST09901SJ - 66 Pc. 1/4" Drive 6 Point Metric Socket Tray Set
- ST09902SJ - 33 Pc. 3/8" Drive 6 Point Metric Socket Tray Set
- ST09903SJ - 27 Pc. 1/2" Drive 6 Point Metric Socket Tray Set
- ST09904-02 - 10 Pc. Metric Open End and Combination Ratcheting Wrench Tray Set
- ST09905 - 10 Pc. Metric Offset Box End Wrench Tray Set
- ST09906 - 30 Pc. Metric Combination Wrench and Hex Key Tray Set
- ST09907 - 8 Pc. Metric Combination Wrench Tray Set
- ST09909-02 - 5 Pc. Adjustable Wrench and Pliers Tray Set
- ST09910 - 8 Pc. File Tray Set
- ST09911SJ - 4 Pc. Snap Ring Pliers Tray Set
- ST09912SJ - 4 Pc. Pliers Tray Set
- ST09913SJ - 13 Pc. Combination Screwdriver Tray Set
- ST09914SJ - 36 Pc. 3/8" and 1/2" Drive 6 Point Metric Impact Socket Tray Set
- ST09915SJ - 26 Pc. 1/2" Drive 6 Point Metric Socket Tray Set
- ST08028 - 19 Pc. Metric Double Ratcheting Combination Wrench Tray Set
- ST95107SC - 7 Drawer Roller Cabinet 31"



 Please refer to the warranty terms of the individual product

Article Code	Length (mm)	Width (mm)	Height (mm)	
ST09928	780.0	550.0	1180.0	1

66 Pc. 1/4" Drive 6 Point Metric Socket Tray Set

CONTENTS:

- 1 - Quick-Release Ratchet
- 14 - 6pt. Metric Sockets 3.5, 4, 4.5, 5, 5.5, 6, 7, 8, 9, 10, 11, 12, 13, 14 mm
- 12 - 6pt. Metric Deep Sockets 4, 4.5, 5, 5.5, 6, 7, 8, 9, 10, 11, 12, 13 mm
- 23 - Bit Sockets
 - Slotted 4, 5.5, 6.5 mm
 - Phillips #1, #2, #3
 - Pozidriv #1, #2, #3
 - Torx® T8, T10, T15, T20, T25, T27, T30, T40
 - Hex 3, 4, 5, 6, 7, 8 mm
- 8 - 25L Bits Phillips #0, #1, #2, #3; Slotted 3, 4, 5, 6 mm
- 8 - Accessories
 - Spinner Handle
 - Wobble Extension Bars 2", 4"
 - Flex Extension Bar 6"
 - T-Handle
 - Universal Joint
 - Magnetic Quick-Release Bit Holder
 - Bit Adapter



Article Code	Length (mm)	Width (mm)	Height (mm)	
ST09901SJ	375.0	185.0	45.0	4

33 Pc. 3/8" Drive 6 Point Metric Socket Tray Set

CONTENTS:

- 1 - Quick-Release Ratchet
- 15 - 6pt. Metric Sockets 8, 9, 10, 11, 12, 13, 14, 15, 16, 17, 18, 19, 21, 22, 24 mm
- 8 - 6pt. Metric Deep Sockets 10, 11, 12, 13, 14, 15, 17, 19 mm
- 3 - Spark Plug Sockets 16, 18, 21 mm
- 6 - Accessories
 - Wobble Extension 10"
 - 3/8" F x 1/4" M Adapter
 - Universal Joint
 - Bit Adapter
 - Locking Extension Bar 3"
 - 1/2" F x 3/8" M 3-Way Adapter



Article Code	Length (mm)	Width (mm)	Height (mm)	
ST09902SJ	375.0	185.0	45.0	4

27 Pc. 1/2" Drive 6 Point Metric Socket Tray Set

CONTENTS:

- 1 - Quick-Release Ratchet
- 17 - 6pt. Metric Sockets 10, 11, 12, 13, 14, 15, 16, 17, 18, 19, 21, 22, 24, 27, 30, 32, 34 mm
- 5 - 6pt. Metric Deep Sockets 10, 13, 17, 19, 22 mm
- 4 - Accessories
 - Wobble Extension Bar 10"
 - Universal Joint
 - Locking Extension Bar 5"
 - 3/8" F x 1/2" M 3-Way Adapter



Article Code	Length (mm)	Width (mm)	Height (mm)	
ST09903SJ	375.0	185.0	45.0	4

26 Pc. 1/2" Drive 6 Point Metric Socket Tray Set

CONTENTS:

- 20 - 6pt. Metric Sockets 8, 9, 10, 11, 12, 13, 14, 15, 16, 17, 18, 19, 20, 21, 22, 23, 24, 27, 30, 32 mm
- 5 - 6pt. Metric Deep Sockets 14, 17, 19, 21, 24 mm
- 1 - Quick-Release Ratchet



Article Code	Length (mm)	Width (mm)	Height (mm)	
ST09915SJ	375.0	185.0	45.0	4

29 Pc. 3/8" Drive 6 Point SAE Socket Tray Set

CONTENTS:

- 11 - 6pt. SAE Sockets
 - 1/4, 5/16, 3/8, 7/16, 1/2, 9/16, 5/8, 11/16, 3/4, 13/16, 7/8"
- 9 - 6pt. SAE Deep Sockets
 - 3/8, 7/16, 1/2, 9/16, 5/8, 11/16, 3/4, 13/16, 7/8"
- 2 - Spark Plug Sockets 5/8, 13/16"
- 7 - Accessories
 - Quick-Release Ratchet
 - Wobble Extension 10"
 - Locking Extension 3"
 - Universal Joint
 - 3/8" F x 1/4" M Adapter
 - Bit Adapter
 - 1/2" F x 3/8" M 3-Way Adapter



Article Code	Length (mm)	Width (mm)	Height (mm)	
ST09934	375.0	185.0	45.0	4

25 Pc. 1/2" Drive 6 Point SAE Socket Tray Set

CONTENTS:

- 15 - 6pt. SAE Sockets 5/16, 3/8, 7/16, 1/2, 9/16, 5/8, 11/16, 3/4, 13/16, 7/8, 15/16, 1, 1-1/16, 1-1/8, 1-1/4"
- 5 - 6pt. SAE Deep Sockets 1/2, 9/16, 5/8, 3/4, 13/16"
- 5 - Accessories
 - Quick-Release Ratchet
 - Wobble Extension 10"
 - Locking Extension 5"
 - Universal Joint
 - 3/8" F x 1/2" M 3-Way Adapter



Article Code	Length (mm)	Width (mm)	Hight (mm)	
ST09528	375.0	185.0	45.0	4

10 Pc. Metric Open End and Combination Ratcheting Wrench Tray Set

CONTENTS:

- 2 - Ratcheting Combination Wrenches 13, 14 mm
- 8 - Double Open End Wrenches 6x7, 8x10, 10x12, 11x13, 12x14, 22x24, 24x27, 30x32 mm



Article Code	Length (mm)	Width (mm)	Hight (mm)	
ST09904-02	375.0	185.0	45.0	4

10 Pc. Metric Offset Double Box End Wrench Tray Set

CONTENTS:

- 6x7, 8x10, 10x12, 11x13, 12x14, 14x17, 17x19, 19x21, 21x23, 24x27 mm



Article Code	Length (mm)	Width (mm)	Hight (mm)	
ST09905	375.0	185.0	45.0	4

30 Pc. Metric Combination Wrench and Hex Key Tray Set

CONTENTS:

- 12 - Combination Wrenches 8, 9, 10, 11, 12, 13, 14, 15, 16, 17, 18, 19 mm
- 9 - Extra Long Ball Point Hex Key Set 1.5, 2, 2.5, 3, 4, 5, 6, 8, 10 mm
- 9 - Long Arm Tamper-Proof Torx® Key Set
T10, T15, T20, T25, T27, T30, T40, T45, T50



Article Code	Length (mm)	Width (mm)	Hight (mm)	
ST09906	375.0	185.0	45.0	4

8 Pc. Metric Combination Wrench Tray Set

CONTENTS:

- 5.5, 6, 7, 20, 21, 22, 23, 24 mm



Article Code	Length (mm)	Width (mm)	Hight (mm)	
ST09907	375.0	185.0	45.0	4

19 Pc. Metric Combination Ratcheting Wrench Tray Set

CONTENTS:

- 15 - Ratcheting Combination Wrenches
5.5, 6, 7, 8, 9, 10, 11, 12, 13, 14, 15, 16, 17, 18, 19 mm
- 1 - Quick Release Adapter 1/4" Dr. 10 mm
- 1 - Quick Release Adapter 3/8" Dr. 13 mm
- 1 - Quick Release Adapter 1/2" Dr. 19 mm
- 1 - Bit Adapter 1/4" Dr. 10 mm



Article Code	Length (mm)	Width (mm)	Hight (mm)	
ST09908	375.0	185.0	45.0	4

19 Pc. Metric Double Ratcheting Combination Wrench Tray Set

CONTENTS:

- 15 - Double Ratcheting Combination Wrenches 5.5, 6, 7, 8, 9, 10, 11, 12, 13, 14, 15, 16, 17, 18, 19 mm
- 1 - 1/4" Dr. x10 mm Quick Release Adapter
- 1 - 3/8" Dr. x13 mm Quick Release Adapter
- 1 - 1/2" Dr. x19 mm Quick Release Adapter
- 1 - 1/4" Dr. x10 mm Bit Adapter



Article Code	Length (mm)	Width (mm)	Hight (mm)	
ST08028	375.0	185.0	45.0	4

27 Pc. SAE Combination Wrench Tray Set

CONTENTS:

- 9 - Combination Wrenches 1/4", 5/16", 3/8", 7/16", 1/2", 9/16", 5/8", 11/16", 3/4"
- 1 - 9 Pc. Extra Long Ball Point Hex Key Set 1.5, 2, 2.5, 3, 4, 5, 6, 8, 10 mm
- 1 - 9 Pc. Long Arm Tamper-Proof Torx® Key Set T10, T15, T20, T25, T27, T30, T40, T45, T50



Article Code	Length (mm)	Width (mm)	Hight (mm)	
ST08034E	375.0	185.0	45.0	4

5 Pc. Adjustable Wrench and Pliers Tray Set

CONTENTS:

- 2 - Adjustable Wrenches 8", 10"
- 1 - Long Nose Pliers 6"
- 1 - Curved Jaw Locking Pliers 7"
- 1 - Long Nose Locking Pliers 6"



Article Code	Length (mm)	Width (mm)	Hight (mm)	
ST09909-02	375.0	185.0	45.0	4

8 Pc. File Tray Set

CONTENTS:

- 1 - Flat File 8"
- 1 - Half-Round File 8"
- 1 - Round File 8"
- 1 - Three Square File 8"
- 1 - Square File 8"
- 3 - 140 mm Needle Files - Flat, Half Round, Round



! Nature of this product is subject to wear and tear upon usage. Not covered under Lifetime Warranty.

Article Code	Length (mm)	Width (mm)	Height (mm)	
ST09910	375.0	185.0	45.0	4

4 Pc. Snap Ring Pliers Tray Set

CONTENTS:

- 1 - External Straight 7"
- 1 - External Curved 7"
- 1 - Internal Straight 7"
- 1 - Internal Curved 7"

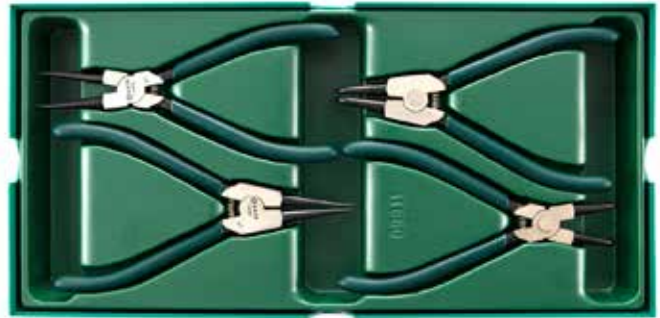

Article Code	Length (mm)	Width (mm)	Height (mm)	
ST09911SJ	375.0	185.0	45.0	4

4 Pc. Pliers Tray Set

CONTENTS:

- 1 - Long Nose 6"
- 1 - Diagonal 6"
- 1 - Linesman 8"
- 1 - Plastic Flush Cutting 6"



Article Code	Length (mm)	Width (mm)	Height (mm)	
ST09912SJ	375.0	185.0	45.0	4

13 Pc. Combination Screwdriver Tray Set

CONTENTS:

- 4 - Precision Slotted 1.0x40 mm, 2.0x40 mm, 2.4x40 mm, 3.0x40 mm
- 2 - Precision Phillips #0x40 mm, #3x40 mm
- 3 - T-Series Slotted 3x75 mm, 5x75 mm, 6x100 mm
- 4 - T-Series Phillips #0x75 mm, #1x75 mm, #2x100 mm, #3x150 mm



Article Code	Length (mm)	Width (mm)	Hight (mm)	
ST09913SJ	375.0	185.0	45.0	4

36 Pc. 3/8" and 1/2" Drive 6 Point Metric Impact Socket Tray Set

CONTENTS:

- 16 - 1/2" Dr. Metric Impact Sockets 10, 11, 12, 13, 14, 15, 16, 17, 18, 19, 21, 22, 24, 27, 30, 32 mm
- 13 - 3/8" Dr. Metric Impact Sockets 7, 8, 9, 10, 11, 12, 13, 14, 15, 16, 17, 18, 19 mm
- 1 - 3/8" Dr. Impact Extension Bar 3"
- 1 - 1/2" Dr. Impact Extension Bar 6"
- 1 - 1/4"Fx3/8"M Impact Adapter
- 1 - 1/2"Fx3/8"M Impact Adapter
- 1 - 3/8"Fx1/2"M Impact Adapter
- 1 - 3/4"Fx1/2"M Impact Adapter
- 1 - 1/2" Dr. Impact Universal Joint



Article Code	Length (mm)	Width (mm)	Hight (mm)	
ST09914SJ	375.0	185.0	45.0	4

4 Pc. Striking Tool Tray Set

CONTENTS:

- 1 - 5 Pc. Punch Set
- 1 - 32 Pc. Feeler Gauge Set
- 1 - Hickory Ball Pein Hammer 24 oz
- 1 - Hickory Soft Face Hammer 35 mm



Article Code	Length (mm)	Width (mm)	Hight (mm)	
ST09932A	375.0	185.0	45.0	4

68 Pc. VDE Tool Set



CONTENTS:

- 2 - 3/8", 1/2" Drive Insulated Quick-Release Teardrop Ratchets
- 8 - 3/8" Drive 6 Point VDE Insulated Sockets 8, 10, 12, 13, 14, 16, 17, 18 mm
- 11 - 1/2" Drive 6 Point VDE Insulated Sockets 10, 11, 12, 13, 14, 16, 17, 19, 21, 22, 24 mm
- 5 - 1/2" Drive VDE Insulated Hex Bit Sockets 4, 5, 6, 8, 10 mm
- 13 - VDE Insulated Open End Wrenches 8, 10, 12, 13, 14, 15, 16, 17, 18, 19, 21, 22, 24 mm
- 13 - VDE Insulated Single Offset Ring Wrenches 8, 10, 12, 13, 14, 15, 16, 17, 18, 19, 21, 22, 24 mm
- 1 - VDE Insulated Adjustable Wrench 8"
- 6 - T-Series VDE Insulated Screwdriver
 - Phillips #0x60 mm, #1x80 mm, #2x100 mm
 - Slotted 2.5x75 mm, 4.0x100 mm, 5.5x125 mm
- 1 - VDE Insulated Long Nose Pliers 8"
- 1 - VDE Insulated Diagonal Pliers 7"
- 1 - VDE Insulated Linesman Pliers 8"
- 1 - VDE Cable Knife
- 2 - Accessories
 - 1/2" Drive VDE Insulated T-Handle
 - 1/2" Drive VDE Insulated Wobble Extensions 5", 10"



Fits ST95125 4 Drawer Roller Cabinet 27" and ST95126 6 Drawer Roller Cabinet 27"

Please refer to the warranty terms of the individual product

Article Code	Length (mm)	Width (mm)	Height (mm)	
SC09928	577.0	404.0	30.0	1

187 Pc. Automotive Master Tool Set

CONTENTS:

- 3 - 1/4", 3/8", 1/2" Drive Quick-Release Ratchets
- 10 - 1/4" Drive 6 Point Sockets 4, 5, 6, 7, 8, 9, 10, 11, 12, 13 mm
- 4 - 1/4" Drive 6 Point Deep Sockets 8, 9, 10, 12 mm
- 9 - 3/8" Drive 6 Point Sockets 11, 12, 13, 14, 15, 16, 17, 18, 19 mm
- 4 - 3/8" Drive 6 Point Deep Sockets 13, 14, 15, 17 mm
- 8 - 3/8" Drive External Torx® Sockets E8, E10, E11, E12, E14, E16, E18, E20
- 3 - 3/8" Drive Metric Spark Plug Sockets 14, 16, 21 mm
- 7 - 1/2" Drive 6 Point Sockets 20, 21, 22, 24, 27, 30, 32 mm
- 2 - 1/2" Drive 6 Point Thin Wall Impact Deep Sockets 17, 19 mm
- 3 - 3/8" Drive Torx® Bit Sockets T20, T30, T40
- 4 - 3/8" Drive Tamper-Proof Torx® Bit Sockets T45, T50, T55, T60
- 4 - 3/8" Drive Hex Bit Sockets 3, 4, 5, 6 mm
- 2 - 3/8" Drive Pozidriv Bit Sockets #1, #2
- 2 - 3/8" Drive Phillips Bit Sockets #1, #2
- 2 - 3/8" Drive Slotted Bit Sockets 5.5, 6.5 mm
- 3 - 1/4" Drive 25L Bits Slotted 4.0, 5.0, 6.5 mm
- 2 - 1/4" Drive 25L Bits Phillips #1, #3
- 4 - 1/4" Drive 25L Bits Hex 3, 4, 5, 6 mm
- 11 - Combination Wrenches 8, 9, 10, 11, 12, 13, 14, 16, 17, 18, 19 mm
- 5 - Flare Nut Wrenches 8x10, 9x11, 10x12, 13x14, 16x17 mm
- 2 - Adjustable Wrenches 8", 10"
- 2 - Acetate Go-Through Screwdrivers Slotted 6x150 mm
Phillips #2x150 mm
- 9 - Acetate Screwdrivers Torx® T20x100 mm, T25x100 mm, T30x100 mm
Slotted 3.2x75 mm, 5x100 mm, 6x150 mm
Phillips #0x75 mm, #1x100 mm, #2x150 mm
- 1 - 10 Pc. Metric Long Hex Key Set
- 1 - 9 Pc. Tamper-Proof Torx® Key Set
- 1 - Long Nose Pliers 6"
- 1 - Diagonal Pliers 6"
- 1 - Linesman Pliers 8"
- 2 - External Snap Ring Pliers, Straight 7", Curved 7"
- 2 - Internal Snap Ring Pliers, Straight 7", Curved 7"

- 1 - Slip Joint Pliers 8"
- 1 - Curved Jaw Locking Pliers 10"
- 1 - Wire Stripper Cutting Pliers 6"
- 1 - T52 Engine Cylinder Head Screw Bit Socket
- 1 - M16 Oil Pan Drain Bit Socket
- 1 - H17 Oil Pan Bit Socket
- 1 - Universal 3-Jaw Oil Filter Wrench
- 1 - Automotive Circuit Tester 6V/12V/24V
- 1 - Shock Absorber Removal Socket
- 1 - Plastic Snap-off Knife, 8-point, 18x100 mm
- 1 - Flexible Magnetic Pick-Up Tool
- 2 - Oil Filter Wrenches 55-75 mm, 75-95 mm
- 1 - Wood Handle Putty Scrape
- 1 - 14 Pc. Feeler Gauge Set 0.05-1.00 mm
- 1 - 5 Pc. Punch Set
- 1 - Fiberglass Ball Pein Hammer 680g / 24oz
- 1 - 1/2" Air Impact Wrench
- 1 - Low Speed Air Tire Buffer
- 1 - 5 Pc. Fine Threaded Extractor Set
- 1 - Multi-Purpose Scissors 8"
- 1 - Mini Digital Multimeter
- 13 - Accessories
 - 1/4", 3/8", 1/2" Drive Universal Joints
 - 3/8" Drive Adapter 1/4"
 - 3/8" Drive 3-Way Adapter 1/2"
 - 1/2" Drive 3-Way Adapter 3/8"
 - 1/4" Drive Wobble Extensions 2"
 - 3/8" Drive Wobble Extension 3", 6"
 - 1/2" Drive Wobble Extensions 5", 10"
 - 1/4" Drive Spinner Handle
 - 1/4" Drive Bit Adapter

Not included: Pen Type Dual-lighting Rechargeable LED Work Light



ST95125

ST95126

Fits ST95125 4 Drawer Roller Cabinet 27" and ST95126 6 Drawer Roller Cabinet 27"

Please refer to the warranty terms of the individual product

Article Code	Length (mm)	Width (mm)	Hight (mm)	
SC09946-1	577.0	404.0	30.0	1

239 Pc. Automotive Master Tool Set

CONTENTS:

- 3 - 1/4", 3/8", 1/2" Drive Quick-Release Ratchets
- 12 - 1/4" Drive 6 Point Sockets 4, 5, 5.5, 6, 7, 8, 9, 10, 11, 12, 13, 14 mm
- 14 - 3/8" Drive 6 Point Sockets 6, 7, 8, 9, 10, 11, 12, 13, 14, 15, 16, 17, 18, 19 mm
- 9 - 3/8" Drive 6 Point Deep Sockets 8, 10, 11, 12, 13, 14, 15, 17, 19 mm
- 10 - 3/8" Drive External Torx® Socket E4, E5, E6, E7, E8, E10, E11, E12, E14, E16
- 2 - 3/8" Drive Metric Spark Plug Sockets 16, 21 mm
- 18 - 1/2" Drive 12 Point Sockets 10, 11, 12, 13, 14, 15, 16, 17, 18, 19, 20, 21, 22, 23, 24, 27, 30, 32 mm
- 2 - 1/2" Drive 6 Point Thin Wall Impact Deep Sockets 17, 19 mm
- 3 - 1/4" Drive Phillips Bit Sockets #1, #2, #3
- 3 - 1/4" Drive Slotted Bit Sockets 4.0, 5.0, 6.5 mm
- 6 - 1/4" Drive Hex Bit Sockets 3, 4, 5, 6, 7, 8 mm
- 7 - 1/4" Drive Torx® Bit Sockets T8, T10, T15, T20, T25, T30, T40
- 5 - 3/8" Drive Hex Bit Sockets 5, 6, 7, 8, 10 mm
- 1 - 3/8" Drive Long Hex Bit Socket 9 mm
- 9 - 3/8" Drive Torx® Bit Socket T15, T20, T25, T27, T30, T40, T45, T50, T55
- 2 - 1/2" Drive Triple Square Bit Sockets M10, M12
- 2 - 1/2" Drive Long Triple Square Bit Sockets M8, M10, M12, M14
- 3 - 1/2" Drive Hex Bit Sockets 12, 14, 19 mm
- 17 - Combination Wrenches 8, 9, 10, 11, 12, 13, 14, 15, 16, 17, 18, 19, 20, 21, 22, 23, 24 mm
- 4 - Deep Offset Double Box End Wrenches 10x11, 12x13, 16x17, 18x19 mm
- 6 - Flex Head Ratcheting Wrenches 8, 10, 13, 15, 16, 18 mm
- 3 - Flare Nut Wrenches 9x11, 13x14, 16x17 mm
- 1 - Adjustable Wrench 10"
- 2 - Acetate Go-Through Screwdrivers Slotted 6x150 mm
Phillips #2x150 mm
- 1 - 10 Pc. Metric Long Hex Key Set
- 1 - 9 Pc. Tamper-Proof Torx® Key Set
- 16 - Acetate Screwdrivers Torx® T8x75, T10x100, T15x100, T20x100 mm,
T25x100 mm, T27x100, T30x100, T40x100 mm
Slotted 3.2x75 mm, 5x100 mm, 5x300 mm,
6x150 mm
Phillips #0x75 mm, #1x75 mm, #2x150 mm,
#2x300 mm
- 1 - Long Nose Pliers 6"
- 1 - Diagonal Pliers 6"
- 1 - Linesman Pliers 8"
- 1 - Slip Joint Pliers 8"
- 1 - Groove Joint Pliers 10"
- 1 - Curved Jaw Locking Pliers 10"
- 1 - German Style External Snap Ring Pliers, Straight 7"
- 1 - German Style Internal Snap Ring Pliers, Straight 7"
- 1 - T52 Engine Cylinder Head Screw Bit Socket
- 1 - M16 Oil Pan Drain Bit Socket
- 1 - H17 Oil Pan Bit Socket
- 2 - End Cap Oil Filter Wrenches 36, 74 mm
- 1 - 14 Pc. Feeler Gauge Set 0.05-1.00 mm
- 1 - Multi-Purpose Scissors 8"
- 1 - Flexible Magnetic Pick-Up Tool
- 1 - Air Blow Gun 250 mm
- 1 - Pry Bars Driver
- 1 - Tape Measure Metric/SAE Scale 5 m/16ft x 19 mm
- 1 - Fiberglass Ball Pein Hammer 680g / 24oz
- 1 - Dead Blow Soft Rubber Hammer 55 mm
- 1 - 5 Pc. Punch Set
- 1 - 5 Pc. Interior Trims Remover Set
- 1 - Plastic Snap-off Knife, 13-point, 9x80 mm
- 13 - Accessories:
 - 1/4" Drive Spinner Handle
 - 1/4", 1/2" Drive Universal Joint
 - 1/4" Drive Wobble Extensions 2", 4"
 - 3/8" Drive Wobble Extensions 3", 6", 10"
 - 1/2" Drive Wobble Extensions 5", 10"
 - 3/8" Drive Adapter 1/2"
 - 3/8" Drive 3-Way Adapter 1/2"
 - 1/2" Drive Flex Handle / Breaker Bar 15"



Fits ST95126 6 Drawer Roller Cabinet 27"

Please refer to the warranty, terms of the individual product

Article Code	Length (mm)	Width (mm)	Height (mm)	
SC09947-1	577.0	404.0	30.0	1

249 Pc. Master Body Tool Set

CONTENTS:

- 3 - 1/4", 3/8", 1/2" Dr. Quick-Release Ratchets
- 13 - 1/4" Drive 6 Point Sockets 4, 4.5, 5, 5.5, 6, 7, 8, 9, 10, 11, 12, 13, 14 mm
- 12 - 3/8" Drive 6 Point Sockets 8, 9, 10, 11, 12, 13, 14, 15, 16, 17, 18, 19 mm
- 13 - 3/8" Drive 6 Point Deep Sockets 10, 11, 12, 13, 14, 15, 16, 17, 18, 19, 20, 21, 22 mm
- 2 - 3/8" Drive Metric Spark Plug Sockets 14, 16, 21 mm
- 20 - 1/2" Drive 6 Point Sockets 8, 9, 10, 11, 12, 13, 14, 15, 16, 17, 18, 19, 20, 21, 22, 23, 24, 27, 30, 32 mm
- 19 - Combination Wrenches 8, 9, 10, 11, 12, 13, 14, 15, 16, 17, 18, 19, 20, 21, 22, 23, 24, 25, 27 mm
- 1 - Adjustable Wrench 10"
- 1 - 9 Pc. Metric Extra Long Ball Point Hex Key Set
- 1 - 9 Pc. Tamper-Proof Torx® Key Set
- 2 - Acetate Go-Through Screwdrivers Slotted 6x150 mm
Phillips #2x150 mm
- 8 - Acetate Screwdrivers Slotted 3.2x75 mm, 5x100 mm, 6x38 mm,
6x100 mm
Phillips #0x75 mm, #1x75 mm, #2x38 mm,
#2x100 mm
- 5 - Drive 30L Bits Slotted 5.5, 6.5, 8, 10, 12 mm
- 1 - Drive 70L Long Bit Slotted 8 mm
- 3 - Drive 30L Bits Phillips #1, #2, #3
- 1 - Drive 70L Long Bit Phillips #2
- 8 - Drive 30L Bits Tamper-Proof Torx® T20, T25, T30, T40, T45, T50, T55, T60
- 8 - Drive 70L Long Bits Torx® T20, T25, T27, T30, T40, T45, T50, T55
- 5 - Drive 30L Bits Triple Square M5, M6, M8, M10, M12
- 7 - Drive 70L Long Bits Triple Square M5, M6, M8, M10, M12, M14, M16
- 7 - Drive 30L Bits Hex 4, 5, 6, 7, 8, 10, 12 mm
- 8 - Drive 70L Long Bits Hex 4, 5, 6, 7, 8, 10, 12, 14 mm
- 1 - Long Nose Pliers 6"
- 1 - Diagonal Pliers 6"
- 1 - Linesman Pliers 8"
- 1 - Slip Joint Pliers 8"
- 1 - Curved Jaw Locking Pliers 10"
- 2 - German Style External Snap Ring Pliers, Straight 7", Curved 7"
- 2 - German Style Internal Snap Ring Pliers, Straight 7", Curved 7"
- 1 - Long Nose Locking Pliers 9"
- 1 - Welding Clamp Locking Pliers 9"
- 1 - Metal Sheet Clamp Locking Pliers 8"
- 1 - C-Clamps Locking Pliers 11"
- 1 - Flat File 8" Second Cut
- 1 - Half Round File 8" Second Cut
- 1 - Round File 8" Second Cut
- 1 - Triangular File 8" Second Cut
- 1 - Diamond Pointed Flat File 3x140 mm
- 1 - Diamond Pointed Half-Round File 3x140 mm
- 1 - Diamond Pointed Round File 3x140 mm
- 1 - T52 Engine Cylinder Head Screw Bit Socket
- 1 - M16 Oil Pan Drain Bit Socket
- 1 - H17 Oil Pan Bit Socket
- 1 - Oil Filter Wrench 63-102 mm
- 1 - Automotive Circuit Tester 6V/12V/24V
- 1 - 14 Pc. Feeler Gauge Set 0.05-1.00 mm
- 1 - Flexible Magnetic Pick-Up Tool
- 1 - Fiberglass Ball Pein Hammer 680g / 24oz
- 1 - Dead Blow Soft Rubber Hammer 55 mm
- 1 - Curved Pein and Finishing Hammer
- 1 - Straight Pein and Finishing Hammer
- 1 - Pick and Finishing Hammer
- 1 - Anvil Dolly
- 1 - Wedge Dolly
- 1 - Toe Dolly
- 1 - Pry Bumping Spoon
- 1 - Wood Handle Putty Scraper
- 1 - 5 Pc. Punch Set
- 1 - 5 Pc. Fine Threaded Tap Extractor Set
- 1 - 5 Pc. Handy Remover Set
- 1 - Air Blow Gun 100 mm
- 1 - Tape Measure Metric/SAE Scale 5 m/16ft x 19 mm
- 1 - Plastic Snap-off Knife, 13-point, 9 x 80 mm
- 16 - Accessories:
 - 1/4", 3/8", 1/2" Drive Universal Joint
 - 1/4" Drive Wobble Extensions 2", 4"
 - 3/8" Drive Wobble Extensions 3", 6"
 - 1/2" Drive Wobble Extensions 5", 10"
 - 1/4" Drive Flex Extension
 - 1/4" Drive Adapter 3/8"
 - 3/8" Drive Adapter 1/2"
 - 1/2" Drive Adapter 3/8"
 - 1/2" Drive OffSet Handle
 - 3/8", 1/2" Drive Bit Adapter 5/16"



 Please refer to the warranty terms of the individual product

Fits ST95126 6 Drawer Roller Cabinet 27"

Article Code	Length (mm)	Width (mm)	Hight (mm)	
SC09930-1	577.0	404.0	30.0	1

368 Pc. Master Tool Set

CONTENTS:

- 3 - 1/4", 3/8", 1/2" Dr. Quick-Release Ratchets
- 13 - 1/4" Drive 6 Point Sockets 4, 4.5, 5, 5.5, 6, 7, 8, 9, 10, 11, 12, 13, 14 mm
- 10 - 1/4" Drive 6 Point Deep Sockets 4, 5, 6, 7, 8, 9, 10, 11, 12, 13 mm
- 12 - 3/8" Drive 6 Point Sockets 8, 9, 10, 11, 12, 13, 14, 15, 16, 17, 18, 19 mm
- 10 - 3/8" Drive 6 Point Deep Sockets 8, 9, 10, 11, 12, 13, 14, 15, 17, 19 mm
- 8 - 3/8" Drive External Torx® Socket E8, E10, E11, E12, E14, E16, E18, E20
- 20 - 1/2" Drive 6 Point Sockets 8, 9, 10, 11, 12, 13, 14, 15, 16, 17, 18, 19, 20, 21, 22, 23, 24, 27, 30, 32 mm
- 20 - 1/2" Drive 12 Point Sockets 8, 9, 10, 11, 12, 13, 14, 15, 16, 17, 18, 19, 20, 21, 22, 23, 24, 27, 30, 32 mm
- 14 - 1/2" Drive 6 Point Deep Sockets 10, 11, 12, 13, 14, 15, 16, 17, 18, 19, 20, 21, 22, 24 mm
- 4 - 1/2" Drive 12 Point Deep Sockets 10, 12, 17, 19 mm
- 3 - 3/8" Drive Spark Plug Sockets 14, 16, 21 mm
- 4 - 1/2" Drive 6 Point Impact Sockets 17, 19, 21, 23 mm
- 3 - 1/4" Drive Slotted Bit Sockets 4.0, 5.5, 6.5 mm
- 2 - 3/8" Drive Slotted Bit Sockets 5.5, 6.5 mm
- 3 - 1/4" Drive Phillips Bit Sockets #1, #2, #3
- 3 - 3/8" Drive Phillips Bit Sockets #1, #2, #3
- 7 - 1/4" Drive Torx® Bit Sockets T8, T10, T15, T20, T25, T27, T30, T40
- 9 - 3/8" Drive Torx® Bit Sockets T10, T15, T20, T25, T27, T30, T40, T45, T50
- 6 - 1/4" Drive Hex Bit Sockets 3, 4, 5, 6, 7, 8 mm
- 7 - 3/8" Drive Hex Bit Sockets 3, 4, 5, 6, 7, 8, 10 mm
- 23 - Combination Wrenches 6, 7, 8, 9, 10, 11, 12, 13, 14, 15, 16, 17, 18, 19, 20, 21, 22, 23, 24, 25, 27, 30, 32 mm
- 13 - Double Open End Wrenches 6x7, 8x10, 10x12, 12x14, 13x15, 13x16, 14x17, 16x18, 17x19, 19x21, 22x24, 24x27, 30x32 mm
- 11 - Deep Offset Double Box End Wrenches 10x12, 12x14, 13x15, 13x16, 14x17, 16x18, 17x19, 19x21, 19x22, 22x24, 24x27
- 12 - Pipe Wrench 6, 7, 8, 9, 10, 11, 12, 13, 14, 15, 16, 17 mm
- 1 - Adjustable Wrenches 10"
- 1 - 9 Pc. Metric Extra Long Ball Point Hex Key Set
- 1 - 9 Pc. Tamper-Proof Torx® Key Set
- 2 - Acetate Go-Through Screwdrivers Slotted 6x150 mm, Phillips #2x150 mm
- 8 - Acetate Screwdrivers Slotted 3.2x75 mm, 5x100 mm, 6x38 mm, 6x100 mm Phillips #0x75 mm, #1x75 mm, #2x38 mm, #2x100 mm
- 4 - Cushion Grip Go-Through Screwdrivers Slotted 8x150 mm, 8x200 mm Phillips #3x150 mm, 3x200 mm
- 6 - Drive 30L Bits Tamper-Proof Torx® T20, T25, T30, T40, T45, T50
- 8 - Drive 70L Long Bits Torx® T20, T25, T27, T30, T40, T45, T50, T55
- 5 - Drive 30L Bits Triple Square M5, M6, M8, M10, M12
- 5 - Drive 70L Long Bits Triple Square M5, M6, M8, M10, M12
- 7 - Drive 30L Bits Hex 4, 5, 6, 7, 8, 10, 12 mm
- 7 - Drive 70L Long Bits Hex 4, 5, 6, 7, 8, 10 mm
- 1 - Long Nose Pliers 6"
- 1 - Diagonal Pliers 6"
- 1 - Linesman Pliers 8"
- 1 - Slip Joint Pliers 8"
- 1 - Curved Jaw Locking Pliers 10"
- 2 - German Style External Snap Ring Pliers, Straight 7", Curved 7"
- 2 - German Style Internal Snap Ring Pliers, Straight 7", Curved 7"
- 1 - T52 Engine Cylinder Head Screw Bit Socket
- 1 - M16 Oil Pan Drain Bit Socket
- 1 - H17 Oil Pan Bit Socket
- 1 - Flexible Magnetic Pick-Up Tool
- 1 - 5 Pc. Interior Trims Remover Set
- 1 - 5 Pc. Punch Set
- 1 - 5 Pc. Fine Threaded Tap Extractor Set
- 1 - Pry Bars Driver
- 1 - Automotive Circuit Tester 6V/12V/24V
- 1 - Air Blow Gun 100 mm
- 1 - Oil Filter Wrench 63-102 mm
- 1 - 14 Pc. Feeler Gauge Set 0.05-1.00 mm
- 1 - Fiberglass Ball Pein Hammer 680g / 24oz
- 1 - Dead Blow Soft Rubber Hammer 55 mm
- 1 - Tape Measure Metric/SAE Scale 5 m/16ft x19 mm
- 1 - Plastic Snap-off Knife, 13-point, 9x80 mm
- 24 - Accessories:
 - 1/4" Drive Spinner Handle
 - 1/4", 3/8", 1/2" Drive Universal Joint
 - 1/4" Drive Wobble Extensions 2", 4"
 - 3/8" Drive Wobble Extensions 3", 6", 10"
 - 1/2" Drive Wobble Extensions 5", 10"
 - 1/2" Drive OffSet Handle
 - 1/4", 3/8", 1/2" Drive T-Handle
 - 1/4" Drive Adapter 3/8"
 - 3/8" Drive Adapter 1/4"
 - 3/8" Drive Adapter 1/2"
 - 1/2" Drive Adapter 3/8"
 - 3/8" Drive 3-Way Adapter 1/2"
 - 1/2" Drive 3-Way Adapter 3/8"
 - 3/8" Drive Bit Adapter 5/16"
 - 1/2" Drive Bit Adapter 5/16"
 - 1/4" Drive Flex Extension



Please refer to the warranty terms of the individual product

Fits ST95126 6 Drawer Roller Cabinet 27"

Article Code	Length (mm)	Width (mm)	Height (mm)	
SC09931-1	577.0	404.0	30.0	1

103 Pc. General Tool Set

CONTENTS:

- 2 - 1/4", 1/2" Dr. Quick-Release Ratchets
- 7 - 1/4" Dr. 6pt. Metric Sockets 5, 5.5, 6, 7, 8, 9, 10 mm
- 12 - 1/2" Dr. 12pt. Metric Sockets 8, 10, 11, 12, 13, 17, 19, 20, 22, 24, 30, 32 mm
- 1 - 1/2" Dr. 6pt. Metric Deep Socket 17 mm
- 16 - 1/4" Dr. Bit Sockets Hex 3, 4, 5, 6, 8 mm
Phillips #1, #2
Slotted 4, 5.5, 6.5 mm
Torx® T10, T15, T20, T25, T30, T40
- 4 - 1/2" Dr. Long Bit Sockets Torx® T25, T27, T30, T40
- 6 - 1/2" Dr. Long Bit Sockets Hex 5, 6, 7, 8, 12, 14 mm
- 9 - Double Open End Wrenches 8x10, 10x12, 11x13, 12x14, 14x17, 16x18, 17x19, 21x23, 22x24 mm
- 13 - Acetate Screwdrivers Torx® T10x100, T15x100, T20x100, T25x100, T27x100, T30x100 mm
Slotted 6x38, 3.2x75, 5x100, 6x150 mm
Phillips #1x75, #2x38, #2x100 mm
- 2 - T-Series Go-Through Screwdrivers Slotted 8x150 mm
Phillips #3x150 mm
- 1 - Adjustable Wrench 8"
- 1 - Curved Jaw Quick-Release Pliers 10"
- 1 - Long Nose Locking Pliers 6"
- 1 - Metal Sheet Clamping Locking Pliers 8"
- 1 - C-Clamp Locking Pliers 11"
- 1 - Plastic Rivet Removal Pliers
- 1 - Standard Bumping Hammer 310 g
- 1 - Curved Pein and Finishing Hammer 305 g
- 1 - Hickory Dead Blow Hammer 40 mm
- 1 - Hickory Ball Pein Hammer 24 oz
- 3 - Dollies Anvil, Wedge, Toe
- 2 - Aviation Snips Left Cut 10", Right Cut 10"
- 1 - Aluminum Hack Saw 12"
- 1 - Pinch Bar 18x400 mm
- 4 - Files 6" Half Round Bastard Cut, 6" Half Round Smooth Cut
6" Round Second Cut, 6" Three Square Second Cut
- 10 - Accessories
9pc. Metric Long Arm Ball Point Hex Key Set
1/4" Dr. Wobble Extension Bars 2", 4"
1/4" Dr. Spinner Handle
1/4" Dr. T-Handle
1/2" Dr. Wobble Extension Bars 5", 10"
1/2" Dr. T-Handle
1/4", 1/2" Dr. Universal Joints



Fits ST95121 5 Drawer Roller Cabinet 28" and ST95107SC 7 Drawer Roller Cabinet 31"

Please refer to the warranty terms of the individual product

Article Code	Length (mm)	Width (mm)	Hight (mm)	
ST95208S	570.0	375.0	30.0	1

171 Pc. General Tool Set

CONTENTS:

- 3 - 1/4", 3/8", 1/2" Dr. Quick-Release Ratchets
- 10 - 1/4" Dr. 6pt. Metric Sockets 5, 5.5, 6, 7, 8, 9, 10, 11, 12, 13 mm
- 3 - 1/4" Dr. 6pt. Metric Deep Sockets 6, 7, 10 mm
- 9 - 3/8" Dr. 6pt. Metric Sockets 8, 9, 10, 11, 12, 13, 14, 15, 16 mm
- 3 - 3/8" Dr. 6pt. Metric Deep Sockets 13, 15, 16 mm
- 10 - 1/2" Dr. 6pt. Metric Sockets 10, 14, 15, 16, 17, 18, 19, 21, 22, 27 mm
- 2 - 1/2" Dr. 6pt. Metric Deep Sockets 17, 19 mm
- 11 - 1/2" Dr. 12pt. Metric Sockets 10, 11, 12, 13, 17, 19, 20, 22, 24, 30, 32 mm
- 4 - 1/4" Dr. Bit Sockets Hex 5, 6 mm, Pozidriv #2, Slotted 5.5 mm
- 5 - 3/8" Dr. Bit Sockets Torx® T10, T15, T20, T25, T30
- 5 - 1/2" Dr. Bit Sockets Hex 5, 6, 7, 8, 10 mm
- 4 - 1/2" Dr. Long Bit Sockets Torx® T25, T27, T30, T45
- 6 - 1/2" Dr. Long Bit Sockets Hex 5, 6, 7, 8, 12, 14 mm
- 3 - 1/2" Dr. Long Bit Sockets Triple Square M6, M8, M10
- 4 - 1/2" Dr. 6pt. Metric Impact Sockets 17, 19, 21, 22 mm
- 16 - Combination Wrenches 7, 10, 11, 12, 13, 14, 15, 16, 17, 19, 20, 21, 22, 23, 24, 27 mm
- 9 - Double Open End Wrenches
8x10, 10x12, 11x13, 12x14, 14x17, 16x18, 17x19, 21x23, 22x24 mm
- 7 - Deep Offset Double Box End Wrenches
8x9, 10x11, 12x13, 14x15, 18x19, 20x22, 24x27 mm
- 15 - Acetate Screwdrivers Torx® T10x100, T15x100, T20x100, T25x100,
T27x100, T30x100 mm
Slotted 6x38, 3.2x75, 5x100, 6x150, 8x150 mm
Phillips #1x75, #2x38, #2x100, #3x150 mm
- 1 - Slip Joint Pliers 8"
- 1 - Long Nose Pliers 6"
- 1 - Diagonal Pliers 5"
- 1 - Linesman Pliers 7"
- 1 - External Snap Ring Straight Pliers 7"
- 1 - External Snap Ring Curved Pliers 7"
- 1 - Internal Snap Ring Straight Pliers 7"
- 1 - Internal Snap Ring Curved Pliers 7"
- 1 - Hickory Ball Pein Hammer 24 oz
- 1 - Air Blow Gun 100 mm
- 1 - 1/2" Dr. Air Impact Wrench
- 5 - End Cap Oil Filter Wrench 65, 74, 76, 90, 93 mm
- 1 - Universal 3-Jaw Oil Filter Wrench 63-102 mm
- 1 - Oil Filter Wrench 75-95 mm
- 1 - Dial Torque Wrench 300 Nm
- 22 - Accessories
9pc. Metric Long Arm Ball Point Hex Key Set
16pc. Feeler Gauge Set
1/4" Dr. Wobble Extension Bars 2", 4"
1/4" Dr. Spinner Handle
1/4" Dr. Flex Extension Bar 6"
3/8" Dr. Locking Extension Bar 6", 10"
3/8" Dr. Spark Plug Sockets 16, 21 mm
3/8" Dr. Flex Extension Bar 8"
1/2" Dr. Wobble Extension Bars 5", 10"
1/2" Dr. T-Handle
1/4", 3/8", 1/2" Dr. Universal Joints
3/8"Fx1/4"M, 1/2"Fx3/8"M Socket Adapters
Japanese Style Plug R1/4"
Flexible Magnetic Pickup Tool 400 mmx1 kg
T-Handle 6pt. Socket 10 mm



 Please refer to the warranty terms of the individual product

Fits ST95107SC 7 Drawer Roller Cabinet 31"

Article Code	Length (mm)	Width (mm)	Height (mm)	
ST95207S	570.0	375.0	30.0	1



SATA

ORIGINAL STRENGTH
FOR COMMERCIAL
**Increased
Cleaning**

WD-40

General Tool Sets



9 Pc. VDE Insulated Screwdriver and Pliers Set



Article Code	Content	
ST09262U	1 - VDE Insulated Linesman Pliers 8" 1 - VDE Insulated Diagonal Pliers 6" 1 - VDE Insulated Long Nose Pliers 6" 6 - G-Series VDE Insulated Screwdrivers Slotted 2.5x75 mm, 4x100 mm, 5.5x125 mm Philips # 0x60 mm, # 1x80 mm, # 2x100 mm	4



5 Pc. Basic Tool Set

Article Code	Content	
ST06002	1 - Adjustable wrench 8" 1 - T series double-ended screwdriver # 2 & 6 mmx100 mm 1 - Long nose pliers 6" 1 - Tape measure 3 m x 16 mm 1 - Snap-off knife	12

Please refer to the warranty terms of the individual product



7 Pc. Basic Tool Set

Article Code	Content	
ST06001SJ	1 - Linesman pliers 7" 1 - Adjustable Wrench 8" 1 - T series double-ended screwdriver # 2 & 6 mmx10 mm 1 - Circuit Tester 1 - Tape Measure 2 m x 13 mm 1 - Utility Knife 1 - Claw Hammer with steel handle 8 oz / 227 g	8

Please refer to the warranty terms of the individual product



9 Pc. Basic Tool Set

Article Code	Content	
ST06004	1 - Adjustable wrench 8" 1 - T series double-ended screwdriver # 2 & 6 mmx10 mm 1 - Linesman pliers 6" 1 - Long nose pliers 6" 1 - Tape measure 3 m x 16 mm 1 - Claw hammer with steel handle 8 oz / 227 g 1 - Circuit tester 1 - Aluminum alloy flashlight 1 - Snap-off knife	8

Please refer to the warranty terms of the individual product



11 Pc. Driver's Tool Set

Article Code	Content	
ST06011	1- 1/2" Dr. L Type Extendable Socket Wrench 2- 1/2" Dr. Double-end Sockets 17x19, 21x23 mm 1- Linesman Pliers 7" 1- Long Nose Pliers 6" 1- Adjustable Wrench 8" 1- Acetate Screwdriver Slotted 6x100 mm 1- Acetate Screwdriver Phillips #2x100 mm 1- Tape Measure 3 m x 16 mm 1- Utility Knife 18 x 100 mm 1- LED Flashlight	4



 Please refer to the warranty terms of the individual product

19 Pc. Basic Tool Set

Article Code	Content	
ST04110SC	1- Linesman pliers 6" 8- Long hex keys 1.5, 2, 2.5, 3, 4, 5, 6, 8 mm 1- Claw hammer with wooden handle 8 oz / 227 g 1- Mini saw 6" 2- Slotted screwdriver 3x75 mm, 6x100 mm 2- Phillips screwdriver # 0x75 mm, # 2x100 mm 1- Tape measure 3 m x 16 mm 1- Circuit tester 1- Snap-off knife 1- Adjustable wrench 8"	6



 Please refer to the warranty terms of the individual product

25 Pc. Basic Tool Set

Article Code	Content	
ST06008SJ	2 - Acetate Screwdrivers Slotted 5x100 mm Phillips #1x100 mm 1- Circuit Tester 1- Adjustable Wrench 8" 1- Long Nose Pliers 6" 1- Linesman Pliers 6" 1- Insulation Tape 1- Fine Point Tweezer 1- Tape Measure 3 m x 16 mm 1- Utility Knife 1- Scissors 1- Aluminum Flashlight 1- Mini Hacksaw 2- Mini Hacksaw Blades 1- Hickory Claw Hammer 8oz / 227 g 1- 8 pc. Metric Hex Key Fold-Up Set 1.5, 2, 2.5, 3, 4, 5, 6, 8 mm 1- Plastic Box	4



 Please refer to the warranty terms of the individual product

35 Pc. 1/4" and 3/8" Drive E-Torx® Socket and Wrench Set

Article Code	Content	
ST09010SJ	7 - 1/4" Shank Tamper-Proof Torx® Bits T10, T15, T20, T25, T27, T30, T40 12 - 3/8" Dr. E-Torx® Sockets E4, E5, E6, E7, E8, E10, E11, E12, E14, E16, E18, E20 11 - 3/8" Dr. Torx® Bit Sockets T10, T15, T20, T25, T27, T30, T40, T45, T50, T55, T60 4 - E-Torx® Wrenches E6 x E8, E10 x E12, E14 x E18, E20 x E24 1 - 1/4" Shank x 3/8" Dr. Bit Adapter	12



21 Pc. 1/2" Drive 6 Point and 12 Point Metric/SAE Socket Wrench Set

Article Code	Content	
ST09077SJ	1 - Quick-Release Ratchet 8 - Metric 6pt. Sockets 10, 11, 12, 13, 14, 15, 17, 19 mm 4 - SAE 12pt. Sockets 3/8", 7/16", 1/2", 9/16" 1 - Spark Plug Socket 16 mm 5 - Metric Combination Wrenches 10, 11, 12, 13, 14 mm 2 - Wobble Extensions 5", 10"	4



25 Pc. 1/2" Drive 6 Point and 12 Point Metric Socket and Wrench Set

Article Code	Content	
ST09506SJ	1 - 1/2" Quick-Release Ratchet 12 - 1/2" 12pt. Metric Sockets 10, 11, 12, 13, 14, 15, 16, 17, 18, 19, 22, 24 mm 3 - 1/2" 6pt. Metric Deep Sockets 13, 17, 19 mm 1 - 1/2" Spark Plug Socket 16 mm 5 - Metric Combination Wrenches 10, 11, 12, 13, 14 mm 3 - Accessories 1/2" Wobble Extension 10" 1/2" Universal Joint 3/8" F x 1/2" M 3-Way Adapter	4



26 Pc. 1/2" Drive 6 Point Metric Socket Tool Set

Article Code	Content	
ST09502SJ	1 - Quick-Release Ratchet 9 - 6pt. Metric Sockets 10, 12, 14, 16, 17, 19, 21, 22, 24 mm 7 - Combination Wrenches 8, 10, 12, 14, 16, 17, 19 mm 4 - Acetate Screwdrivers, Slotted 6x100 mm, 6x150 mm Phillips #2x100 mm, #2x150 mm 5 - Accessories Wobble Extension Bar 5" Flex Handle 15" Long Nose Pliers 6" Diagonal Pliers 6" Linesman Pliers 7"	4



33 Pc. 1/2" Drive 6 Point Metric Socket Wrench Set

Article Code	Content	
ST09099	1 - Quick-Release Ratchet 21 - 6pt. Metric Sockets 8, 9, 10, 11, 12, 13, 14, 15, 16, 17, 18, 19, 20, 21, 22, 23, 24, 27, 30, 32, 34 mm 5 - 12pt. Metric Sockets, 10, 12, 14, 17, 19 mm 2 - Metric Quad Box Wrenches 8x10+12x13 mm, 16x17+18x19 mm 4 - Accessories, Wobble Extension Bars 5", 10" 3/8"Fx1/2"M 3-Way Adapter Universal Joint	4



42 Pc. 3/8" Drive 6 Point Metric 120XP Socket Wrench Set

Article Code	Content	
ST09054	1 - 3/8" Drive 120xp Ratchet 1 - 3/8" Universal Joint 3 - 3/8" Wobble Extensions 3", 6", 10" 16 - 3/8" Metric 6pt. Sockets 7, 8, 9, 10, 11, 12, 13, 14, 15, 16, 17, 18, 19, 21, 22, 24 mm 14 - 3/8" Metric 6pt. Deep Sockets 8, 9, 10, 11, 12, 13, 14, 15, 16, 17, 18, 19, 21, 22 mm 7 - 120xp Metric Ratcheting Wrenches 8, 10, 12, 13, 14, 15, 18 mm	3



32 Pc. 3/8" Drive 6 Point SAE 120XP Socket and Wrench Set

Article Code	Content	
ST09044	1 - 3/8" 120xp Ratchet 1 - 3/8" Universal Joint 3 - 3/8" Wobble Extensions 3", 6", 10" 11 - 3/8" SAE 6pt. Sockets 1/4", 5/16", 3/8", 7/16", 1/2", 9/16", 5/8", 11/16", 3/4", 13/16", 7/8" 9 - 3/8" SAE 6pt. Deep Sockets 3/8", 7/16", 1/2", 9/16", 5/8", 11/16", 3/4", 13/16", 7/8" 7 - 120xp SAE Ratcheting Wrenches 5/16", 3/8", 7/16", 1/2", 9/16", 5/8", 3/4"	3



52 Pc. 1/4" Drive 6 Point Metric Master Tool Set

Article Code	Content	
ST09505SJ	1 - Quick Release Ratchet 14 - 6pt. Metric Sockets 3.5, 4, 4.5, 5, 5.5, 6, 7, 8, 9, 10, 11, 12, 13, 14 mm 6 - 6pt. Metric Deep Sockets 8,9,10,11,12, 13 mm 18 - 5/16" Shank 30L Bits Slotted 4, 5.5, 6.5 mm Phillips #1, #2, #3, T10, T15, T20, T25, T30, T40 Hex 3, 4, 5, 6, 7, 8 mm 1 - Mini Long Nose Plier 5" 1 - Mini Diagonal Plier 5" 1 - Curved Jaw Locking Plier 5" 1 - Adjustable Wrench 6" 3 - Screwdrivers Slotted 3.2x150 mm Phillips # 0x75 mm Torx® T8x75 mm 5 - Accessories Spinner Handle Sliding T-Bar Wobble Extension Bars 2", 4" Universal Joint Bit Coupler	4



58 Pc. 3/8" Drive 6 Point Metric Mechanic's Tool Set

Article Code	Content	
ST09516SJ	1 - 3/8" Dr. Quick Release Ratchet 14 - 3/8" Dr. 6pt. Metric Sockets 6, 7, 8, 9, 10, 11, 12, 13, 14, 15, 16, 17, 18, 19 mm 1 - 9 Pc. Metric Ball Point Hex Key Set 1.5, 2, 2.5, 3, 4, 5, 6, 8, 10 mm 10 - Combination Wrenches 8, 10, 11, 12, 13, 14, 15, 16, 18, 19 mm 1 - Metric Combination Ratcheting Wrench 17 mm 1 - Adjustable Wrench 8" 7 - Acetat Screwdrivers Slotted 6x38 mm, 32x75 mm, 5x100 mm Phillips #2 x38 mm, #0 x75 mm, #1 x100 mm, #2 x150 mm 1 - Linesman pliers 8" 1 - Long Nose Pliers 6" 1 - 5 pc. Snap Ring Pliers Set 1 - Tape Measure 3 m x 16 mm 1 - 23 pc. Feeler Gauge Set 0.02 mm - 1 mm 1 - Straight Steel Ruler 150 mm 1 - Hickory Ball Pein Hammer 16 oz / 454 g 1 - Magnetic Pickup Tool 1 - Snap-off Knife 1 - Aluminum Alloy Flashlight (with 2 AA batteries) 1 - Universal Joint	2



76 Pc. 1/4" and 1/2" Drive 6 Point Metric Socket Wrench Set

Article Code	Content	
ST09519SJ	2 - 1/4", 1/2" Dr. Quick-Release Ratchets 7 - 1/4" Dr. 6pt. Metric Sockets 8, 9, 10, 11, 12, 13, 14 mm 18 - 1/4" Dr. Bit Sockets Slotted 4, 5.5, 6.5 mm Phillips #1, #2 Pozidriv #1, #2 Torx® T8, T10, T15, T20, T25, T30, T40 Hex 3, 4, 5, 6 mm 12 - 1/2" Dr. 6pt. Metric Sockets 8, 10, 12, 13, 14, 17, 19, 22, 24, 27, 30, 32 mm 9 - Combination Wrenches 8, 10, 11, 12, 13, 14, 17, 19, 22 mm 15 - 5/16" Shank 30L Bits Slotted 8, 10, 12 mm Phillips #3, #4 Pozidriv #3, #4 Torx® T40, T45, T50, T55 Hex 8, 10, 12, 14 mm 2 - 1/2" Dr. Spark Plug Sockets 16, 21 mm 11 - Accessories 1/4" Dr. T-Handle 1/4" Dr. Flex Extension 1/4" Dr. Wobble Extension Bars 2", 4" 1/2" Dr. Wobble Extension Bars 5", 10" 1/4", 1/2" Dr. Universal Joints 1/4" Dr. Spinner Handle 1/2" Dr. T-Handle 5/16" Shank x 1/2" Dr. Bit Adapter	3



124 Pc. 1/4", 3/8" & 1/2" Drive 6 Point Metric/SAE 6 Point Socket Wrench Set

Article Code	Content	
ST09014SJ	3 - 1/4", 3/8", 1/2" Dr. Quick-Release Ratchets 10 - 1/4" Dr. 6pt. Metric Sockets 4, 5, 6, 7, 8, 9, 10, 11, 12, 13 mm 4 - 1/4" Dr. 6pt. Metric Deep Sockets 8, 9, 10, 12 mm 11 - 3/8" Dr. 6pt. Metric Sockets 9, 10, 11, 12, 13, 14, 15, 16, 17, 18, 19 mm 4 - 3/8" Dr. 6pt. Metric Deep Socket 13, 14, 15, 17 mm 8 - 3/8" Dr. E-Torx® Sockets E8, E10, E11, E12, E14, E16, E18, E20 17 - 3/8" Dr. Bit Sockets Slotted 5.5, 6.5 mm Phillips #1, #2 Torx® T20, T30, T40 Tamper-Proof Torx® T45, T50, T55, T60 Hex 3, 4, 5, 6 mm Pozidriv #1, #2, #3 41 - Accessories 1/4" Dr. Spinner Handle 1/4" Dr. Wobble Extension Bar 2" 3/8" Dr. Wobble Extension Bars 3", 6" 1/2" Dr. Wobble Extension Bars 5", 10" 1/4", 3/8", 1/2" Dr. Universal Joints 3/8" F x 1/4" M, 3/8" F x 1/2" M Adapters 1/4" Shank x 1/4" Dr. Bit Adapter 1/4" Shank Bits Slotted 4, 5, 6.5 mm Phillips #1, #3 Tamper-Proof Torx® T10, T15, T20, T25, T27, T30, T40 Hex 3, 4, 5, 6 mm Pozidriv #1, #2 9 Pc. Metric Hex Key Set 1.5, 2, 2.5, 3, 4, 5, 6, 8, 10 mm Circuit Tester Universal 3-Way Oil Filter Wrench 63-102 mm 2 - 3/8" Dr. Spark Plug Sockets 16, 21 mm 7 - 1/2" Dr. 6pt. Metric Sockets 20, 21, 22, 24, 27, 30, 32 mm 1 - 1/2" Dr. Triple Square Bit Socket M10 11 - Metric Combination Wrenches 8, 9, 10, 11, 12, 13, 14, 16, 17, 18, 19 mm 1 - Metric X-BEAM® Combination Wrench 13 mm 2 - Acetate Go-Through Screwdrivers Slotted 6x100 mm Phillips #2x100 mm	2



128 Pc. 1/4", 3/8" and 1/2" Drive 6 Point Metric Socket Wrench Set

Article Code	Content	
ST09014A	1 - 3/8" Dr. Quick-Release Ratchet 1 - 1/4" Dr. Quick-Release Ratchet 1 - 1/2" Dr. Quick-Release Ratchet 10 - 1/4" Dr. 6pt. Metric Sockets 4, 5, 6, 7, 8, 9, 10, 11, 12, 13, 14 mm 5 - 1/4" Dr. 6pt. Metric Deep Sockets 8, 9, 10, 11, 12 mm 11 - 3/8" Dr. 6pt. Metric Sockets 9, 10, 11, 12, 13, 14, 15, 16, 17, 18, 19 mm 7 - 3/8" Dr. 6pt. Metric Deep Socket 13, 14, 15, 16, 17, 18, 19 mm 8 - 3/8" Dr. E-Torx® Sockets E8, E10, E11, E12, E14, E16, E18, E20 17 - 3/8" Dr. Bit Sockets Slotted 5.5, 6.5 mm Phillips #1, #2 Torx® T20, T30, T40 Tamper-Proof Torx® T45, T50, T55 T60 Hex 3, 4, 5, 6 mm Pozidriv #1, #2, #3 2 - 3/8" Dr. Spark Plug Sockets 16, 21 mm 7 - 1/2" Dr. 6pt. Metric Sockets 20, 21, 22, 24, 27, 30, 32 mm 1 - 1/2" Dr. Triple Square Bit Socket M10 12 - Metric Combination Wrenches 8, 9, 10, 11, 12, 13, 14, 15, 16, 17, 18, 19 mm 1 - Metric X-BEAM® Combination Wrench 13 mm 2 - Acetate Go-Through Screwdrivers Slotted 6x100 mm Phillips #2x100 mm 41 - Accessories 1/4" Dr. Spinner Handle 1/4" Dr. Wobble Extension Bar 2" 3/8" Dr. Wobble Extension Bars 3", 6" 1/2" Dr. Wobble Extension Bars 5", 10" 1/4", 3/8", 1/2" Dr. Universal Joints 3/8" F x 1/4" M, 3/8" F x 1/2" M Adapters 1/4" Shank x 1/4" Dr. Bit Adapter 1/4" Shank Bits Slotted 4, 5, 6.5 mm Phillips #1, #3 Tamper-Proof Torx® T10, T15, T20, T25, T27, T30, T40 Hex 3, 4, 5, 6 mm Pozidriv #1, #2 9 Pc. Metric Extra Long Hex Key Set 1.5, 2, 2.5, 3, 4, 5, 6, 8, 10 mm Circuit Tester Universal 3-Way Oil Filter Wrench 63-102 mm	2

150 Pc. 1/4", 3/8" and 1/2" Drive 6 and 12 Point Metric/SAE Socket Wrench Set

Article Code	Content	
ST09510L	3 - 1/4", 3/8", 1/2" Dr. Quick-Release Ratchets 10 - 1/4" Dr. 6pt. Metric Sockets 4, 5, 6, 7, 8, 9, 10, 11, 12, 13 mm 10 - 1/4" Dr. 6pt. SAE Sockets 5/32, 3/16, 7/32, 1/4, 9/32, 5/16, 11/32, 3/8, 7/16, 1/2" 6 - 1/4" Dr. 6pt. Metric Deep Sockets 4, 5, 6, 7, 8, 9 mm 11 - 3/8" Dr. 6pt. Metric Sockets 9, 10, 11, 12, 13, 14, 15, 16, 17, 18, 19 mm 9 - 3/8" Dr. 6pt. SAE Sockets 3/8, 7/16, 1/2, 9/16, 5/8, 11/16, 3/4, 13/16, 7/8" 6 - 3/8" Dr. 6pt. Metric Deep Sockets 10, 11, 12, 13, 14, 15 mm 2 - 3/8" Dr. Spark Plug Sockets 16, 21 mm 22 - 3/8" Dr. Bit Sockets Slotted 4, 5.5, 6.5 mm Phillips #1, #2, #3 Pozidriv #1, #2, #3 Torx® T20, T30, T40 Tamper-Proof Torx® T45, T50, T55, T60 Hex 3, 4, 5, 6, 8, 10 mm 8 - 3/8" Dr. 6pt. E-Torx® Sockets E8, E10, E11, E12, E14, E16, E18, E20 4 - 1/2" Dr. 6pt. Metric Impact Sockets 17, 19, 21, 23 mm 7 - 1/2" Dr. 12pt. Metric Sockets 20, 21, 22, 24, 27, 30, 32 mm 4 - 1/2" Dr. 12pt. SAE Sockets 15/16, 1, 1-1/16, 1-1/4" 6 - 1/2" Dr. 6pt. Metric Deep Sockets 10, 12, 13, 14, 17, 19 mm 12 - Metric Combination Wrenches 8, 9, 10, 11, 12, 13, 14, 15, 16, 17, 18, 19 mm 3 - Metric Double Box Ratcheting Wrenches 8x10, 12x13, 17x19 mm 27 - Accessories 1/4" Dr. Bit Adapter 1/4" Dr. Spinner Handle 1/4" Dr. Wobble Extension Bar 4" 3/8" Dr. Locking Extension Bars 3", 6" 1/2" Dr. Wobble Extension Bar 5" 1/2" Dr. Locking Extension Bar 10" 1/4", 3/8", 1/2" Dr. Universal Joints 1/4" Shank Tamper-Proof Torx® Bits T10, T15, T20, T25, T27, T30, T40 10 Pc. Metric Hex Key Set 1.5, 2, 2.5, 3, 4, 5, 5.5, 6, 8, 10 mm	1



150 PC. 1/4", 3/8" & 1/2" DRIVE 6 & 12 POINT METRIC/SAE SOCKET WRENCH SET

ST09510L

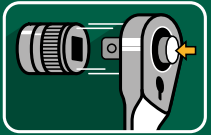

Quick release ratchet

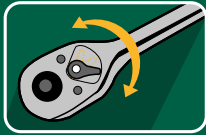

Flush reversing lever



Single hex (6 pt.) fastener end



Sockets feature off-corner loading

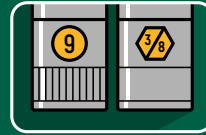

Large easy ID size markings

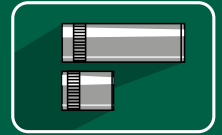

Standard & deep sockets



METRIC

1/4"

3/8"

1/2"



150 PIECES

150 Pc. 1/4", 3/8" and 1/2" Drive 6 and 12 Point Metric/SAE Master Tool Set

Article Code	Content	
ST09510SJ	3 - 1/4", 3/8", 1/2" Dr. Quick-Release Ratchets 10 - 1/4" Dr. 6pt. Metric Sockets 4, 5, 6, 7, 8, 9, 10, 11, 12, 13 mm 10 - 1/4" Dr. 6pt. SAE Sockets 5/32, 3/16, 7/32, 1/4, 9/32, 5/16, 11/32, 3/8, 7/16, 1/2" 6 - 1/4" Dr. 6pt. Metric Deep Sockets 4, 5, 6, 7, 8, 9 mm 11 - 3/8" Dr. 6pt. Metric Sockets 9, 10, 11, 12, 13, 14, 15, 16, 17, 18, 19 mm 9 - 3/8" Dr. 6pt. SAE Sockets 3/8, 7/16, 1/2, 9/16, 5/8, 11/16, 3/4, 13/16, 7/8" 6 - 3/8" Dr. 6pt. Metric Deep Sockets 10, 11, 12, 13, 14, 15 mm 2 - 3/8" Dr. Spark Plug Sockets 16, 21 mm 22 - 3/8" Dr. Bit Sockets Slotted 4, 5.5, 6.5 mm Phillips #1, #2, #3; Pozidriv #1, #2, #3 Torx® T20, T30, T40 Tamper-Proof Torx® T45, T50, T55, T60 Hex 3, 4, 5, 6, 8, 10 mm 8 - 3/8" Dr. 6pt. E-Torx® Sockets E8, E10, E11, E12, E14, E16, E18, E20 8 - 1/2" Dr. 12pt. Metric Sockets 20, 21, 22, 24, 27, 30, 32, 34 mm 4 - 1/2" Dr. 12pt. SAE Sockets 15/16, 1, 1-1/16, 1-1/4" 6 - 1/2" Dr. 6pt. Metric Deep Sockets 10, 12, 13, 14, 17, 19 mm 12 - Metric Combination Wrenches 8, 9, 10, 11, 12, 13, 14, 15, 16, 17, 18, 19 mm 3 - Metric Double Box Ratcheting Wrenches 8 x 10, 12 x 13, 17 x 19 mm 3 - Go-Through Screwdrivers Slotted 6 x 150 mm, 8 x 200 mm Phillips #2 x 150 mm 27 - Accessories 1/4" Dr. Bit Adapter 1/4" Dr. Spinner Handle 1/4" Dr. Wobble Extension Bar 4" 1/4" Dr. Extension Bar 2" 3/8" Dr. Locking Extension Bars 3", 6" 1/2" Dr. Wobble Extension Bar 5" 1/2" Dr. Locking Extension Bar 10" 1/4", 3/8", 1/2" Dr. Universal Joints 1/4" Shank Tamper-Proof Torx® Bits T10, T15, T20, T25, T27, T30, T40 9 Pc. Metric Extra Long Hex Key Set 1.5, 2, 2.5, 3, 4, 5, 6, 8, 10 mm	1

70 Pc. Metric Cantilever Tool Box and Tray Set

Article Code	Content	
ST95104A70-6	1 - 5" Cantilever Tool Box 1 - 1/2" Dr. Quick-Release Ratchet 17 - 1/2" Dr. Metric Sockets* 8, 9, 10, 11, 12, 13, 14, 17, 19, 20, 21, 22, 23, 24, 27, 30, 32 mm 3 - 1/2" Dr. Metric Deep Sockets* 17, 19, 21 mm 11 - Combination Wrenches 8, 9, 10, 11, 12, 13, 14, 17, 19, 21, 24 mm 4 - Acetate Screwdrivers Slotted 5 x 75 mm, 6 x 150 mm Phillips #1 x 75 mm, #2 x 150 mm 1 - Adjustable Wrench 12" 1 - Long Nose Pliers 6" 1 - Diagonal Pliers 6" 1 - Linesman Pliers 7" 1 - Hickory Ball Pein Hammer 24 oz 28 - Accessories 1/2" Dr. Wobble Extension Bars 5", 10" 1/2" Dr. Universal Joint 1/2" Dr. Offset Handle 260 mm 8 Pc. Metric Foldup Hex Key Set 16 Pc. Feeler Gauge Set	1
ST95104A70	12 Point Metric Standard and Deep Sockets	



150 PC. 1/4", 3/8" & 1/2" DRIVE 6 & 12 POINT METRIC/SAE MASTER TOOL SET

ST09510SJ

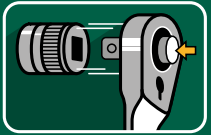

Quick release ratchet

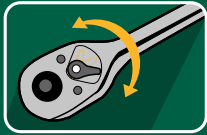

Flush reversing lever



Single hex (6 pt.) fastener end



Sockets feature off-corner loading

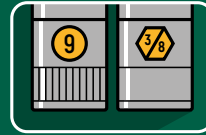

Large easy ID size markings

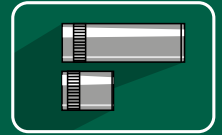

Standard & deep sockets



METRIC

1/4"

3/8"

1/2"



150 PIECES



SATA 11911

SATA

CR2-V

Ratchets, Sockets & Drive Tools

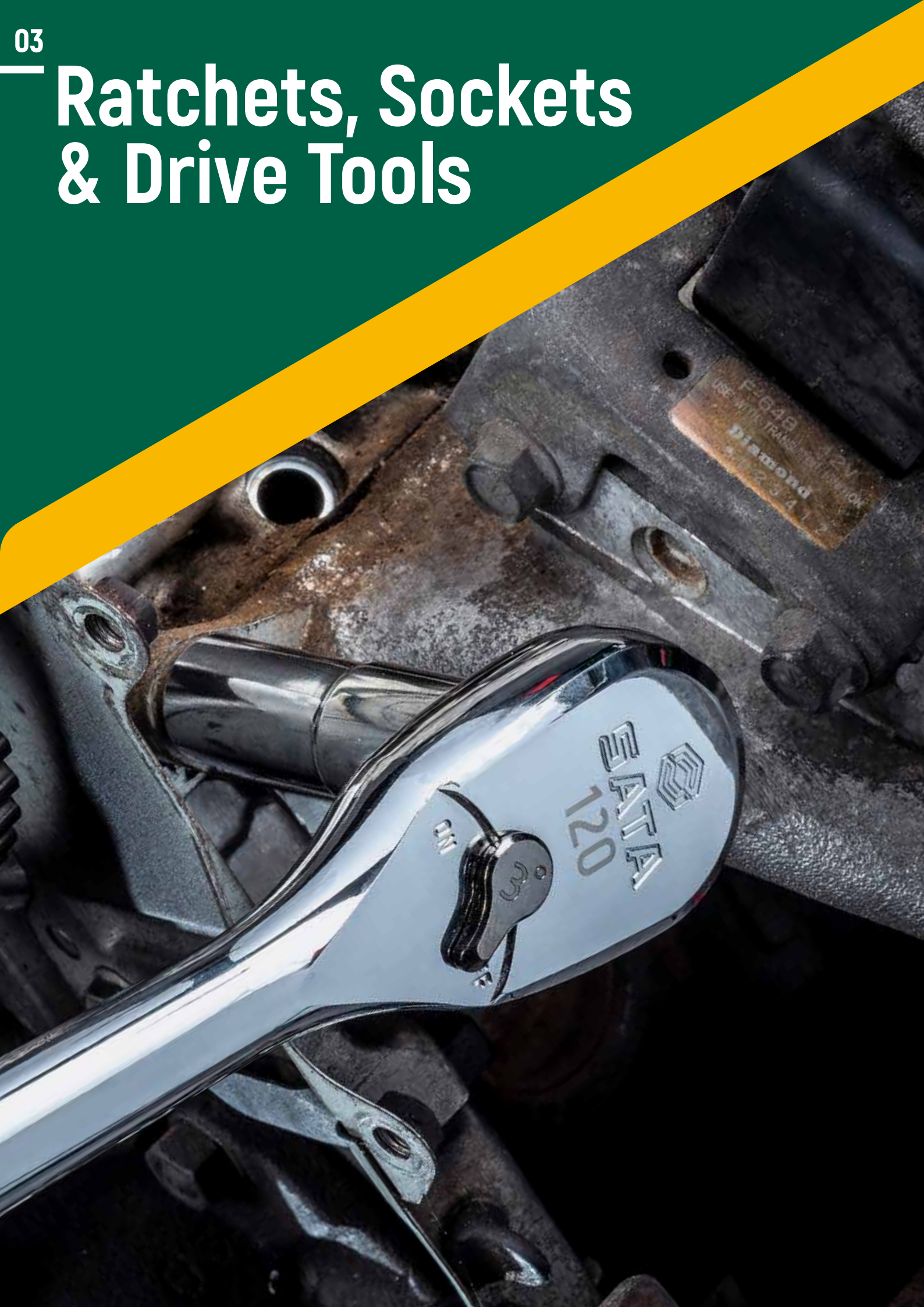

3 PC. 120XP 1/4", 3/8" AND 1/2" RATCHET SET

ST13975



Designed with 120 positions

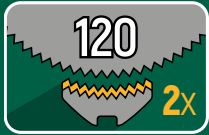

Two double stacked 60-tooth pawls



Resists dirt infiltration

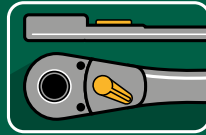

Teardrop, low-profile head

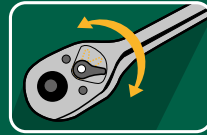

Flush reversing lever

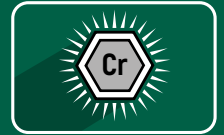

Full polish chrome finish



1/4"

3/8"

1/2"



3 Pc. 120XP 1/4", 3/8" and 1/2" Ratchet Set

Article Code	Content	
ST13975	1- 120XP Dr. Full Polish Ratchet 1/4" 1- 120XP Dr. Full Polish Ratchet 3/8" 1- 120XP Dr. Full Polish Ratchet 1/2"	12



13 Pc. 1/4" Drive 6 Point Metric Socket Set

Article Code	Content	
ST09521L	1- Quick-Release Round Head Ratchet 11- 6pt. Metric Sockets 4, 5, 6, 7, 8, 9, 10, 11, 12, 13, 14 mm 1- Wobble Extension Bar 2"	6



20 Pc. 1/4" Drive 6 Point Metric Socket Set

Article Code	Content	
ST09522	1- Quick-Release Round Head Ratchet 13- 6pt. Metric Sockets 4, 4.5, 5, 5.5, 6, 7, 8, 9, 10, 11, 12, 13, 14 mm 4- 6pt. Metric Deep Sockets 8, 10, 12, 13 mm 1- Extension Bar 2" 1- Spinner Handle	12



21 Pc. 1/4" Drive 6 Point Metric Socket Set

Article Code	Content	
ST09521-02	1- Quick-Release Ratchet 11- 6pt. Metric Sockets 4, 5, 6, 7, 8, 9, 10, 11, 12, 13, 14 mm 6- Shank 25L Bits Slotted 4, 5, 6 mm Phillips #1, #2, #3 3- Accessories Extension 2" Spinner Handle 6" Bit Adapter	12



36 Pc. 1/4" Drive 6 Point Metric Socket Set

Article Code	Content	
ST09001SJ	1 - Quick-Release Ratchet 14 - 6pt. Metric Sockets 3.5, 4, 4.5, 5, 5.5, 6, 7, 8, 9, 10, 11, 12, 13, 14 mm 5 - 6pt. Metric Deep Sockets 8, 10, 11, 12, 13 mm 9 - Shank 25L Bits Slotted 4, 5, 6 mm Phillips #1, #3 Hex 3, 4, 5, 6 mm 7 - Accessories Spinner Handle Wobble Extension Bars 2", 4" Flex Extension 6" Bit Adapter T-Handle Universal Joint	12



52 Pc. 1/4" Drive 6 Point Metric Socket Set

Article Code	Content	
ST09002SJ	1 - Quick-Release Ratchet 14 - 6pt. Metric Sockets 3.5, 4, 4.5, 5, 5.5, 6, 7, 8, 9, 10, 11, 12, 13, 14 mm 4 - 6pt. Metric Deep Sock- ets 8, 10, 12, 13 mm 18 - Bit Sockets Slotted 4, 5.5, 6.5 mm Phillips #1, #2 Pozidriv #1, #2 Torx® T10, T15, T20, T25, T30, T40 Hex 3, 4, 5, 6, 8 mm 9 - Shank 25L Bits Slotted 4, 5, 6.5 mm Phillips #1, #3 Hex 3, 4, 5, 6 mm 6 - Accessories Spinner Handle T-Handle Universal Joint Wobble Extension Bars 2", 4" Bit Adapter	12



25 Pc. 1/4" Drive 6 Point SAE Socket Set

Article Code	Content	
ST09098SJ	1 - Quick-Release Ratchet 10 - 6pt. SAE Sockets 5/32, 3/16, 7/32, 1/4, 9/32, 5/16, 11/32, 3/8, 7/16, 1/2" 10 - 6pt. SAE Deep Sockets 5/32, 3/16, 7/32, 1/4, 9/32, 5/16, 11/32, 3/8, 7/16, 1/2" 4 - Accessories Flex Handle 10" Wobble Extension 2", 6" Universal Joint	6



65 Pc. 1/4" and 3/8" Drive 6 Point Metric/SAE Socket Set

Article Code	Content	
ST09011SJ	1- 3/8" Dr. Quick-Release Ratchet 12- 1/4" Dr. 6pt. Metric Sockets 4, 4.5, 5, 5.5, 6, 7, 8, 9, 10, 11, 12, 13 mm 10- 1/4" Dr. 6pt. SAE Sockets 5/32, 3/16, 7/32, 1/4, 9/32, 5/16, 11/32, 3/8, 7/16, 1/2" 18- 1/4" Shank 25L Bits Slotted 4, 5.5, 6.5 mm Phillips #1, #2, #3 Torx® T10, T15, T20, T25, T30, T40 Hex 3, 4, 5, 6, 7, 8 mm 10- 3/8" Dr. 6pt. Metric Sockets 10, 11, 12, 13, 14, 15, 16, 17, 18, 19 mm 8- 3/8" Dr. 6pt. SAE Sockets 3/8, 7/16, 1/2, 9/16, 5/8, 11/16, 3/4, 13/16" 1- 3/8" Dr. Spark Plug Socket 16 mm 5- Accessories 3/8" Dr. Wobble Extension Bar 3" 3/8" Dr. Universal Joint 1/4" Shank x 1/4" Dr. Bit Adapter 3/8" F x 1/4" M Adapter 1/4" Dr. Spinner Handle	3





88 Pc. 1/4" and 1/2" Drive 6 Point Metric Socket Set

Article Code	Content	
ST09013SJ	2- 1/4", 1/2" Dr. Quick-Release Ratchets 13- 1/4" Dr. 6pt. Metric Sockets 3.5, 4, 4.5, 5, 5.5, 6, 7, 8, 9, 10, 11, 12, 13 mm 6- 1/4" Dr. 6pt. Metric Deep Sockets 8, 9, 10, 11, 12, 13 mm 17- 1/4" Dr. Bit Sockets Slotted 4, 5.5, 6.5 mm Phillips #1, #2 Pozidriv #1, #2 Torx® T8, T10, T15, T20, T25, T31 Hex 3, 4, 5, 6 mm 2- 1/2" Dr. Spark Plug Sockets 16, 21 mm 17- 1/2" Dr. 6pt. Metric Sockets 10, 11, 12, 13, 14, 15, 16, 17, 18, 19, 20, 21, 22, 24, 27, 30, 32 mm 6- 1/2" Dr. 6pt. Metric Deep Sockets 14, 15, 16, 17, 18, 19 mm 15- 5/16" Shank 30L Bits Slotted 8, 10, 12 mm Phillips #3, #4 Pozidriv #3, #4 Torx® T40, T45, T50, T55 Hex 8, 10, 12, 14 mm 10- Accessories 1/4" Dr. T-Handle 1/4" Dr. Wobble Extension Bars 2", 4" 1/2" Dr. Wobble Extension Bars 5", 10" 1/4", 1/2" Dr. Universal Joints 3/8" F x 1/2" M 3-Way Adapter 1/4" Dr. Spinner Handle 5/16" Shank x 1/2" Dr. Bit Adapter	3



18 Pc. 1/4" and 1/2" Drive Bit Socket Sets

Article Code	Description	
ST09051SJ	18 - Pc. 1/4" and 1/2" Dr. Bit Socket Set 6 - 1/4" Dr. Bit Sockets Slotted 4, 5.5, 6.5 mm Phillips #1, #2, #3 6 - 1/2" Dr. 50L Triple Square Bit Sockets M5, M6, M8, M10, M12, M14 6 - 1/2" Dr. 100L Triple Square Bit Sockets M5, M6, M8, M10, M12, M14	5

Article Code	Description	
ST09052SJ	18 - Pc. 1/4" and 1/2" Dr. Torx® Bit Socket Set 6 - 1/4" Dr. Torx® Bit Sockets T10, T15, T20, T25, T30, T40 6 - 1/2" Dr. 50L Torx® Bit Sockets T30, T40, T45, T50, T55, T60 6 - 1/2" Dr. 100L Torx® Bit Sockets T30, T40, T45, T50, T55, T60	5

Article Code	Description	
ST09053SJ	18 - Pc. 1/4" and 1/2" Dr. Hex Bit Socket Set 6 - 1/4" Dr. Hex Bit Sockets 3, 4, 5, 6, 7, 8 mm 6 - 1/2" Dr. 50L Hex Bit Sockets 5, 6, 7, 8, 10, 12 mm 6 - 1/2" Dr. 100L Hex Bit Sockets 5, 6, 7, 8, 10, 12 mm	5



3 Pc. 1/4", 3/8" and 1/2" Metric Socket Tray Set

- Space saving design preferred by, and designed for, professionals
- Helps to keep your workspace organized
- Large markings offer easy size identification
- Clearly marked socket sizes on pins for instant size identification
- Sturdy, break resistant pins have professional strength
- Quick to read size markers on the top of each pin
- Each tray can hold both standard and deep sockets



3 Pc. 1/4", 3/8" and 1/2" SAE Socket Tray Set

- Space saving design preferred by, and designed for, professionals
- Helps to keep your workspace organized
- Large markings offer easy size identification
- Clearly marked socket sizes on pins for instant size identification
- Sturdy, break resistant pins have professional strength
- Quick to read size markers on the top of each pin
- Each tray can hold both standard and deep sockets



Article Code	
ST95401	9

Article Code	
ST95400	9

1/4" Drive 6 Point Socket

- Single hex (6 pt.) fastener end design
- Off-corner loading design reduces fastener rounding
- Large markings offer easy size identification
- Double line (SAE) & knurled line (MM) to easily identify standard and metric sockets
- Manufactured to industrial specifications assuring a thin wall design with precise nut end dimensions
- Heat treated for long lasting durability
- Bright, full polish chrome finish easily wipes clean and resists corrosion
- Chrome vanadium alloy steel (Cr-V) for exceptional strength and durability
- Meets or exceeds ASME B107.110

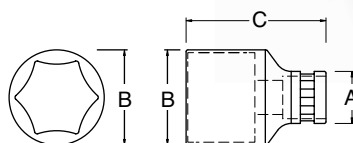

⚠ These sockets accessories should never be used on power drivers, pneumatic impact wrench and/or extenders.

Article Code	Fastener Size	Overall Length (mm) (Dimension C)	Drive End (mm) (Dimension A)	Wrench End (mm) (Dimension B)	
ST11301SC	3.5 mm	24.5	11.8	6.1	6
ST11302SC	4.0 mm	24.5	11.8	7.0	6
ST11303SC	4.5 mm	24.5	11.8	7.3	6
ST11304SC	5.0 mm	24.5	11.8	8.0	6
ST11305SC	5.5 mm	24.5	11.8	8.6	6
ST11306SC	6.0 mm	24.5	11.8	9.2	6
ST11307SC	7.0 mm	24.5	11.8	10.7	6
ST11308SC	8.0 mm	24.5	11.8	11.8	6
ST11309SC	9.0 mm	24.5	13.0	13.0	6
ST11310SC	10.0 mm	24.5	14.2	14.2	6
ST11311SC	11.0 mm	24.5	15.8	15.8	6
ST11312SC	12.0 mm	24.5	16.8	16.8	6
ST11313SC	13.0 mm	24.5	17.5	17.5	6
ST11314SC	14.0 mm	24.5	19.5	19.5	6
ST11101SC	5/32"	24.5	11.8	7.0	6
ST11102SC	3/16"	24.5	11.8	7.8	6
ST11103SC	7/32"	24.5	11.8	8.5	6
ST11104SC	1/4"	24.5	11.8	9.5	6
ST11105SC	9/32"	24.5	11.8	10.7	6
ST11106SC	5/16"	24.5	11.8	11.8	6
ST11107SC	11/32"	24.5	12.5	12.5	6
ST11108SC	3/8"	24.5	13.8	13.8	6
ST11109SC	17/16"	24.5	15.7	15.7	6
ST11110SC	1/2"	24.5	17.3	17.3	6

1/4" Drive 6 Point Deep Socket

- Single hex (6 pt.) fastener end design
- Off-corner loading design reduces fastener rounding
- Deep socket to reach more fasteners
- Large markings offer easy size identification
- Double line (SAE) & knurled line (MM) to easily identify standard and metric sockets
- Manufactured to industrial specifications assuring a thin wall design with precise nut end dimensions
- Heat treated for long lasting durability
- Bright, full polish chrome finish easily wipes clean and resists corrosion
- Chrome vanadium alloy steel (Cr-V) for exceptional strength and durability
- Meets or exceeds ASME B107.110

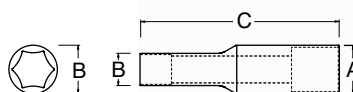

These sockets accessories should never be used on power drivers, pneumatic impact wrench and/or extenders.

Article Code	Fastener Size	Overall Length (mm) (Dimension C)	Drive End (mm) (Dimension A)	Wrench End (mm) (Dimension B)	
ST11401SC	4.0 mm	49.0	11.9	6.7	6
ST11402SC	5.0 mm	49.0	11.9	8.0	6
ST11403SC	6.0 mm	49.0	11.9	9.2	6
ST11404SC	7.0 mm	49.0	11.9	10.8	6
ST11405SC	8.0 mm	49.0	11.9	11.9	6
ST11406SC	9.0 mm	49.0	13.1	13.1	6
ST11407SC	10.0 mm	49.0	14.6	14.6	6
ST11408SC	11.0 mm	49.0	15.9	15.9	6
ST11409SC	12.0 mm	49.0	16.9	16.9	6
ST11410SC	13.0 mm	49.0	17.9	17.9	6
SC11201	3/16"	49.0	11.9	7.9	6
SC11202	7/32"	49.0	11.9	8.9	6
SC11203	1/4"	49.0	11.9	9.9	6
SC11204	9/32"	49.0	11.9	11.0	6
SC11205	5/16"	49.0	11.9	11.9	6
SC11206	11/32"	49.0	13.1	13.1	6
SC11207	3/8"	49.0	14.6	14.6	6
SC11208	7/16"	49.0	15.9	15.9	6
SC11209	1/2"	49.0	17.6	17.6	6

1/4" Drive Quick-Release Round Head Ratchet

- Quick release design allows rapid socket removal
- 60-tooth design requires as little as 6° of swing arc to move a fastener
- Bright, full polish chrome finish easily wipes clean and resists corrosion
- Chrome vanadium alloy steel (Cr-V) for exceptional strength and durability
- Meets or exceeds ASME B107.110



Article Code	Length (mm)	
ST11901SC	142.0	4

1/4" Drive Quick-Release Teardrop Ratchet

- Quick release design allows rapid socket removal
- 60-tooth design requires as little as 6° of swing arc to move a fastener
- Flush mounted reversing lever allows user to change direction with one hand without removing the ratchet
- Teardrop, low-profile head and flush-mounted on/off switch allow better access in tight spaces
- Bright, full polish chrome finish easily wipes clean and resists corrosion
- Chrome vanadium alloy steel (Cr-V) for exceptional strength and durability
- Meets or exceeds ASME B107.110



Article Code	Length (mm)	
ST11905ST	143.0	4



Article Code	Length (mm)	
ST11906ST	143.0	4

1/4" Drive Heavy Duty Offset Quick-Release Teardrop Ratchet

- Quick release design allows rapid socket removal
- 45-tooth design requires as little as 8° of swing arc to move a fastener
- Offset handle design provides knuckle clearance in tight access application
- Bright, full polish chrome finish easily wipes clean and resists corrosion
- Chrome vanadium alloy steel (Cr-V) for exceptional strength and durability
- Meets or exceeds ASME B107.110



Article Code	Length (mm)	
ST11970SC	153.0	4

1/4" Drive 120XP Ratchet

- Designed with 120 positions providing a 3° swing arc so you can turn fasteners in tighter confines
- Designed with two double stacked 60-tooth pawls for exceptional strength
- Enclosed ratchet head design resists dirt infiltration for continuous and efficient execution
- Up to 50% thinner than conventional ratchet systems
- Teardrop, low-profile head and flush-mounted on/off switch allow better access in tight spaces
- Flush mounted reversing lever allows user to change direction with one hand without removing the wrench
- Bright, full polish chrome finish easily wipes clean and resists corrosion
- Chrome vanadium alloy steel (Cr-V) for exceptional strength and durability
- Meets or exceeds ASME B107.110



Article Code	Length (mm)	
ST11974	143.0	10

1/4" Drive Flex Handle / Breaker Bar

- Handle for more leverage to break stubborn fasteners free
- Flex head drive for multiple angles of use
- One-Piece alloy steel construction for rugged performance
- Ball detent helps to secure the socket to the drive tang
- Bright, full polish chrome finish easily wipes clean and resists corrosion
- Chrome vanadium alloy steel (Cr-V) for exceptional strength and durability
- Meets or exceeds ASME B107.110



Article Code	Length (mm)	
ST11909SC	140.0	6

1/4" Drive T-Handle

- Sliding T-Handle provides more leverage to break free stubborn fasteners
- Ball detent for secure socket retention
- Allows for use with one hand on each side of drive tang
- Bright, full polish chrome finish easily wipes clean and resists corrosion
- Chrome vanadium alloy steel (Cr-V) for exceptional strength and durability
- Meets or exceeds ASME B107.110



Article Code	Length (mm)	
ST11910SC	100.0	6

1/4" Drive Spinner Handle

- Ergonomic handle provides the optimal balance of strength and efficiency
- Ball detent for secure socket retention
- High impact composite handle
- Chrome vanadium alloy steel (Cr-V) for exceptional strength and durability
- Meets or exceeds ASME B107.110



Article Code	Length (mm)	
ST11911SC	150.0	6

1/4" Drive Universal Joint

- Universal joint for better access to hard-to-reach fasteners
- Pin hole can be used with detent pin for secure socket retention to the adapter
- Bright, full polish chrome finish easily wipes clean and resists corrosion
- Chrome vanadium alloy steel (Cr-V) for exceptional strength and durability
- Meets or exceeds ASME B107.110

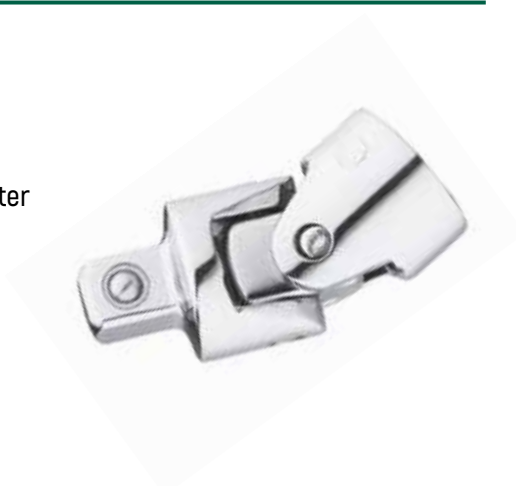

 These sockets accessories should never be used on power drivers, pneumatic impact wrench and/or extenders.

Article Code	Length (mm)	
ST11912SC	34.7	6

1/4" Drive Adapter 3/8"

- Pin hole can be used with detent pin for secure socket retention to the adapter
- Bright, full polish chrome finish easily wipes clean and resists corrosion
- Chrome vanadium alloy steel (Cr-V) for exceptional strength and durability
- Meets or exceeds ASME B107.110



 These sockets accessories should never be used on power drivers, pneumatic impact wrench and/or extenders.

Article Code	Length (mm)	
ST11913SC	25.5	6

1/4" Drive Bit Adapter

- Precise fit for bit in adapter
- Bright, full polish chrome finish easily wipes clean and resists corrosion
- Chrome vanadium alloy steel (Cr-V) for exceptional strength and durability
- Meets or exceeds ASME B107.110



⚠ These sockets accessories should never be used on power drivers, pneumatic impact wrench and/or extenders.

Article Code	
ST11914SC	12

1/4" Drive Flex Extension

- Flex shaft allows extension to bend into multiple positions
- Reach difficult to access fasteners standard sockets/extensions cannot reach
- Makes it possible to move at an angle up to 20°
- Designed to access extreme angled fasteners, for use in low torque applications
- Pin hole can be used with detent pin for secure socket retention to the extension
- Chrome vanadium alloy steel (Cr-V) for exceptional strength and durability
- Meets or exceeds ASME B107.110

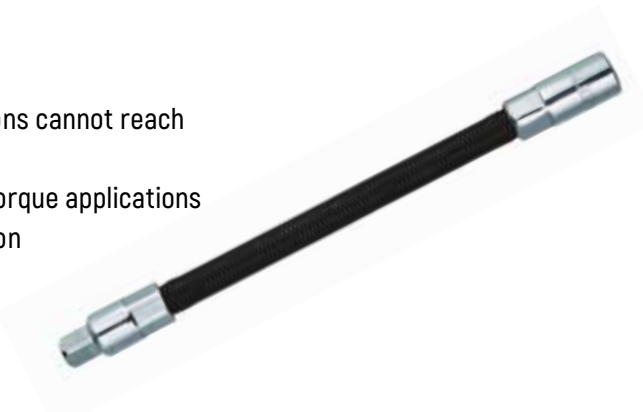

⚠ These sockets accessories should never be used on power drivers, pneumatic impact wrench and/or extenders.

Article Code	Length (mm)	
ST11922SC	150.0	6

1/4" Drive Wobble Extensions

- Wobble extension for better reach to more fasteners
- Provides better angled access vs standard non-wobble extension bars
- Knurled grip provides a nonslip surface
- Ball detent for secure socket retention
- Bright, full polish chrome finish easily wipes clean and resists corrosion
- Chrome vanadium alloy steel (Cr-V) for exceptional strength and durability
- Meets or exceeds ASME B107.110



⚠ These sockets accessories should never be used on power drivers, pneumatic impact wrench and/or extenders.

Article Code	Size	Length (mm)	
ST11903SC	2"	50.8	6
ST11904SC	4"	101.6	6

1/4" Drive Bit Sockets

- Precision engineered bits for a better fit on fasteners
- Large stamped size markings provide quick size identification
- Heat treated for long lasting durability
- Bright, full polish chrome finish easily wipes clean and resists corrosion
- S2 steel insert bits offer maximum strength and durability
- Meets or exceeds ASME B107.110

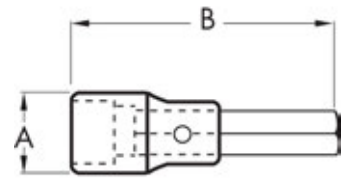

Article Code	Fastener Size	Length (mm) (Dimension B)	Drive End (mm) (Dimension A)	
SC21301	Phillips #1	36.5	12.0	12
SC21302	Phillips #2	36.5	12.0	12
SC21303	Phillips #3	36.5	12.0	12

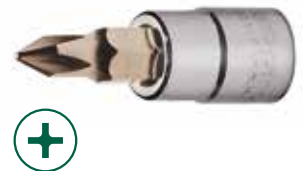

Article Code	Fastener Size	Length (mm) (Dimension B)	Drive End (mm) (Dimension A)	
SC21401	Pozidriv #1	36.5	12.0	12
SC21402	Pozidriv #2	36.5	12.0	12
SC21403	Pozidriv #3	36.5	12.0	12



Article Code	Fastener Size	Length (mm) (Dimension B)	Drive End (mm) (Dimension A)	
SC21501	Slotted 4.0 mm	36.5	12.0	12
SC21502	Slotted 5.5 mm	36.5	12.0	12
SC21503	Slotted 6.5 mm	36.5	12.0	12



Article Code	Fastener Size	Length (mm) (Dimension B)	Drive End (mm) (Dimension A)	
SC21201	Hex 3.0 mm	36.5	12.0	12
SC21202	Hex 4.0 mm	36.5	12.0	12
SC21203	Hex 5.0 mm	36.5	12.0	12
SC21204	Hex 6.0 mm	36.5	12.0	12
SC21206	Hex 7.0 mm	36.5	12.0	12
SC21205	Hex 8.0 mm	36.5	12.0	12



Article Code	Fastener Size	Length (mm) (Dimension B)	Drive End (mm) (Dimension A)	
SC21101	Torx® T8	36.5	12.0	12
SC21102	Torx® T10	36.5	12.0	12
SC21103	Torx® T15	36.5	12.0	12
ST21104SC	Torx® T20	36.5	12.0	12
ST21105SC	Torx® T25	36.5	12.0	12
ST21108BU	Torx® T27	36.5	12.0	12
ST21106	Torx® T30	36.5	12.0	12
SC21107	Torx® T40	36.5	12.0	12



These sockets accessories should never be used on power drivers, pneumatic impact wrench and/or extenders.

5 Pc. 3/8" Drive Metric Spark Plug Socket Set

Article Code	Content	
ST09003SJ	1 - Wobble Extension Bar 6" 1 - Locking Extension Bar 6" 1 - Offset Flex Head Ratchet Handle 2 - Spark Plug Sockets 16, 21 mm	12



14 Pc. 3/8" Drive 6 Point Metric Socket Set

Article Code	Content	
ST09523	1 - Quick-Release Round Head Ratchet 12 - 6pt. Metric Sockets 8, 9, 10, 11, 12, 13, 14, 15, 16, 17, 18, 19 mm	12



22 Pc. 3/8" Drive 6 Point Metric Socket Set

Article Code	Content	
ST09524	1 - Quick-Release Ratchet 14 - 6pt. Metric Sockets 6, 7, 8, 9, 10, 11, 12, 13, 14, 15, 16, 17, 18, 19 mm 4 - 6pt. Metric Deep Sockets 12, 13, 17, 19 mm 1 - Spark Plug Socket 16 mm 1 - Extension Bar 6"	10



60 Pc. 3/8" Drive 6 Point Metric Socket Set

Article Code	Content	
ST09004SJ	1 - Quick-Release Ratchet 18 - 6pt. Metric Sockets 6, 7, 8, 9, 10, 11, 12, 13, 14, 15, 16, 17, 18, 19, 20, 21, 22, 24 mm 11 - 6pt. Metric Deep Sockets 8, 10, 11, 12, 13, 14, 15, 16, 17, 18, 19 mm 2 - Spark Plug Sockets 16, 21 mm 24 - Bit Sockets Slotted 5.5, 6.5, 8 mm Phillips #1 (2x), #2 (2x), #3 Torx® T10, T15, T20, T25, T30, T40, T45, T50, T55 Hex 3, 4, 5, 6, 7, 8, 10 mm 4 - Accessories Wobble Extension Bars 3", 10" Universal Joint 1/2" F x 3/8" M 3-Way Adapter	3



16 Pc. 3/8" Drive 6 Point SAE Socket Set

Article Code	Content	
ST09085SJ	1 - Quick-Release Ratchet 11 - 6pt. SAE Sockets 1/4, 5/16, 3/8, 7/16, 1/2, 9/16, 5/8, 11/16, 3/4, 13/16, 7/8" 4 - Accessories Wobble Extensions 3", 6" Flex Handle 8" 1/2" F x 3/8" M 3-Way Adapter	12



3/8" Drive 6 Point Socket

- Single hex (6 pt.) fastener end design
- Off-corner loading design reduces fastener rounding
- Large markings offer easy size identification
- Double line (SAE) & knurled line (MM) to easily identify standard and metric sockets
- Manufactured to industrial specifications assuring a thin wall design with precise nut end dimensions
- Heat treated for long lasting durability
- Bright, full polish chrome finish easily wipes clean and resists corrosion
- Chrome vanadium alloy steel (Cr-V) for exceptional strength and durability
- Meets or exceeds ASME B107.110

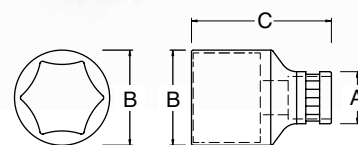

Article Code	Fastener Size	Overall Length (mm) (Dimension C)	Drive End (mm) (Dimension A)	Wrench End (mm) (Dimension B)	
ST12301SC	6.0 mm	25.0	17.0	10.0	6
ST12302SC	7.0 mm	25.0	17.0	10.8	6
ST12303SC	8.0 mm	25.0	17.0	11.9	6
ST12304SC	9.0 mm	25.0	17.0	12.9	6
ST12305SC	10.0 mm	25.0	17.0	14.5	6
ST12306SC	11.0 mm	25.0	17.0	15.8	6
ST12307SC	12.0 mm	25.0	17.0	17.0	6
ST12308SC	13.0 mm	25.0	18.3	18.3	6
ST12309SC	14.0 mm	25.0	19.5	19.5	6
ST12310SC	15.0 mm	25.0	20.8	20.8	6
ST12311SC	16.0 mm	25.0	22.0	22.0	6
ST12312SC	17.0 mm	25.0	23.3	23.3	6
ST12313SC	18.0 mm	25.0	23.8	23.8	6
ST12314SC	19.0 mm	28.0	25.5	19.0	6
ST12315SC	20.0 mm	28.0	27.0	23.0	4
ST12316SC	21.0 mm	28.0	27.5	25.0	4
ST12317SC	22.0 mm	31.5	29.5	26.0	4
ST12318SC	24.0 mm	31.5	31.9	26.0	4
ST12101SC	1/4"	25.0	17.2	10.9	6
ST12102SC	5/16"	25.0	17.2	11.9	6
ST12103SC	3/8"	25.0	17.2	13.8	6
ST12104SC	7/16"	25.0	17.2	16.0	6
ST12105SC	1/2"	25.0	17.9	17.9	6
ST12106SC	9/16"	25.0	19.7	19.7	6
ST12107SC	5/8"	25.0	22.2	22.2	6
ST12108SC	11/16"	25.0	23.9	23.9	6
ST12109SC	3/4"	25.0	25.6	25.6	6
ST12110SC	13/16"	28.0	27.9	27.9	6
SC12111	7/8"	28.0	29.7	29.7	6



These sockets accessories should never be used on power drivers, pneumatic impact wrench and/or extenders.

3/8" Drive 12 Point Socket

- Double hex (12 pt.) fastener end design
- Off-corner loading design reduces fastener rounding
- Large markings offer easy size identification
- Double line (SAE) & knurled line (MM) to easily identify standard and metric sockets
- Manufactured to industrial specifications assuring a thin wall design with precise nut end dimensions
- Heat treated for long lasting durability
- Bright, full polish chrome finish easily wipes clean and resists corrosion
- Chrome vanadium alloy steel (Cr-V) for exceptional strength and durability
- Meets or exceeds ASME B107.110

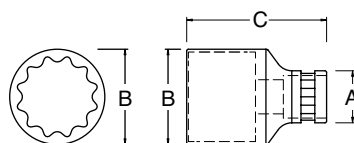

⚠ These sockets accessories should never be used on power drivers, pneumatic impact wrench and/or extenders.

Article Code	Fastener Size	Overall Length (mm) (Dimension C)	Drive End (mm) (Dimension A)	Wrench End (mm) (Dimension B)	
ST12601BU	8.0 mm	25.0	17.0	11.9	6
ST12602BU	9.0 mm	25.0	17.0	12.9	6
ST12603BU	10.0 mm	25.0	17.0	14.5	6
ST12604BU	11.0 mm	25.0	17.0	15.8	6
ST12605BU	12.0 mm	25.0	17.0	17.0	6
ST12606BU	13.0 mm	25.0	18.3	18.3	6
ST12607BU	14.0 mm	25.0	19.5	19.5	6
ST12608BU	15.0 mm	25.0	20.8	20.8	6
ST12609BU	16.0 mm	25.0	22.0	22.0	6
ST12610BU	17.0 mm	25.0	23.3	23.3	6
ST12611BU	18.0 mm	25.0	23.8	23.8	6
ST12612BU	19.0 mm	28.0	25.5	19.0	6
ST12613BU	20.0 mm	28.0	27.0	23.0	4
ST12614BU	21.0 mm	28.0	27.5	25.0	4
ST12615BU	22.0 mm	31.5	29.5	26.0	4
ST12616BU	24.0 mm	31.5	31.9	26.0	4

3/8" Drive 6 Point Deep Socket

- Single hex (6 pt.) fastener end design
- Off-corner loading design reduces fastener rounding
- Deep socket to reach more fasteners
- Large markings offer easy size identification
- Double line (SAE) & knurled line (MM) to easily identify standard and metric sockets
- Manufactured to industrial specifications assuring a thin wall design with precise nut end dimensions
- Heat treated for long lasting durability
- Bright, full polish chrome finish easily wipes clean and resists corrosion
- Chrome vanadium alloy steel (Cr-V) for exceptional strength and durability
- Meets or exceeds ASME B107.110

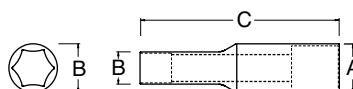

⚠ These sockets accessories should never be used on power drivers, pneumatic impact wrench and/or extenders.

Article Code	Fastener Size	Overall Length (mm) (Dimension C)	Drive End (mm) (Dimension A)	Wrench End (mm) (Dimension B)	
ST12401SC	8.0 mm	63.5	16.8	11.9	6
ST12402SC	9.0 mm	63.5	16.8	12.9	6
ST12403SC	10.0 mm	63.5	16.8	14.5	6
ST12404SC	11.0 mm	63.5	16.8	15.8	6
ST12405SC	12.0 mm	63.5	16.8	16.8	6
ST12406SC	13.0 mm	63.5	18.7	18.7	6
ST12407SC	14.0 mm	63.5	19.5	19.5	6
ST12408SC	15.0 mm	63.5	20.8	20.8	6
ST12409SC	16.0 mm	63.5	22.0	22.0	6
ST12410SC	17.0 mm	63.5	23.7	23.7	6
ST12411SC	18.0 mm	63.5	23.8	23.8	6
ST12412SC	19.0 mm	63.5	25.5	25.5	6
ST12413SC	20.0 mm	63.5	27.0	27.0	4
ST12414SC	21.0 mm	63.5	27.8	27.8	4
ST12415SC	22.0 mm	63.5	29.5	29.5	4
SC12201	3/8"	63.5	16.8	13.8	6
SC12202	7/16"	63.5	16.8	16.0	6
SC12203	1/2"	63.5	18.3	18.3	6
SC12204	9/16"	63.5	19.8	19.8	6
SC12205	5/8"	63.5	22.0	22.0	6
SC12206	11/16"	63.5	23.8	23.8	6
SC12207	3/4"	63.5	25.6	25.6	6
SC12208	13/16"	63.5	27.8	27.8	6
SC12209	7/8"	63.5	29.8	29.8	6

3/8" Drive External Torx® Sockets

- Off-corner loading design reduces fastener rounding
- Large markings offer easy size identification
- Manufactured to industrial specifications assuring a thin wall design with precise nut end dimensions
- Heat treated for long lasting durability
- Bright, full polish chrome finish easily wipes clean and resists corrosion
- Chrome vanadium alloy steel (Cr-V) for exceptional strength and durability
- Meets or exceeds Camcar TXF-701

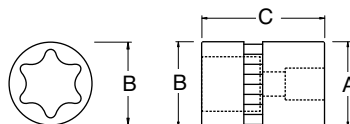

⚠ These sockets accessories should never be used on power drivers, pneumatic impact wrench and/or extenders.

Article Code	Fastener Size	Overall Length (mm) (Dimension C)	Drive End (mm) (Dimension A)	Wrench End (mm) (Dimension B)	
ST12701SC	E4	26.0	17.0	7.0	6
ST12702SC	E5	26.0	17.0	8.0	6
ST12703SC	E6	26.0	17.0	8.0	6
ST12704SC	E7	26.0	17.0	9.0	6
ST12705SC	E8	26.0	17.0	10.5	6
ST12706SC	E10	26.0	17.0	13.0	6
ST12707SC	E11	26.0	17.0	14.0	6
ST12708SC	E12	26.0	17.0	15.0	6
ST12709SC	E14	28.5	18.3	18.3	6
ST12710SC	E16	28.5	18.3	18.3	6
ST12711SC	E18	28.5	19.5	19.5	6
ST12712SC	E20	30.5	22.0	22.0	6

3/8" Drive Spark Plug Socket

- Single hex (6 pt.) fastener end design
- Off-corner loading design reduces fastener rounding
- Large markings offer easy size identification
- Manufactured to industrial specifications assuring a thin wall design with precise nut end dimensions
- Heat treated for long lasting durability
- Bright, full polish chrome finish easily wipes clean and resists corrosion
- Chrome vanadium alloy steel (Cr-V) for exceptional strength and durability
- Meets or exceeds ASME B107.110



⚠ These sockets accessories should never be used on power drivers, pneumatic impact wrench and/or extenders.

Article Code	Fastener Size	
ST12915SC	16.0 mm	6
ST12916SC	21.0 mm	6
ST12919SC	5/8"	6
ST12920SC	13/16"	6

3/8" Drive Quick-Release Stubby Ratchet

- Stubby handle length for improved access
- Quick release design allows rapid socket removal
- Flush mounted reversing lever allows user to change direction with one hand without removing the wrench
- Teardrop, low-profile head and flush-mounted on/off switch allow better access in tight spaces
- Bright, full polish chrome finish easily wipes clean and resists corrosion
- Chrome vanadium alloy steel (Cr-V) for exceptional strength and durability
- Meets or exceeds ASME B107.110



Article Code	Length (mm)	
ST12960SC	169.0	6

3/8" Drive Quick-Release Round Head Ratchet

- Quick release design allows rapid socket removal
- 60-tooth design requires as little as 6° of swing arc to move a fastener
- Bright, full polish chrome finish easily wipes clean and resists corrosion
- Chrome vanadium alloy steel (Cr-V) for exceptional strength and durability
- Meets or exceeds ASME B107.110



Article Code	Length (mm)	
ST12901SC	197.0	4

3/8" Drive Quick-Release Teardrop Ratchet

- Quick release design allows rapid socket removal
- 60-tooth design requires as little as 6° of swing arc to move a fastener
- Flush mounted reversing lever allows user to change direction with one hand without removing the wrench
- Teardrop, low-profile head and flush-mounted on/off switch allow better access in tight spaces
- Bright, full polish chrome finish easily wipes clean and resists corrosion
- Chrome vanadium alloy steel (Cr-V) for exceptional strength and durability
- Meets or exceeds ASME B107.110



Article Code	Length (mm)	
ST12971ST	200.0	4

3/8" Drive Quick-Release Teardrop Ratchet

- Quick release design allows rapid socket removal
- 60-tooth design requires as little as 6° of swing arc to move a fastener
- Flush mounted reversing lever allows user to change direction with one hand without removing the wrench
- Teardrop, low-profile head and flush-mounted on/off switch allow better access in tight spaces
- Bright, full polish chrome finish easily wipes clean and resists corrosion
- Chrome vanadium alloy steel (Cr-V) for exceptional strength and durability
- Meets or exceeds ASME B107.110



Article Code	Length (mm)	
ST12972ST	200.0	4

3/8" Drive Offset Flex Quick-Release Teardrop Ratchet

- Quick release design allows rapid socket removal
- 45-tooth design requires as little as 8° of swing arc to move a fastener
- Flush mounted reversing lever allows user to change direction with one hand without removing the wrench
- Flex head provides access for hard to reach angeled fasteners
- Teardrop, low-profile head and flush-mounted on/off switch allow better access in tight spaces
- Bright, full polish chrome finish easily wipes clean and resists corrosion
- Chrome vanadium alloy steel (Cr-V) for exceptional strength and durability
- Meets or exceeds ASME B107.110



Article Code	Length (mm)	
ST12911SC	275.0	4

3/8" Drive Heavy Duty Offset Quick-Release Teardrop Ratchet

- Quick release design allows rapid socket removal
- 60-tooth design requires as little as 6° of swing arc to move a fastener
- Flush mounted reversing lever allows user to change direction with one hand without removing the wrench
- Teardrop, low-profile head and flush-mounted on/off switch allow better access in tight spaces
- Bright, full polish chrome finish easily wipes clean and resists corrosion
- Chrome vanadium alloy steel (Cr-V) for exceptional strength and durability
- Meets or exceeds ASME B107.110



Article Code	Length (mm)	
ST12970SC	217.0	4

3/8" Drive 120XP Ratchet

- Designed with 120 positions providing a 3° swing arc so you can turn fasteners in tighter confines
- Designed with two double stacked 60-tooth pawls for exceptional strength
- Enclosed ratchet head design resists dirt infiltration for continuous and efficient execution
- Up to 50% thinner than conventional ratchet systems
- Teardrop, low-profile head and flush-mounted on/off switch allow better access in tight spaces
- Flush mounted reversing lever allows user to change direction with one hand without removing the wrench
- Bright, full polish chrome finish easily wipes clean and resists corrosion
- Chrome vanadium alloy steel (Cr-V) for exceptional strength and durability
- Meets or exceeds ASME B107.110



Article Code	Length (mm)	
ST12974	200.0	10

3/8" Drive Flex Handle / Breaker Bar

- Handle for more leverage to break stubborn fasteners free
- Flex head drive for multiple angles of use
- One-Piece alloy steel construction for rugged performance
- Ball detent helps to secure the socket to the drive tang
- Bright, full polish chrome finish easily wipes clean and resists corrosion
- Chrome vanadium alloy steel (Cr-V) for exceptional strength and durability
- Meets or exceeds ASME B107.110



Article Code	Length (mm)	
ST12909SC	213.0	6

3/8" Drive T-Handle

- Sliding T-Handle provides more leverage to break free stubborn fasteners
- Ball detent for secure socket retention
- Allows for use with one hand on each side of drive tang
- Bright, full polish chrome finish easily wipes clean and resists corrosion
- Chrome vanadium alloy steel (Cr-V) for exceptional strength and durability
- Meets or exceeds ASME B107.110





Article Code	Length (mm)	
ST12910SC	247.0	6

3/8" Drive Universal Joint

- Universal joint for better access to hard-to-reach fasteners
- Pin hole can be used with detent pin for secure socket retention to the adapter
- Bright, full polish chrome finish easily wipes clean and resists corrosion
- Chrome vanadium alloy steel (Cr-V) for exceptional strength and durability
- Meets or exceeds ASME B107.110



 These sockets accessories should never be used on power drivers, pneumatic impact wrench and/or extenders.

Article Code	Length (mm)	
ST12912SC	51.2	6

3/8" Drive Adapter

- Pin hole can be used with detent pin for secure socket retention to the adapter
- Bright, full polish chrome finish easily wipes clean and resists corrosion
- Chrome vanadium alloy steel (Cr-V) for exceptional strength and durability
- Meets or exceeds ASME B107.110



 These sockets accessories should never be used on power drivers, pneumatic impact wrench and/or extenders.

Article Code	Size	Length (mm)	
ST12913SC	1/4"	25.6	6
ST12914SC	1/2"	25.7	6

3/8" Drive Bit Adapter 1/4"

- Precise fit for bit in adapter
- Bright, full polish chrome finish easily wipes clean and resists corrosion
- Chrome vanadium alloy steel (Cr-V) for exceptional strength and durability
- Meets or exceeds ASME B107.110



 These sockets accessories should never be used on power drivers, pneumatic impact wrench and/or extenders.

Article Code	
ST12917SC	6

3/8" Drive 3-Way Adapter 1/2"

- 3 Position adapter
- Pin hole can be used with detent pin for secure socket retention to the adapter
- Bright, full polish chrome finish easily wipes clean and resists corrosion
- Chrome vanadium alloy steel (Cr-V) for exceptional strength and durability
- Meets or exceeds ASME B107.110



 These sockets accessories should never be used on power drivers, pneumatic impact wrench and/or extenders.

Article Code	
ST12930SC	6

3/8" Drive Flex Extension

- Flex shaft allows extension to bend into multiple positions
- Reach difficult to access fasteners standard sockets/extensions cannot reach
- Makes it possible to move at an angle up to 20°
- Designed to access extreme angled fasteners, for use in low torque applications
- Pin hole can be used with detent pin for secure socket retention to the extension
- Chrome vanadium alloy steel (Cr-V) for exceptional strength and durability
- Meets or exceeds ASME B107.110



 These sockets accessories should never be used on power drivers, pneumatic impact wrench and/or extenders.

Article Code	Length (mm)	
ST12922SC	200.0	6

3/8" Drive Wobble Extensions

- Wobble extension for better reach to more fasteners
- Provides better angled access versus standard non-wobble extension bars
- Knurled grip provides a nonslip surface
- Ball detent for secure socket retention
- Bright, full polish chrome finish easily wipes clean and resists corrosion
- Meets or exceeds ASME B107.110



 These sockets accessories should never be used on power drivers, pneumatic impact wrench and/or extenders.

Article Code	Size	Length (mm)	
ST12903SC	3"	76.2	6
ST12904SC	6"	152.4	6
ST12905SC	10"	254.0	6

3/8" Drive Locking Extension

- Locking extension for better reach to more fasteners
- Bright, full polish chrome finish easily wipes clean and resists corrosion
- Chrome vanadium alloy steel (Cr-V) for exceptional strength and durability
- Locking mechanism securely attaches socket to extension
- Knurled grip provides a nonslip surface
- Ball detent for secure socket retention
- Meets or exceeds ASME B107.110





 These sockets accessories should never be used on power drivers, pneumatic impact wrench and/or extenders.

Article Code	Size	Length (mm)	
ST12906SC	3"	76.2	6
ST12907SC	6"	152.4	6
ST12908SC	10"	254.0	6

3/8" Drive Bit Sockets

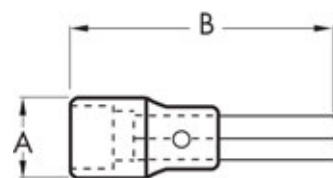
- Precision engineered bits for a better fit on fasteners
- Large stamped size markings provide quick size identification
- Heat treated for long lasting durability
- Bright, full polish chrome finish easily wipes clean and resists corrosion
- S2 steel insert bits offer maximum strength and durability
- Meets or exceeds ASME B107.110



Article Code	Fastener Size	Length (mm) (Dimension B)	Drive End (mm) (Dimension A)	
SC22301	Phillips #1	48.0	18.0	6
SC22302	Phillips #2	48.0	18.0	6
SC22303	Phillips #3	254	18.0	6

Article Code	Fastener Size	Length (mm) (Dimension B)	Drive End (mm) (Dimension A)	
SC22401	Pozidriv #1	48.0	18.0	6
SC22402	Pozidriv #2	48.0	18.0	6
SC22403	Pozidriv #3	254	18.0	6

Article Code	Fastener Size	Length (mm) (Dimension B)	Drive End (mm) (Dimension A)	
SC22504	Slotted 4.0 mm	48.0	18.0	6
SC22501	Slotted 5.5 mm	48.0	18.0	6
SC22502	Slotted 6.5 mm	48.0	18.0	6
SC22503	Slotted 8.0 mm	48.0	18.0	6

Article Code	Fastener Size	Length (mm) (Dimension B)	Drive End (mm) (Dimension A)	
SC22201	Hex 3.0 mm	48.0	18.0	6
SC22202	Hex 4.0 mm	48.0	18.0	6
SC22203	Hex 5.0 mm	48.0	18.0	6
SC22204	Hex 6.0 mm	48.0	18.0	6
SC22205	Hex 7.0 mm	48.0	18.0	6
SC22206	Hex 8.0 mm	48.0	18.0	6
SC22207	Hex 10.0 mm	48.0	18.0	6

Article Code	Fastener Size	Length (mm) (Dimension B)	Drive End (mm) (Dimension A)	
SC22101	Torx® T10	48.0	18.0	6
SC22102	Torx® T15	48.0	18.0	6
SC22103	Torx® T20	48.0	18.0	6
SC22104	Torx® T25	48.0	18.0	6
SC22105	Torx® T27	48.0	18.0	6
SC22106	Torx® T30	48.0	18.0	6
SC22107	Torx® T40	48.0	18.0	6
SC22108	Torx® T45	48.0	18.0	6
SC22109	Torx® T50	48.0	18.0	6
SC22110	Torx® T55	48.0	18.0	6
SC22111	Torx® T60	48.0	18.0	6

Article Code	Fastener Size	Length (mm) (Dimension B)	Drive End (mm) (Dimension A)	
SC22601	Tamper-Proof Torx® T45	48.0	18.0	6
SC22602	Tamper-Proof Torx® T50	48.0	18.0	6
SC22603	Tamper-Proof Torx® T55	48.0	18.0	6
SC22604	Tamper-Proof Torx® T60	48.0	18.0	6



 These sockets accessories should never be used on power drivers, pneumatic impact wrench and/or extenders.

16 Pc. 1/2" Drive 6 Point Metric Socket Set

Article Code	Content	
ST09520	10 - 6pt. Metric Sockets 8, 10, 12, 13, 14, 17, 19, 21, 22, 24 mm 6 - 6pt. Metric Deep Sockets 10, 12, 14, 17, 19, 21 mm	8



15 Pc. 1/2" Drive 6 Point Metric Socket Set

Article Code	Content	
ST09525SJ	1 - Quick-Release Round Head Ratchet 13 - 6pt. Metric Sockets 10, 12, 13, 14, 15, 16, 17, 18, 19, 20, 21, 22, 24 mm 1 - Wobble Extension Bar 5"	2



17 Pc. 1/2" Drive 12 Point Metric Socket Set

Article Code	Content	
ST09086SJ	1 - Quick-Release Ratchet 13 - 12pt. Metric Sockets 10, 11, 12, 13, 14, 15, 16, 17, 18, 19, 21, 22, 24 mm 1 - Spark Plug Socket 16 mm 2 - Accessories Wobble Extension 5" Flex Handle 10"	6



18 Pc. 1/2" Drive 12 Point Metric Socket Set

Article Code	Content	
ST09203SJ	1 - Quick-Release Ratchet 14 - 12pt. Metric Sockets 10, 11, 12, 13, 14, 15, 16, 17, 19, 21, 24, 27, 30, 32 mm 3 - Accessories Wobble Extensions 5", 10" T-Handle	6



18 Pc. 1/2" Drive 12 Point Metric Socket Set

Article Code	Content	
ST09204SJ	1 - Quick-Release Ratchet 14 - 12pt. Metric Sockets 10, 11, 12, 13, 14, 15, 16, 17, 19, 21, 24, 27, 30, 32 mm 3 - Accessories Wobble Extensions 5", 10" T-Handle	6



23 Pc. 1/2" Drive 6 Point Metric Socket Set

Article Code	Content	
ST09005SJ	1 - Quick-Release Ratchet 16 - 6pt. Metric Sockets 10, 11, 12, 13, 14, 15, 16, 17, 18, 19, 22, 24, 27, 30, 32, 34 mm 3 - 6pt. Metric Deep Sockets 13, 17, 19 mm 3 - Accessories Wobble Extension Bar 10" Universal Joint 1/2"Fx3/8"M 3-Way Adapter	4



23 Pc. 1/2" Drive 6 Point Metric Socket Set

Article Code	Content	
ST09526	1 - Quick-Release Round Head Ratchet 15 - 6pt. Metric Sockets 10, 12, 13, 14, 15, 16, 17, 18, 19, 22, 24, 27, 30, 32, 34 mm 4 - 6pt. Metric Deep Sockets 12, 14, 17, 19 mm 2 - Spark Plug Sockets 16, 21 mm 1 - Extension Bar 10"	4



24 Pc. 1/2" Drive 6 Point Metric Socket Set

Article Code	Content	
ST09060-6SJ	1 - Quick-Release Ratchet 19 - 6pt. Metric Sockets 9, 10, 11, 12, 13, 14, 15, 16, 17, 18, 19, 20, 21, 22, 23, 24, 27, 30, 32 mm 4 - Accessories Wobble Extension 5", 10" Univeresal Joint T-Handle	4



24 Pc. 1/2" Drive 12 Point Metric Socket Set

Article Code	Content	
ST09060SJ	1 - Quick-Release Ratchet 19 - 12pt. Metric Sockets 9, 10, 11, 12, 13, 14, 15, 16, 17, 18, 19, 20, 21, 22, 23, 24, 27, 30, 32 mm 4 - Accessories Wobble Extension Bars 5", 10" Universal Joint T-Handle	4



25 Pc. 1/2" Drive 12 Point Metric Socket Set

Article Code	Content	
ST09092ME-12	1 - Quick-Release Ratchet 20 - 12pt. Metric Sockets 8, 9, 10, 11, 12, 13, 14, 15, 16, 17, 18, 19, 20, 21, 22, 23, 24, 27, 30, 32 mm 1 - Spark Plug Socket 21 mm 3 - Accessories Wobble Extension 10" Universal Joint Flex handle	4



28 Pc. 1/2" Drive 12 Point Metric Socket Set

Article Code	Content	
ST09090SJ	1 - Quick-Release Ratchet 21 - 12pt. Metric Sockets 10, 11, 12, 13, 14, 15, 16, 17, 18, 19, 20, 21, 22, 23, 24, 25, 26, 27, 28, 30, 32 mm 6 - Accessories Wobble Extensions 5", 10" Flex Handle 10" T-Handle Universal Joint Speed Handle	4



60 Pc. 1/2" Drive 6 Point Metric Socket Set

Article Code	Content	
ST09007SJ	1 - Quick-Release Ratchet 17 - 6pt. Metric Sockets 10, 11, 12, 13, 14, 15, 16, 17, 18, 19, 20, 21, 22, 24, 27, 30, 32 mm 10 - 6pt. Metric Deep Sockets 10, 11, 12, 13, 14, 15, 16, 17, 18, 19 mm 18 - 1/4" Shank 25L Bits Pozidriv #1, #2, #3 Hex 2, 3, 4, 5, 6, 7, 8 Torx® T8, T10, T15, T20, T25, T27, T30, T40 6 - 1/4" Shank 25L Bits Slotted 4, 5.5, 6.5 mm Phillips #1, #2, #3 8 - Accessories Spark Plug Sockets 16, 21 mm Wobble Extension Bars 5", 10" Universal Joint 3/8"Fx1/2"M 3-Way Adapter 1/4" Bit Adapter 1/4" Dr. Socket Driver	3



20 Pc. 1/2" Drive 6 and 12 Point SAE Socket Set

Article Code	Content	
ST09087SJ	1 - Quick-Release Ratchet 8 - 6pt. SAE Sockets 5/16, 3/8, 7/16, 1/2, 9/16, 5/8, 11/16, 3/4" 7 - 12pt. SAE Sockets 13/16, 7/8, 15/16, 1, 1-1/16, 1-1/8, 1-1/4" 4 - Accessories Wobble Extensions 5", 10" Flex Handle 15" 3/8"Fx1/2"M 3-Way Adapter	4



22 Pc. 1/2" Drive 12 Point SAE Socket Set

Article Code	Content	
ST09088SJ	1- Quick-Release Ratchet 15 - 12pt. SAE Sockets 5/16", 3/8", 7/16", 1/2", 9/16", 5/8", 11/16", 3/4", 13/16", 7/8", 15/16", 1", 1-1/16", 1-1/8", 1-1/4" 6 - Accessories Wobble Extension Bars 5", 10" T-Handle Universal Joint Flex handle 10" Quick rocker	3



46 Pc. 1/2" Drive 6 Point Metric/SAE Socket Set

Article Code	Content	
ST09006SJ	1- Quick-Release Ratchet 20 - 6pt. Metric Sockets 8, 9, 10, 11, 12, 13, 14, 15, 16, 17, 18, 19, 20, 21, 22, 24, 27, 30, 32, 34 mm 7 - 6pt. Metric Deep Sockets 10, 12, 13, 14, 15, 17, 19 mm 11 - 6pt. SAE Sockets 3/8, 7/16, 1/2, 9/16, 5/8, 11/16, 3/4, 13/16, 7/8, 15/16, 1" 2 - Metric Spark Plug Sockets 16, 21 mm 5 - Accessories Flex Handle 10" Wobble Extensions 5", 10" Universal Joint 3/8" F x 1/2" M 3-Way Adapter	3



1/2" Drive 6 Point Socket

- Single hex (6 pt.) fastener end design
- Off-corner loading design reduces fastener rounding
- Large markings offer easy size identification
- Double line (SAE) & knurled line (MM) to easily identify standard and metric sockets
- Manufactured to industrial specifications assuring a thin wall design with precise nut end dimensions
- Heat treated for long lasting durability
- Bright, full polish chrome finish easily wipes clean and resists corrosion
- Chrome vanadium alloy steel (Cr-V) for exceptional strength and durability
- Meets or exceeds ASME B107.110

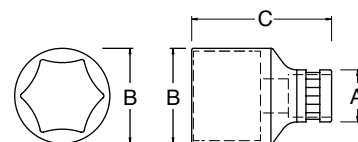

⚠ These sockets accessories should never be used on power drivers, pneumatic impact wrench and/or extenders.

Article Code	Fastener Size	Overall Length (mm) (Dimension C)	Drive End (mm) (Dimension A)	Wrench End (mm) (Dimension B)	
ST13319SC	8.0 mm	38.0	22.2	13.3	6
ST13320SC	9.0 mm	38.0	22.2	14.3	6
ST13301SC	10.0 mm	38.0	22.2	15.3	6
ST13302SC	11.0 mm	38.0	22.2	16.5	6
ST13303SC	12.0 mm	38.0	22.2	17.8	6
ST13304SC	13.0 mm	38.0	22.2	19.0	6
ST13305SC	14.0 mm	38.0	22.2	20.3	6
ST13306SC	15.0 mm	38.0	22.2	22.2	6
ST13307SC	16.0 mm	38.0	22.2	22.2	6
ST13308SC	17.0 mm	38.0	23.9	23.9	6
ST13309SC	18.0 mm	38.0	24.9	24.9	6
ST13310SC	19.0 mm	38.0	25.9	24.0	6
ST13311SC	20.0 mm	38.0	27.8	24.0	4
ST13312SC	21.0 mm	38.0	27.9	24.0	4
ST13313SC	22.0 mm	38.0	29.9	26.0	4
ST13314SC	23.0 mm	40.0	31.1	26.0	4
ST13315SC	24.0 mm	40.0	31.9	26.0	4
ST13316SC	27.0 mm	40.0	35.9	29.0	4
ST13324	28.0 mm	40.0	37.6	30.0	4
ST13317SC	30.0 mm	42.0	39.9	33.0	2
ST13318SC	32.0 mm	42.0	41.9	34.0	2
ST13321SC	34.0 mm	42.0	43.9	35.0	2
ST13101SC	5/16"	37.8	22.2	13.3	6
ST13102SC	3/8"	37.8	22.2	14.5	6
ST13103SC	7/16"	37.8	22.2	17.0	6
ST13104SC	1/2"	37.8	22.2	18.6	6
ST13105SC	9/16"	37.8	22.2	20.6	6
ST13106SC	5/8"	37.8	22.2	22.2	6
ST13107SC	11/16"	37.8	23.8	23.8	6
ST13108SC	3/4"	37.8	25.9	25.9	6
ST13109SC	13/16"	37.8	27.9	27.9	4
ST13110SC	7/8"	37.8	29.9	29.9	4
ST13111SC	15/16"	37.8	31.9	31.9	4
ST13112SC	1"	40.0	33.9	33.9	4
ST13113SC	1.1/16"	40.0	35.9	35.9	4
ST13114SC	1.1/8"	42.0	37.9	37.9	4
ST13115SC	1.1/4"	42.0	41.9	41.9	2

1/2" Drive 12 Point Socket

- Double hex (12 pt.) fastener end design
- Off-corner loading design reduces fastener rounding
- Large markings offer easy size identification
- Double line (SAE) & knurled line (MM) to easily identify standard and metric sockets
- Manufactured to industrial specifications assuring a thin wall design with precise nut end dimensions
- Heat treated for long lasting durability
- Bright, full polish chrome finish easily wipes clean and resists corrosion
- Chrome vanadium alloy steel (Cr-V) for exceptional strength and durability
- Meets or exceeds ASME B107.110

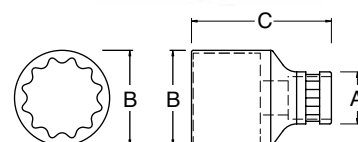

⚠ These sockets accessories should never be used on power drivers, pneumatic impact wrench and/or extenders.

Article Code	Fastener Size	Overall Length (mm) (Dimension C)	Drive End (mm) (Dimension A)	Wrench End (mm) (Dimension B)	
ST13619SC	8.0 mm	38.0	22.2	13.3	6
ST13620SC	9.0 mm	38.0	22.2	14.3	6
ST13601SC	10.0 mm	38.0	22.2	15.3	6
ST13602SC	11.0 mm	38.0	22.2	16.5	6
ST13603SC	12.0 mm	38.0	22.2	17.8	6
ST13604SC	13.0 mm	38.0	22.2	19.0	6
ST13605SC	14.0 mm	38.0	22.2	20.3	6
ST13606SC	15.0 mm	38.0	22.2	22.2	6
ST13607SC	16.0 mm	38.0	22.2	22.2	6
ST13608SC	17.0 mm	38.0	23.9	23.9	6
ST13609SC	18.0 mm	38.0	24.9	24.9	6
ST13610SC	19.0 mm	38.0	25.9	24.0	6
ST13611SC	20.0 mm	38.0	27.8	24.0	4
ST13612SC	21.0 mm	38.0	27.9	24.0	4
ST13613SC	22.0 mm	38.0	29.9	26.0	4
ST13614SC	23.0 mm	40.0	31.1	26.0	4
ST13615SC	24.0 mm	40.0	31.9	26.0	4
ST13616SC	27.0 mm	40.0	35.9	29.0	4
ST13617SC	30.0 mm	42.0	39.9	33.0	2
ST13618SC	32.0 mm	42.0	41.9	34.0	2
ST13501SC	5/16"	37.8	22.2	13.3	6
ST13502SC	3/8"	37.8	22.2	14.5	6
ST13503SC	7/16"	37.8	22.2	17.0	6
ST13504SC	1/2"	37.8	22.2	18.6	6
ST13505SC	9/16"	37.8	22.2	20.6	6
ST13506SC	5/8"	37.8	22.2	22.2	6
ST13507SC	11/16"	37.8	23.8	23.8	6
ST13508SC	3/4"	37.8	25.9	25.9	4
ST13509SC	13/16"	37.8	27.9	27.9	4
ST13510SC	7/8"	37.8	29.9	29.9	4
ST13511SC	15/16"	37.8	31.9	31.9	4
ST13512SC	1"	40.0	33.9	33.9	4
ST13513SC	1.1/16"	40.0	35.9	35.9	4
ST13514SC	1.1/8"	42.0	37.9	37.9	4
ST13515SC	1.1/4"	42.0	41.9	41.9	2

1/2" Drive 6 Point Deep Socket

- Single hex (6 pt.) fastener end design
- Off-corner loading design reduces fastener rounding
- Deep socket to reach more fasteners
- Large markings offer easy size identification
- Double line (SAE) & knurled line (MM) to easily identify standard and metric sockets
- Manufactured to industrial specifications assuring a thin wall design with precise nut end dimensions
- Heat treated for long lasting durability
- Bright, full polish chrome finish easily wipes clean and resists corrosion
- Chrome vanadium alloy steel (Cr-V) for exceptional strength and durability
- Meets or exceeds ASME B107.110

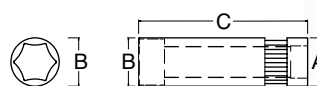

⚠ These sockets accessories should never be used on power drivers, pneumatic impact wrench and/or extenders.

Article Code	Fastener Size	Overall Length (mm) (Dimension C)	Drive End (mm) (Dimension A)	Wrench End (mm) (Dimension B)	
ST13401SC	10.0 mm	77.0	22.0	15.3	6
ST13402SC	11.0 mm	77.0	22.0	16.5	6
ST13403SC	12.0 mm	77.0	22.0	17.8	6
ST13404SC	13.0 mm	77.0	22.0	19.0	6
ST13405SC	14.0 mm	77.0	22.0	20.3	6
ST13406SC	15.0 mm	77.0	22.0	22.0	6
ST13407SC	16.0 mm	77.0	22.0	22.0	6
ST13408SC	17.0 mm	77.0	23.8	23.8	6
ST13409SC	18.0 mm	77.0	24.8	24.8	6
ST13410SC	19.0 mm	77.0	25.8	25.8	6
ST13411SC	20.0 mm	77.0	27.8	27.8	4
ST13412SC	21.0 mm	77.0	27.8	27.8	4
ST13413SC	22.0 mm	77.0	29.8	29.8	4
ST13414SC	24.0 mm	77.0	31.8	31.8	4
ST13415SC	27.0 mm	77.0	35.8	35.8	4
ST13416SC	30.0 mm	77.0	39.8	39.8	2
ST13417SC	32.0 mm	77.0	41.8	41.8	2
ST13201SC	3/8"	77.0	22.0	14.5	6
ST13202SC	7/16"	77.0	22.0	17.0	6
ST13203SC	1/2"	77.0	22.0	18.6	6
ST13204SC	9/16"	77.0	22.0	20.6	6
ST13205SC	5/8"	77.0	22.0	22.0	6
ST13206SC	11/16"	77.0	23.8	23.8	6
ST13207SC	3/4"	77.0	25.8	25.8	6
ST13208SC	13/16"	77.0	27.8	27.8	4
ST13209SC	7/8"	77.0	29.8	29.8	4
ST13210SC	15/16"	77.0	31.8	31.8	4
ST13211SC	1"	77.0	33.8	33.8	4
ST13212SC	1.1/16"	77.0	35.8	35.8	4
ST13213SC	1.1/8"	77.0	37.8	37.8	4
SC13214	1.1/4"	77.0	41.8	41.8	6

1/2" Drive 12 Point Deep Socket

- Double hex (12 pt.) fastener end design
- Off-corner loading design reduces fastener rounding
- Deep socket to reach more fasteners
- Large markings offer easy size identification
- Double line (SAE) & knurled line (MM) to easily identify standard and metric sockets
- Manufactured to industrial specifications assuring a thin wall design with precise nut end dimensions
- Heat treated for long lasting durability
- Bright, full polish chrome finish easily wipes clean and resists corrosion
- Chrome vanadium alloy steel (Cr-V) for exceptional strength and durability
- Meets or exceeds ASME B107.110

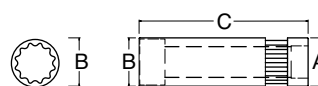

⚠ These sockets accessories should never be used on power drivers, pneumatic impact wrench and/or extenders.

Article Code	Fastener Size	Overall Length (mm) (Dimension C)	Drive End (mm) (Dimension A)	Wrench End (mm) (Dimension B)	
ST13810	10.0 mm	77.0	22.0	15.3	6
ST13812	12.0 mm	77.0	22.0	17.8	6
ST13813	13.0 mm	77.0	22.0	19.0	6
ST13814	14.0 mm	77.0	22.0	20.3	6
ST13816	16.0 mm	77.0	22.0	22.0	6
ST13817	17.0 mm	77.0	23.8	23.8	6
ST13818	18.0 mm	77.0	24.8	24.8	6
ST13819	19.0 mm	77.0	25.8	25.8	6

1/2" Drive 6 Point VDE Insulated Socket

- VDE Certified
- For use in high voltage areas, up to 1000 V alternating current
- Red socket base color for quick identification of VDE
- Single hex (6 pt.) fastener end design
- Off-corner loading design reduces fastener rounding
- Large markings offer easy size identification
- Heat treated for long lasting durability
- Chrome vanadium alloy steel (Cr-V) for exceptional strength and durability
- Meets or exceeds ASME B107.110

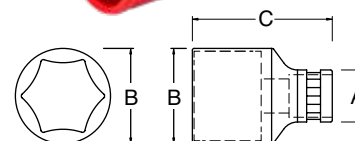

⚠ These sockets accessories should never be used on power drivers, pneumatic impact wrench and/or extenders.

Article Code	Fastener Size	Overall Length (mm) (Dimension C)	Drive End (mm) (Dimension A)	Wrench End (mm) (Dimension B)	
ST14010SC	10.0 mm	55.0	22.0	27.0	12
ST14011SC	11.0 mm	55.0	22.0	27.0	12
ST14012SC	12.0 mm	55.0	22.0	27.0	12
ST14013SC	13.0 mm	55.0	22.0	27.0	12
ST14014SC	14.0 mm	55.0	22.0	27.0	12
ST14016SC	16.0 mm	55.0	22.0	27.0	12
ST14017SC	17.0 mm	55.0	22.0	27.0	12
ST14018SC	18.0 mm	55.0	22.0	27.0	12
ST14019SC	19.0 mm	55.0	22.0	27.0	12
ST14021SC	21.0 mm	55.0	22.0	27.0	10
ST14022SC	22.0 mm	55.0	22.0	27.0	10
ST14024SC	24.0 mm	55.0	22.0	27.0	10

1/2" Drive 6 Point VDE Insulated Hexagon Socket



- VDE Certified
- For use in high voltage areas, up to 1000 V alternating current
- Red socket base color for quick identification of VDE
- Precision engineered bits for a better fit on fasteners
- Large stamped size markings provide quick size identification
- Heat treated for long lasting durability
- S2 steel insert bits offer maximum strength and durability
- Meets or exceeds ASME B107.110



⚠ These sockets accessories should never be used on power drivers, pneumatic impact wrench and/or extenders.

Article Code	Fastener Size	Length (mm)	Width (mm)	Hight (mm)	
ST24404IEC	4.0 mm	117.0	22.0	27.0	6
ST24405IEC	5.0 mm	117.0	22.0	27.0	6
ST24406IEC	6.0 mm	117.0	22.0	27.0	6
ST24408IEC	8.0 mm	117.0	22.0	27.0	18
ST24410IEC	10.0 mm	117.0	22.0	27.0	18

1/2" Drive Spark Plug Sockets

- Single hex (6 pt.) fastener end design
- Off-corner loading design reduces fastener rounding
- Large markings offer easy size identification
- Manufactured to industrial specifications assuring a thin wall design with precise nut end dimensions
- Heat treated for long lasting durability
- Bright, full polish chrome finish easily wipes clean and resists corrosion
- Chrome vanadium alloy steel (Cr-V) for exceptional strength and durability
- Meets or exceeds ASME B107.110



⚠ These sockets accessories should never be used on power drivers, pneumatic impact wrench and/or extenders.

Article Code	Fastener Size	Length (mm)	Width (mm)	Hight (mm)	
ST13915SC	16.0 mm	64.0	45.0	22.0	4
ST13916SC	21.0 mm	70.0	46.0	27.0	4
ST13917SC	5/8"	64.0	45.0	22.9	4
ST13918SC	13/16"	70.0	46.0	27.0	4

1/2" Drive External Torx® Socket

- Off-corner loading design reduces fastener rounding
- Large markings offer easy size identification
- Manufactured to industrial specifications assuring a thin wall design with precise nut end dimensions
- Heat treated for long lasting durability
- Bright, full polish chrome finish easily wipes clean and resists corrosion
- Chrome vanadium alloy steel (Cr-V) for exceptional strength and durability
- Meets or exceeds Camcar TXF-701

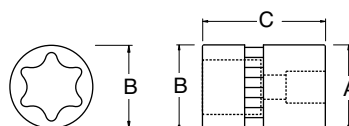

Article Code	Fastener Size	Overall Length (mm) (Dimension C)	Drive End (mm) (Dimension A)	Wrench End (mm) (Dimension B)	
ST13701SC	E10	38.0	22.0	13.3	6
ST13702SC	E12	38.0	22.0	15.0	6
ST13703SC	E14	38.0	22.0	17.0	6
ST13704SC	E16	38.0	22.0	19.0	6
ST13705SC	E18	38.0	23.8	21.0	6
ST13706SC	E20	38.0	25.8	23.5	4
ST13707SC	E22	38.0	25.8	25.8	4
ST13708SC	E24	40.0	27.8	27.8	4

1/2" Drive Quick-Release Stubby Ratchet

- Stubby handle length for improved access
- Quick release design allows rapid socket removal
- Flush mounted reversing lever allows user to change direction with one hand without removing the wrench
- Teardrop, low-profile head and flush-mounted on/off switch allow better access in tight spaces
- Bright, full polish chrome finish easily wipes clean and resists corrosion
- Chrome vanadium alloy steel (Cr-V) for exceptional strength and durability
- Meets or exceeds ASME B107.110



Article Code	Length (mm)	
ST13960SC	194.0	6

1/2" Drive Quick-Release Round Head Ratchet

- Quick release design allows rapid socket removal
- 60-tooth design requires as little as 6° of swing arc to move a fastener
- Bright, full polish chrome finish easily wipes clean and resists corrosion
- Chrome vanadium alloy steel (Cr-V) for exceptional strength and durability
- Meets or exceeds ASME B107.110



Article Code	Length (mm)	
ST13901SC	244.0	4

1/2" Drive Quick-Release Teardrop Ratchet

- Quick release design allows rapid socket removal
- 60-tooth design requires as little as 6° of swing arc to move a fastener
- Flush mounted reversing lever allows user to change direction with one hand without removing the ratchet
- Teardrop, low-profile head and flush-mounted on/off switch allow better access in tight spaces
- Bright, full polish chrome finish easily wipes clean and resists corrosion
- Chrome vanadium alloy steel (Cr-V) for exceptional strength and durability
- Meets or exceeds ASME B107.110



Article Code	Length (mm)	
ST13971ST	250.0	4



Article Code	Length (mm)	
ST13972ST	250.0	4

1/2" Drive Heavy Duty Offset Quick-Release Teardrop Ratchet

- Quick release design allows rapid socket removal
- 60-tooth design requires as little as 6° of swing arc to move a fastener
- Offset handle design provides knuckle clearance in tight access application
- Bright, full polish chrome finish easily wipes clean and resists corrosion
- Chrome vanadium alloy steel (Cr-V) for exceptional strength and durability
- Meets or exceeds ASME B107.110

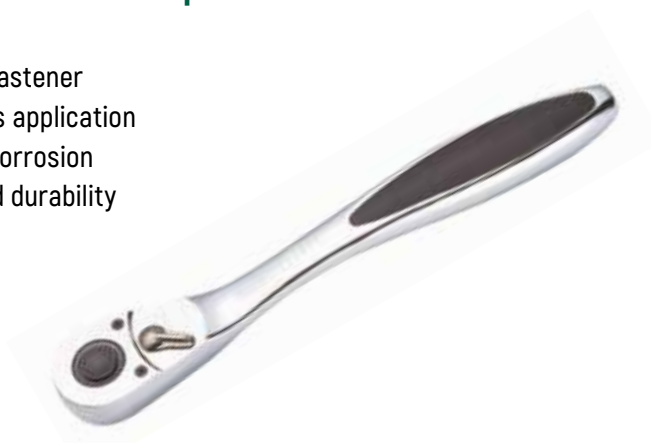

Article Code	Length (mm)	
ST13970SC	261.0	4

1/2" Drive 120XP Ratchet

- Designed with 120 positions providing a 3° swing arc so you can turn fasteners in tighter confines
- Designed with two double stacked 60-tooth pawls for exceptional strength
- Enclosed ratchet head design resists dirt infiltration for continuous and efficient execution
- Up to 50% thinner than conventional ratchet systems
- Teardrop, low-profile head and flush-mounted on/off switch allow better access in tight spaces
- Flush mounted reversing lever allows user to change direction with one hand without removing the wrench
- Bright, full polish chrome finish easily wipes clean and resists corrosion
- Chrome vanadium alloy steel (Cr-V) for exceptional strength and durability
- Meets or exceeds ASME B107.110



Article Code	Length (mm)	
ST13974	250.0	10

1/2" Drive Extendable Ratchet

- Quick release design allows rapid socket removal
- 60-tooth design requires as little as 6° of swing arc to move a fastener
- Flush mounted reversing lever allows user to change direction with one hand without removing the wrench
- Extends from 300 to 440 mm to reach hard-to-reach fasteners (6 positions)
- Ergonomic dual material improves grip and torque while reducing hand fatigue
- Bright, full polish chrome finish easily wipes clean and resists corrosion
- Chrome vanadium alloy steel (Cr-V) for exceptional strength and durability
- Meets or exceeds ASME B107.110



Article Code	Length (mm)	
ST13992BU	300.0 - 440.0	4

1/2" Insulated Quick-Release Teardrop Ratchet

- VDE Certified
- For use in high voltage areas, up to 1000 V alternating current
- Quick release design allows rapid socket removal
- Flush mounted reversing lever allows user to change direction with one hand without removing the wrench
- Teardrop, low-profile head and flush-mounted on/off switch allow better access in tight spaces
- Chrome vanadium alloy steel (Cr-V) for exceptional strength and durability
- Meets or exceeds ASME B107.110



Article Code	Length (mm)	
ST12983SC	250.0	6

1/2" Drive Flex Handle / Breaker Bar

- Handle for more leverage to break stubborn fasteners free
- Flex head drive for multiple angles of use
- One-Piece alloy steel construction for rugged performance
- Ball detent helps to secure the socket to the drive tang
- Bright, full polish chrome finish easily wipes clean and resists corrosion
- Chrome vanadium alloy steel (Cr-V) for exceptional strength and durability
- Meets or exceeds ASME B107.110



Article Code	Size	Length (mm)	
ST13909SC	10"	254	4
ST13911SC	15"	375	4
ST13951SC	17"	432	4

1/2" Drive T-Handle

- Sliding T-Handle provides more leverage to break free stubborn fasteners
- Ball detent for secure socket retention
- Allows for use with one hand on each side of drive tang
- Bright, full polish chrome finish easily wipes clean and resists corrosion
- Chrome vanadium alloy steel (Cr-V) for exceptional strength and durability
- Meets or exceeds ASME B107.110



Article Code	Length (mm)	
ST13910SC	250.0	4

1/2" Drive Speed Handle

- Free rotating top handle grip delivers ultra-fast action for tightening and removing fasteners
- Ball detent for secure socket retention
- Knurled grip for comfort and control
- Bright, full polish chrome finish easily wipes clean and resists corrosion
- Chrome vanadium alloy steel (Cr-V) for exceptional strength and durability
- Meets or exceeds ASME B107.110



Article Code	Length (mm)	
ST17001SC	410.0	6

1/2" Drive Offset Handle

- 10" L-Shaped handle for better leverage and torque to break free stubborn fasteners
- Ball detent helps to secure the socket to the wrench
- Offset handles ideal for working in cramped areas
- Chrome vanadium alloy steel (Cr-V) for exceptional strength and durability
- Meets or exceeds ASME B107.110



Article Code	Length (mm)	
ST13919SC	260.0	4

1/2" Drive Universal Joint

- Universal joint for better access to hard-to-reach fasteners
- Pin hole can be used with detent pin for secure socket retention to the adapter
- Bright, full polish chrome finish easily wipes clean and resists corrosion
- Chrome vanadium alloy steel (Cr-V) for exceptional strength and durability
- Meets or exceeds ASME B107.110



These sockets accessories should never be used on power drivers, pneumatic impact wrench and/or extenders.

Article Code	Length (mm)	
ST13912SC	68.2	4

1/2" Drive Adapter

- Pin hole can be used with detent pin for secure socket retention to the adapter
- Bright, full polish chrome finish easily wipes clean and resists corrosion
- Chrome vanadium alloy steel (Cr-V) for exceptional strength and durability
- Meets or exceeds ASME B107.110



These sockets accessories should never be used on power drivers, pneumatic impact wrench and/or extenders.

Article Code	Size	Length (mm)	
ST13913SC	3/8"	35.1	4
ST13950SC	3/4"	35.1	4

1/2" Drive Bit Adapter

- Precise fit for bit in adapter
- Bright, full polish chrome finish easily wipes clean and resists corrosion
- Chrome vanadium alloy steel (Cr-V) for exceptional strength and durability
- Meets or exceeds ASME B107.110



These sockets accessories should never be used on power drivers, pneumatic impact wrench and/or extenders.

Article Code	
ST13914SC	6

1/2" Drive 3-Way Adapter 3/8"

- 3 Position adapter
- Pin hole can be used with detent pin for secure socket retention to the adapter
- Bright, full polish chrome finish easily wipes clean and resists corrosion
- Chrome vanadium alloy steel (Cr-V) for exceptional strength and durability
- Meets or exceeds ASME B107.110



! These sockets accessories should never be used on power drivers, pneumatic impact wrench and/or extenders.

Article Code	Length (mm)	
ST13930SC	43.6	4

1/2" Drive Wobble Extensions

- Wobble extension for better reach to more fasteners
- Provides better angled access versus standard non-wobble extension bars
- Knurled grip provides a nonslip surface
- Ball detent for secure socket retention
- Bright, full polish chrome finish easily wipes clean and resists corrosion
- Chrome vanadium alloy steel (Cr-V) for exceptional strength and durability
- Meets or exceeds ASME B107.110



! These sockets accessories should never be used on power drivers, pneumatic impact wrench and/or extenders.

Article Code	Size	Length (mm)	
ST13904SC	5"	127.0	4
ST13905SC	10"	254.0	4

1/2" Drive Locking Extensions

- Locking extension for better reach to more fasteners
- Locking mechanism securely attaches socket to extension
- Knurled grip provides a nonslip surface
- Ball detent for secure socket retention
- Bright, full polish chrome finish easily wipes clean and resists corrosion
- Chrome vanadium alloy steel (Cr-V) for exceptional strength and durability
- Meets or exceeds ASME B107.110



! These sockets accessories should never be used on power drivers, pneumatic impact wrench and/or extenders.

Article Code	Size	Length (mm)	
ST13906SC	3"	76.2	4
ST13907SC	5"	127.0	4
ST13908SC	10"	254.0	4

1/2" Insulated Extension



- VDE Certified
- For use in high voltage areas, up to 1000 V alternating current
- Extension for better reach to more fasteners
- Ball detent for secure socket retention
- Chrome vanadium alloy steel (Cr-V) for exceptional strength and durability
- Meets or exceeds ASME B107.110



These sockets accessories should never be used on power drivers, pneumatic impact wrench and/or extenders.

Article Code	Length (mm)	
ST12985SC	55.0	6

1/2" Drive Bit Sockets

- Precision engineered bits for a better fit on fasteners
- Large stamped size markings provide quick size identification
- Heat treated for long lasting durability
- Bright, full polish chrome finish easily wipes clean and resists corrosion
- S2 steel insert bits offer maximum strength and durability
- Meets or exceeds ASME B107.110

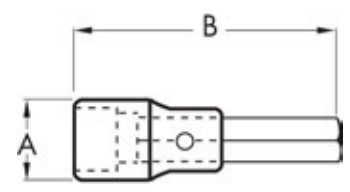

Article Code	Fastener Size	Length (mm) (Dimension B)	Drive End (mm) (Dimension A)	
ST24201SC	Hex 4.0 mm	75.0	24.0	6
ST24202SC	Hex 5.0 mm	75.0	24.0	6
ST24203SC	Hex 6.0 mm	75.0	24.0	6
ST24204SC	Hex 7.0 mm	75.0	24.0	6
ST24205SC	Hex 8.0 mm	75.0	24.0	6
ST24206SC	Hex 10.0 mm	75.0	24.0	6
ST24207SC	Hex 12.0 mm	75.0	24.0	6
ST24208SC	Hex 14.0 mm	75.0	24.0	6
ST24209SC	Hex 17.0 mm	75.0	24.0	6
ST24401BU	Hex 1/4"	75.0	24.0	6
ST24402BU	Hex 5/16"	75.0	24.0	6
ST24403BU	Hex 3/8"	75.0	24.0	6
ST24404BU	Hex 7/16"	75.0	24.0	6
ST24405BU	Hex 1/2"	75.0	24.0	6
ST24406BU	Hex 9/16"	75.0	24.0	6
ST24407BU	Hex 5/8"	75.0	24.0	6



Continued on next page

Continued from previous page

1/2" Drive Bit Sockets

- Precision engineered bits for a better fit on fasteners
- Large stamped size markings provide quick size identification
- Heat treated for long lasting durability
- Bright, full polish chrome finish easily wipes clean and resists corrosion
- S2 steel insert bits offer maximum strength and durability
- Meets or exceeds ASME B107.110

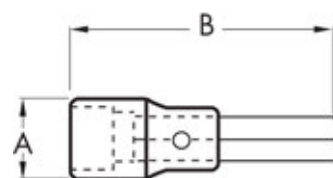

Article Code	Fastener Size	Length (mm) (Dimension B)	Drive End (mm) (Dimension A)	
ST24101SC	Torx® T20	75.0	24.0	6
ST24102SC	Torx® T25	75.0	24.0	6
ST24103SC	Torx® T27	75.0	24.0	6
ST24104SC	Torx® T30	75.0	24.0	6
ST24105SC	Torx® T40	75.0	24.0	6
ST24106SC	Torx® T45	75.0	24.0	6
ST24107SC	Torx® T50	75.0	24.0	6
ST24108SC	Torx® T55	75.0	24.0	6
ST24109SC	Torx® T60	75.0	24.0	6



Article Code	Fastener Size	Length (mm) (Dimension B)	Drive End (mm) (Dimension A)	
ST24801SC	Triple Square M5	75.0	24.0	6
ST24802SC	Triple Square M6	75.0	24.0	6
ST24803SC	Triple Square M8	75.0	24.0	6
ST24804SC	Triple Square M10	75.0	24.0	6
ST24805SC	Triple Square M12	75.0	24.0	6
ST24806SC	Triple Square M14	75.0	24.0	6
ST24807SC	Triple Square M16	75.0	24.0	6



 These sockets accessories should never be used on power drivers, pneumatic impact wrench and/or extenders.

9 Pc. 1/2" Drive Hex Bit Socket Set

Article Code	Size	Length (mm)	Content	
ST09057-02	Hex 10"	254.0	9 - Bit Sockets Hex 4, 5, 6, 7, 8, 10, 12, 14, 17 mm	12

 These sockets accessories should never be used on power drivers, pneumatic impact wrench and/or extenders.



1/2" Drive Long Bit Sockets

- Precision engineered bits for a better fit on fasteners
- Long socket to reach more fasteners
- Large stamped size markings provide quick size identification
- Heat treated for long lasting durability
- Bright, full polish chrome finish easily wipes clean and resists corrosion
- S2 steel insert bits offer maximum strength and durability
- Meets or exceeds ASME B107.110

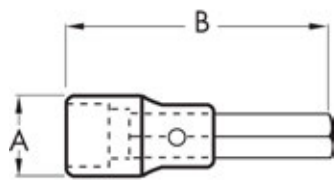

Article Code	Fastener Size	Length (mm) (Dimension B)	Drive End (mm) (Dimension A)	
SC25201	Hex 4.0 mm	125.0	24.0	6
SC25202	Hex 5.0 mm	125.0	24.0	6
SC25203	Hex 6.0 mm	125.0	24.0	6
SC25204	Hex 7.0 mm	125.0	24.0	6
SC25205	Hex 8.0 mm	125.0	24.0	6
SC25206	Hex 10.0 mm	125.0	24.0	6
SC25207	Hex 12.0 mm	125.0	24.0	6
SC25208	Hex 14.0 mm	125.0	24.0	6
SC25209	Hex 17.0 mm	125.0	24.0	6



Article Code	Fastener Size	Length (mm) (Dimension B)	Drive End (mm) (Dimension A)	
SC25101	Torx® T20	125.0	24.0	6
SC25102	Torx® T25	125.0	24.0	6
SC25103	Torx® T27	125.0	24.0	6
SC25104	Torx® T30	125.0	24.0	6
ST25105SC	Torx® T40	125.0	24.0	6
SC25106	Torx® T45	125.0	24.0	6
SC25107	Torx® T50	125.0	24.0	6
SC25108	Torx® T55	125.0	24.0	6
SC25109	Torx® T60	125.0	24.0	6



Article Code	Fastener Size	Length (mm) (Dimension B)	Drive End (mm) (Dimension A)	
SC25801	Triple Square M5	125.0	24.0	6
SC25802	Triple Square M6	125.0	24.0	6
SC25803	Triple Square M8	125.0	24.0	6
SC25804	Triple Square M10	125.0	24.0	6
SC25805	Triple Square M12	125.0	24.0	6
SC25806	Triple Square M14	125.0	24.0	6
SC25807	Triple Square M16	125.0	24.0	6



 These sockets accessories should never be used on power drivers, pneumatic impact wrench and/or extenders.

15 Pc. 3/4" Drive 12 Point Socket Set

Article Code	Description	Content	
ST09015SJ	15 Pc. 3/4" Drive 12 Point Metric Socket Set	1 - Quick-Release Ratchet 10 - 12pt. Metric Sockets 30, 32, 34, 36, 38, 41, 46, 50, 55, 60 mm 4 - Accessories T-Handle Extensions Bars 4", 8" Universal Joint	1
ST09148SJ	15 Pc. 3/4" Drive 12 Point SAE Socket Set	1 - Quick-Release Ratchet 10 - 12pt. Metric Sockets 1", 1-1/8", 1-1/4", 1-5/16", 1-3/8", 1-1/2", 1-5/8", 1-3/4", 1-7/8", 2" 4 - Accessories T-Handle Extensions Bars 4", 8" Universal Joint	1



3/4" Drive 6 Point Socket

- Single hex (6 pt.) fastener end design
- Off-corner loading design reduces fastener rounding
- Large markings offer easy size identification
- Double line (SAE) & knurled line (MM) to easily identify standard and metric sockets
- Manufactured to industrial specifications assuring a thin wall design with precise nut end dimensions
- Heat treated for long lasting durability
- Bright, full polish chrome finish easily wipes clean and resists corrosion
- Chrome vanadium alloy steel (Cr-V) for exceptional strength and durability
- Meets or exceeds ASME B107.110

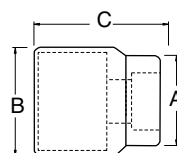

 These sockets accessories should never be used on power drivers, pneumatic impact wrench and/or extenders.

Article Code	Size	Overall Length (mm) (Dimension C)	Drive End (mm) (Dimension A)	Wrench End (mm) (Dimension B)	
ST16401SC	19.0 mm	47.5	36.0	28.5	6
ST16402SC	21.0 mm	49.5	36.0	31.5	6
ST16403SC	22.0 mm	49.5	36.0	32.5	6
ST16404SC	23.0 mm	49.5	36.0	33.5	6
ST16405SC	24.0 mm	49.5	36.0	34.5	6
ST16406SC	25.0 mm	50.0	36.2	35.0	6
ST16407SC	26.0 mm	50.0	37.2	36.0	6

Continued on next page

Article Code	Size	Overall Length (mm) (Dimension C)	Drive End (mm) (Dimension A)	Wrench End (mm) (Dimension B)	
ST16408SC	27.0 mm	52.0	38.2	36.0	6
ST16409SC	28.0 mm	52.0	39.2	36.0	6
ST16410SC	29.0 mm	52.0	40.2	38.0	6
ST16411SC	30.0 mm	54.0	42.2	38.0	6
ST16412SC	32.0 mm	56.0	44.2	38.0	6
ST16413SC	33.0 mm	56.0	46.2	38.0	6
ST16414SC	34.0 mm	56.0	47.2	38.0	6
ST16415SC	35.0 mm	56.0	48.2	42.0	6
ST16416SC	36.0 mm	58.0	50.2	42.0	6
ST16417SC	38.0 mm	60.0	52.5	45.0	4
ST16418SC	41.0 mm	64.0	56.0	45.0	4
ST16419SC	46.0 mm	68.0	62.0	48.0	4
ST16420SC	50.0 mm	72.0	68.0	48.0	2
ST16421SC	55.0 mm	76.0	74.0	48.0	2
ST16422SC	60.0 mm	78.0	80.0	48.0	2
ST16301SC	3/4"	49.5	36.0	29.5	6
ST16302SC	13/16"	49.5	36.0	31.5	6
ST16303SC	7/8"	49.5	36.0	32.5	6
ST16304SC	15/16"	49.5	36.0	34.5	6
ST16305SC	1"	50.0	36.0	35.0	6
ST16306SC	1.1/16"	52.0	37.8	36.0	6
ST16307SC	1.1/8"	54.0	39.8	36.0	6
ST16308SC	1.3/16"	54.0	41.8	38.0	6
ST16309SC	1.1/4"	56.0	44.2	38.0	6
ST16310SC	1.5/16"	56.0	46.2	38.0	6
ST16311SC	1.3/8"	56.0	48.2	42.0	6
ST16312SC	1.7/16"	60.0	48.2	42.0	6
ST16313SC	1.1/2"	60.0	50.2	42.0	4
ST16320SC	1.9/16"	60.0	52.5	45.0	4
ST16314SC	1.5/8"	64.0	53.5	45.0	4
ST16315SC	1.11/16"	68.0	56.0	45.0	4
ST16316SC	1.3/4"	68.0	57.0	45.0	4
ST16317SC	1.13/16"	68.0	60.5	45.0	4
ST16318SC	1.7/8"	72.0	63.5	48.0	2
ST16319SC	2"	73.0	68.0	48.0	2
ST16321SC	2.1/16"	74.0	70.5	48.0	2
ST16322SC	2.1/8"	76.0	72.0	48.0	2
ST16323SC	2.1/4"	80.0	76.0	48.0	2

3/4" Drive 12 Point Socket

- Double hex (12 pt.) fastener end design
- Off-corner loading design reduces fastener rounding
- Large markings offer easy size identification
- Double line (SAE) & knurled line (MM) to easily identify standard and metric sockets
- Manufactured to industrial specifications assuring a thin wall design with precise nut end dimensions
- Heat treated for long lasting durability
- Bright, full polish chrome finish easily wipes clean and resists corrosion
- Chrome vanadium alloy steel (Cr-V) for exceptional strength and durability
- Meets or exceeds ASME B107.110

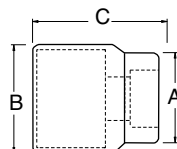

 These sockets accessories should never be used on power drivers, pneumatic impact wrench and/or extenders.

Article Code	Size	Overall Length (mm) (Dimension C)	Drive End (mm) (Dimension A)	Wrench End (mm) (Dimension B)	
ST16602SC	19.0 mm	47.5	36.0	28.5	6
ST16603SC	21.0 mm	49.5	36.0	31.5	6
ST16604SC	22.0 mm	49.5	36.0	32.5	6
ST16605SC	23.0 mm	49.5	36.0	33.5	6
ST16606SC	24.0 mm	49.5	36.0	34.5	6
ST16607SC	25.0 mm	50.0	36.2	35.0	6
ST16608SC	26.0 mm	50.0	37.2	36.0	6
ST16609SC	27.0 mm	52.0	38.2	36.0	6
ST16610SC	28.0 mm	52.0	39.2	36.0	6
ST16611SC	29.0 mm	52.0	40.2	38.0	6
ST16612SC	30.0 mm	54.0	42.2	38.0	6
ST16613SC	32.0 mm	56.0	44.2	38.0	6
ST16614SC	33.0 mm	56.0	46.2	38.0	6
ST16615SC	34.0 mm	56.0	47.2	38.0	6
ST16616SC	35.0 mm	56.0	48.2	42.0	6
ST16617SC	36.0 mm	58.0	50.2	42.0	6
ST16618SC	38.0 mm	60.0	52.5	45.0	4
ST16619SC	41.0 mm	64.0	56.0	45.0	4
ST16620SC	46.0 mm	68.0	62.0	48.0	4
ST16622SC	50.0 mm	72.0	68.0	48.0	2
ST16623SC	55.0 mm	76.0	74.0	48.0	2
ST16624SC	60.0 mm	78.0	80.0	48.0	2

Continued on next page

Article Code	Size	Overall Length (mm) (Dimension C)	Drive End (mm) (Dimension A)	Wrench End (mm) (Dimension B)	
ST16504SC	15/16"	49.5	36.0	34.5	6
ST16501SC	3/4"	49.5	36.0	29.5	6
ST16502SC	13/16"	49.5	36.0	31.5	6
ST16503SC	7/8"	49.5	36.0	32.5	6
ST16505SC	1"	50.0	36.0	35.0	6
ST16506SC	1.1/16"	52.0	37.8	36.0	6
ST16507SC	1.1/8"	54.0	39.8	36.0	6
ST16508SC	1.3/16"	54.0	41.8	38.0	6
ST16509SC	1.1/4"	56.0	44.2	38.0	6
ST16510SC	1.5/16"	56.0	46.2	38.0	6
ST16511SC	1.3/8"	56.0	48.2	42.0	6
ST16512SC	1.7/16"	60.0	48.2	42.0	6
ST16513SC	1.1/2"	60.0	50.2	42.0	4
ST16520SC	1.9/16"	60.0	52.5	45.0	4
ST16514SC	1.5/8"	64.0	53.5	45.0	4
ST16515SC	1.11/16"	68.0	56.0	45.0	4
ST16516SC	1.3/4"	68.0	57.0	45.0	4
ST16517SC	1.13/16"	68.0	60.5	45.0	4
ST16518SC	1.7/8"	72.0	63.5	48.0	2
ST16519SC	2"	73.0	68.0	48.0	2
ST16521SC	2.1/16"	74.0	70.5	48.0	2
ST16522SC	2.1/8"	76.0	72.0	48.0	2
ST16523SC	2.1/4"	80.0	76.0	48.0	2

3/4" Drive Quick-Release Teardrop Ratchet

- Quick release design allows rapid socket removal
- Flush mounted reversing lever allows user to change direction with one hand without removing the wrench
- Teardrop, low-profile head and flush-mounted on/off switch allow better access in tight spaces
- Bright, full polish chrome finish easily wipes clean and resists corrosion
- Chrome vanadium alloy steel (Cr-V) for exceptional strength and durability
- Meets or exceeds ASME B107.110



Article Code	Length (mm)	
ST16901SC	500.0	1

3/4" Drive Flex Handle / Breaker Bar 19"

- Handle for more leverage to break stubborn fasteners free
- Flex head drive for multiple angles of use
- One-Piece alloy steel construction for rugged performance
- Ball detent helps to secure the socket to the drive tang
- Bright, full polish chrome finish easily wipes clean and resists corrosion
- Chrome vanadium alloy steel (Cr-V) for exceptional strength and durability
- Meets or exceeds ASME B107.110



Article Code	Length (mm)	
ST16906SC	450.0	1

3/4" Drive T-Handle

- Sliding T-Handle provides more leverage to break free stubborn fasteners
- Ball detent for secure socket retention
- Allows for use with one hand on each side of drive tang
- Bright, full polish chrome finish easily wipes clean and resists corrosion
- Chrome vanadium alloy steel (Cr-V) for exceptional strength and durability
- Meets or exceeds ASME B107.110



Article Code	Length (mm)	
ST16905SC	450.0	1

3/4" Drive Offset Handle

- 13" L-Shaped handle for better leverage and torque to break free stubborn fasteners
- Ball detent helps to secure the socket to the wrench
- Offset handles ideal for working in cramped areas
- Chrome vanadium alloy steel (Cr-V) for exceptional strength and durability
- Meets or exceeds ASME B107.110



Article Code	Length (mm)	
ST16919SC	380.0	4

3/4" Drive Universal Joint

- Universal joint for better access to hard-to-reach fasteners
- Pin hole can be used with detent pin for secure socket retention to the adapter
- Bright, full polish chrome finish easily wipes clean and resists corrosion
- Chrome vanadium alloy steel (Cr-V) for exceptional strength and durability
- Meets or exceeds ASME B107.110



 These sockets accessories should never be used on power drivers, pneumatic impact wrench and/or extenders.

Article Code	Length (mm)	
ST16907SC	75.2	3

3/4" Drive Adapter 1/2"

- Pin hole can be used with detent pin for secure socket retention to the adapter
- Bright, full polish chrome finish easily wipes clean and resists corrosion
- Chrome vanadium alloy steel (Cr-V) for exceptional strength and durability
- Meets or exceeds ASME B107.110



 These sockets accessories should never be used on power drivers, pneumatic impact wrench and/or extenders.

Article Code	Length (mm)	
ST16908SC	35.1	6

3/4" Drive Standard Extension Bar

- Locking extension for better reach to more fasteners
- Ball detent for secure socket retention
- Bright, full polish chrome finish easily wipes clean and resists corrosion
- Chrome vanadium alloy steel (Cr-V) for exceptional strength and durability
- Meets or exceeds ASME B107.110



 These sockets accessories should never be used on power drivers, pneumatic impact wrench and/or extenders.

Article Code	Size	Length (mm)	
ST16902SC	4"	102.0	6
ST16903SC	8"	203.0	3
ST16904SC	16"	406.0	2

Pass-Thru[®] Ratchet & Socket Systems



30 Pc. 1/4" and 3/8" Drive 6 Point Metric Pass-Thru® Socket Set

Article Code	Content	
ST09132SJ	1 - 1/4" Dr. Pass-Thru® Ratchet 1 - 3/8" Dr. Pass-Thru® Ratchet 13 - 1/4" Dr. Metric Pass-Thru® Sockets 3.5, 4, 4.5, 5, 5.5, 6, 7, 8, 9, 10, 11, 12, 13 mm 10 - 3/8" Dr. Metric Pass-Thru® Sockets 10, 11, 12, 13, 14, 15, 16, 17, 18, 19 mm 5 - Accessories 1/4" Dr. Pass-Thru® Extension Bar 3" 1/4" Dr. Quick-Release Adapter 3/8" Dr. Pass-Thru® Extension Bar 3" 3/8" Dr. x1/4" M Quick-Release Adapter 3/8" Dr. x3/8" M Quick-Release Adapter	4



04

21 Pc. 3/8" Drive 6 Point Metric/SAE Pass-Thru® Socket Set

Article Code	Content	
ST09134SJ	1 - Pass-Thru® Ratchet 10 - Metric Pass-Thru® Sockets 10, 11, 12, 13, 14, 15, 16, 17, 18, 19 mm 7 - SAE Pass-Thru® Sockets 3/8, 7/16, 1/2, 5/8, 9/16, 11/16, 3/4" 3 - Accessories 3/8" Dr. x1/4" M Quick-Release Adapter 3/8" Dr. x3/8" M Quick-Release Adapter Pass-Thru® Extension Bar 3"	3



25 Pc. 1/4" Drive 6 Point Metric/SAE Pass-Thru® Socket Set

Article Code	Content	
ST09131SJ	1 - Pass-Thru® Ratchet 13 - Metric Pass-Thru® Sockets 3.5, 4, 4.5, 5, 5.5, 6, 7, 8, 9, 10, 11, 12, 13 mm 9 - SAE Pass-Thru® Sockets 5/32, 3/16, 7/32, 1/4, 9/32, 5/16, 3/8, 7/16, 1/2" 2 - Accessories Quick-Release Adapter Pass-Thru® Extension Bar 3"	6



BoltBiter



1/4" AND 3/8" DRIVE METRIC/SAE BOLTBITER SETS

ST09137
ST09138

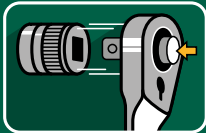

Rapid socket removal

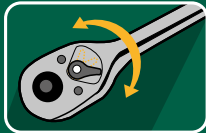

Flush reversing lever

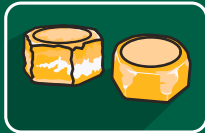

Removes rusted and rounded fasteners



Innovative tapered flutes

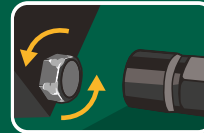

Bi-directional design

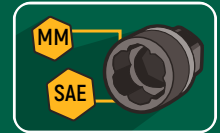

Dual sized sockets

SAE

METRIC

1/4"

3/8"



13 Pc. 1/4" and 3/8" Drive Metric/SAE BoltBiter Set

- Ratchet with quick release design allows rapid socket removal
- Ratchet flush mounted reversing lever allows user to change direction with one hand without removing the wrench
- Removes rusted and rounded fasteners
- Innovative tapered flutes for easy seating onto a damaged fastener
- Bi-directional design removes or tightens damaged fasteners
- Dual sized sockets work with both SAE and metric fasteners
- Hexagonal base for use with impact guns, ratchets, wrenches, or pliers
- Up to 5 times greater gripping force
- Chrome molybdenum alloy steel (Cr-Mo) for exceptional strength and durability
- Comes with a durable blow mold case for storage and organization

Article Code	Content	
ST09137	1 - 3/8" Dr. Quick-Release Ratchet 2 - 1/4" Extraction Sockets 7, 8 mm 8 - 3/8" Extraction Sockets 10, 11, 12, 13, 14, 16, 17, 19 mm 2 - Accessories 3/8" Drive Wobble Extension Bar 6" 3/8" Drive Adapter 3/8"FX1/4"M	4



23 PC. 1/4" and 3/8" Drive Metric/SAE BoltBiter Set

- Ratchet with quick release design allows rapid socket removal
- Ratchet flush mounted reversing lever allows user to change direction with one hand without removing the wrench
- Removes rusted and rounded fasteners
- Minus-sized sockets designed to fit extremely worn-down fasteners
- Innovative tapered flutes for easy seating onto a damaged fastener
- Bi-directional design removes or tightens damaged fasteners
- Dual sized sockets work with both SAE and metric fasteners
- Hexagonal base for use with impact guns, ratchets, wrenches, or pliers
- Up to 5 times greater gripping force
- Chrome molybdenum alloy steel (Cr-Mo) for exceptional strength and durability
- Comes with a durable blow mold case for storage and organization

Article Code	Content	
ST09138	1 - 3/8" Dr. Quick-Release Ratchet 2 - 1/4" Extraction Sockets 7, 8 mm 2 - 1/4" Minus Sized Extraction Sockets -7, -8 mm 8 - 3/8" Extraction Sockets 10, 11, 12, 13, 14, 16, 17, 19 mm 8 - 3/8" Minus Sized Extraction Sockets -10, -11, -12, -13, -14, -16, -17, -19 mm 2 - Accessories 3/8" Drive Wobble Extension Bar 6" 3/8" Drive Adapter 3/8"FX1/4"M	4



BoltBiter Extraction Socket

- Removes rusted and rounded fasteners
- Minus-sized sockets designed to fit extremely worn-down fasteners
- Innovative tapered flutes for easy seating onto a damaged fastener
- Bi-directional design removes or tightens damaged fasteners
- Dual sized sockets work with both SAE and metric fasteners
- Hexagonal base for use with impact guns, ratchets, wrenches, or pliers
- High-visibility laser-etched markings for quick size identification
- Chrome molybdenum alloy steel (Cr-Mo) for exceptional strength and durability
- Black oxide finish to resist corrosion
- Meets or exceeds ASME B107.110

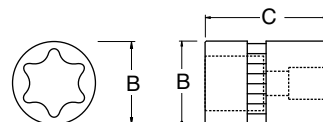

Article Code	Fastener Size	Drive Size	Overall Length (mm) (Dimension C)	Wrench End (mm) (Dimension B)	
SC12801	-7.0 mm	1/4"	37.5	18.0	6
SC12802	7.0 mm	1/4"	37.5	18.0	6
SC12803	-8.0 mm / -5/16"	1/4"	37.5	18.0	6
SC12804	8.0 mm / 5/16"	1/4"	37.5	18.0	6
SC12807	-10.0 mm	3/8"	37.5	21.4	6
SC12808	10.0 mm	3/8"	37.5	21.4	6
SC12809	-11.0 mm / -7/16"	3/8"	37.5	21.4	6
SC12810	11.0 mm / 7/16"	3/8"	37.5	21.4	6
SC12811	-12.0 mm	3/8"	37.5	21.4	6
SC12812	12.0 mm	3/8"	37.5	21.4	6
SC12814	-13.0 mm / -1/2"	3/8"	37.5	21.4	6
SC12815	13.0 mm / 1/2"	3/8"	37.5	21.4	6
SC12816	-14.0 mm / -9/16"	3/8"	37.5	22.0	6
SC12817	14.0 mm / 9/16"	3/8"	37.5	22.0	6
SC12820	-16.0 mm / -5/8"	3/8"	37.5	24.0	6
SC12821	16.0 mm / 5/8"	3/8"	37.5	24.0	6
SC12822	-17.0 mm	3/8"	37.5	24.0	6
SC12823	17.0 mm	3/8"	37.5	26.0	6
SC12826	-19.0 mm / -3/4"	3/8"	37.5	28.0	6
SC12827	19.0 mm / 3/4"	3/8"	37.5	28.0	6



Impact Sockets



1/4" Drive Impact Adapter 1/4"F X 3/8"M

- Pin hole can be used with detent pin for secure socket retention to the adapter
- For use with impact drivers
- Black oxide finish to resist corrosion
- Chrome molybdenum alloy steel (Cr-Mo) for exceptional strength and durability
- Meets or exceeds ASME B107.110



Article Code	Length (mm)	
ST34714SC	26.5	6

3/8" Drive Impact Adapter 3/8"F X 1/2"M

- Pin hole can be used with detent pin for secure socket retention to the adapter
- For use with impact drivers
- Black oxide finish to resist corrosion
- Chrome molybdenum alloy steel (Cr-Mo) for exceptional strength and durability
- Meets or exceeds ASME B107.110



Article Code	Length (mm)	
ST34715SC	36.0	6

3/8" Drive Impact Universal Joint

- Universal joint for better access to hard-to-reach fasteners
- Pin hole can be used with detent pin for secure socket retention to the adapter
- For use with impact drivers
- Black oxide finish to resist corrosion
- Chrome molybdenum alloy steel (Cr-Mo) for exceptional strength and durability
- Meets or exceeds ASME B107.110



Article Code	Length (mm)	
ST32902	53.0	6

3/8" Drive Impact Extension

- Extension for better reach to more fasteners
- For use with impact drivers
- Ball detent for secure socket retention
- Black oxide finish to resist corrosion
- Chrome molybdenum alloy steel (Cr-Mo) for exceptional strength and durability
- Meets or exceeds ASME B107.110



Article Code	Size	Length (mm)	
ST34701SC	3"	75.0	6
ST34702SC	6"	150.0	6

3/8" Drive 6 Point Impact Socket

- Single hex (6 pt.) fastener end design
- For use with impact drivers
- Off-corner loading design reduces fastener rounding
- Large markings offer easy size identification
- Black oxide finish to resist corrosion
- Chrome molybdenum alloy steel (Cr-Mo) for exceptional strength and durability
- Meets or exceeds ASME B107.110

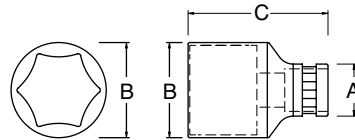

Article Code	Fastener Size	Overall Length (mm) (Dimension C)	Drive End (mm) (Dimension A)	Wrench End (mm) (Dimension B)	
ST34201BU	6.0 mm	28.0	10.6	18.8	6
ST34202SC	7.0 mm	28.0	11.6	18.8	6
ST34203SC	8.0 mm	28.0	12.8	18.8	6
SC34204	9.0 mm	28.0	14.2	18.8	6
ST34205SC	10.0 mm	28.0	15.9	18.8	6
ST34206SC	11.0 mm	28.0	17.1	18.8	6
ST34207SC	12.0 mm	28.0	18.5	18.8	6
ST34208SC	13.0 mm	30.0	20.0	19.8	6
ST34209SC	14.0 mm	30.0	21.0	21.8	6
SC34210	15.0 mm	30.0	21.0	22.0	6
ST34211SC	16.0 mm	30.0	22.0	23.8	6
ST34212SC	17.0 mm	30.0	22.0	24.8	6
SC34213	18.0 mm	30.0	22.0	25.8	6
ST34214SC	19.0 mm	30.0	22.0	26.8	6

12 Pc. 1/2" Drive 6 Point Metric Impact Socket Set

Article Code	Content	
ST09009SJ	10 - 6pt. Metric Impact Sockets 10, 11, 13, 14, 17, 19, 21, 22, 23, 24 mm 2 - Accessories Impact Universal Joint Impact Extension Bar 5"	8



14 Pc. 1/2" Drive 6 Point Metric Thin Wall Impact Socket Set

Article Code	Content	
ST34397T	10, 11, 12, 13, 14, 15, 16, 17, 18, 19, 21, 22, 23, 24 mm	12

 Excluded from Lifetime Warranty terms



13 Pc. 1/2" Drive 6 Point Metric Deep Thin Wall Impact Socket Set

Article Code	Content	
ST34398T	10, 11, 12, 13, 14, 15, 16, 17, 18, 19, 21, 22, 24 mm	6

 Excluded from Lifetime Warranty terms



12 Pc. 1/2" Drive 6 Point SAE Impact Socket Set

Article Code	Content	
ST09008SJ	10 - 6pt. SAE Impact Sockets 7/16", 1/2", 9/16", 5/8", 11/16", 3/4", 13/16", 7/8", 15/16", 1" 2 - Accessories Impact Universal Joint Impact Extension Bar 5"	10



26 PC. 1/2" DRIVE 6 POINT METRIC STANDARD & DEEP THIN WALL IMPACT SOCKET SET

ST34399T



Thin wall socket design

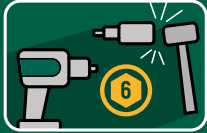

For use with impact drivers



Single hex (6 pt.) fastener end



Sockets feature off-corner loading

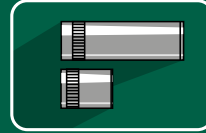

Standard & deep sockets

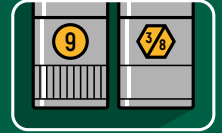

Large easy ID size markings

METRIC

1/2"



26 Pc. 1/2" Drive 6 Point Metric Standard & Deep Thin Wall Impact Socket Set

Article Code	Content	
ST34399T	13 - 6pt. Metric Thin Wall Impact Sockets 10, 11, 12, 13, 14, 15, 16, 17, 18, 19, 21, 22, 24 mm 13 - 6pt. Metric Thin Wall Deep Impact Sockets 10, 11, 12, 13, 14, 15, 16, 17, 18, 19, 21, 22, 24 mm	5

 Excluded from Lifetime Warranty terms



1/2" Drive Impact Adapter

- Pin hole can be used with detent pin for secure socket retention to the adapter
- For use with impact drivers
- Black oxide finish to resist corrosion
- Chrome molybdenum alloy steel (Cr-Mo) for exceptional strength and durability
- Meets or exceeds ASME B107.110



Article Code	Size	Length (mm)	
ST34716SC	1/2" F X 3/8" M	38.0	20
ST34717SC	1/2" F X 3/4" M	45.0	6

1/2" Drive Impact Universal Joint

- Universal joint for better access to hard-to-reach fasteners
- Pin hole can be used with detent pin for secure socket retention to the adapter
- For use with impact drivers
- Black oxide finish to resist corrosion
- Chrome molybdenum alloy steel (Cr-Mo) for exceptional strength and durability
- Meets or exceeds ASME B107.110



Article Code	Length (mm)	
ST34719SC	65.5	6

1/2" Drive Impact Extension

- Extension for better reach to more fasteners
- For use with impact drivers
- Ball detent for secure socket retention
- Black oxide finish to resist corrosion
- Chrome molybdenum alloy steel (Cr-Mo) for exceptional strength and durability
- Meets or exceeds ASME B107.110



Article Code	Size	Length (mm)	
ST33911SC	3"	75.0	4
ST34703SC	5"	125.0	6
ST34704SC	6"	150.0	6
ST34705SC	10"	250.0	6
ST34706SC	12"	300.0	6

1/2" Drive 6 Point Impact Socket

- Single hex (6 pt.) fastener end design
- For use with impact drivers
- Off-corner loading design reduces fastener rounding
- Large markings offer easy size identification
- Black oxide finish to resist corrosion
- Chrome molybdenum alloy steel (Cr-Mo) for exceptional strength and durability
- Meets or exceeds ASME B107.110

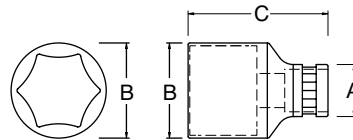

Article Code	Fastener Size	Overall Length (mm) (Dimension C)	Drive End (mm) (Dimension A)	Wrench End (mm) (Dimension B)	
ST34303SC	10.0 mm	38.0	24.8	14.5	6
ST34304SC	11.0 mm	38.0	24.8	15.4	6
ST34305SC	12.0 mm	38.0	24.8	17.8	6
ST34306SC	13.0 mm	38.0	24.8	18.3	6
ST34307SC	14.0 mm	38.0	24.8	19.5	6
ST34308SC	15.0 mm	38.0	24.8	20.4	6
ST34309SC	16.0 mm	38.0	24.8	21.8	6
ST34310SC	17.0 mm	38.0	25.8	23.2	6
ST34311SC	18.0 mm	38.0	27.8	24.6	4
ST34312SC	19.0 mm	41.0	29.8	27.2	4
ST34314SC	21.0 mm	41.0	31.8	27.4	4
ST34315SC	22.0 mm	41.0	31.8	30.0	4
ST34316SC	23.0 mm	41.0	33.8	30.0	4
ST34317SC	24.0 mm	41.0	33.8	30.0	4

Continued on next page

Article Code	Fastener Size	Overall Length (mm) (Dimension C)	Drive End (mm) (Dimension A)	Wrench End (mm) (Dimension B)	
ST34320SC	27.0 mm	41.0	37.8	30.0	4
ST34322SC	29.0 mm	41.0	41.8	31.0	2
ST34323SC	30.0 mm	41.0	41.8	32.0	2
ST34325SC	32.0 mm	41.0	43.8	34.0	2
ST33101SC	7/16"	38.0	24.8	17.5	6
ST33102SC	1/2"	38.0	24.8	20.5	6
ST33103SC	9/16"	38.0	24.8	21.7	6
ST33104SC	5/8"	38.0	24.8	23.2	6
ST33105SC	11/16"	38.0	25.8	24.6	6
ST33106SC	3/4"	41.0	29.8	27.2	4
ST33107SC	13/16"	41.0	31.8	28.4	4
ST33108SC	7/8"	41.0	31.8	30.0	4
ST33109SC	15/16"	41.0	35.8	30.0	4
ST33110SC	1"	41.0	37.8	30.0	4

1/2" Drive 6 Point Thin Wall Impact Socket

- Thin wall socket design for access in spaces standard sockets will not fit
- Single hex (6 pt.) fastener end design
- For use with impact drivers
- Off-corner loading design reduces fastener rounding
- Large markings offer easy size identification
- Black oxide finish to resist corrosion
- Chrome molybdenum alloy steel (Cr-Mo) for exceptional strength and durability
- Meets or exceeds ASME B107.110

 Excluded from Lifetime Warranty terms

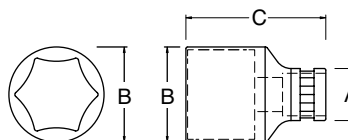

Article Code	Fastener Size	Overall Length (mm) (Dimension C)	Drive End (mm) (Dimension A)	Wrench End (mm) (Dimension B)	
SC34303T	10.0 mm	38.0	21.8	15.3	6
SC34304T	11.0 mm	38.0	21.8	16.5	6
SC34305T	12.0 mm	38.0	21.8	17.8	6
SC34306T	13.0 mm	38.0	23.8	19.0	6
SC34307T	14.0 mm	38.0	23.8	20.3	6
SC34308T	15.0 mm	38.0	23.8	21.5	6
SC34309T	16.0 mm	38.0	23.8	22.8	6
SC34310T	17.0 mm	38.0	23.8	23.2	6
SC34311T	18.0 mm	38.0	24.8	24.6	4
SC34312T	19.0 mm	41.0	25.8	27.2	4
SC34314T	21.0 mm	41.0	27.8	28.4	4
SC34315T	22.0 mm	41.0	29.5	30.0	4
SC34316T	23.0 mm	41.0	31.1	30.0	4
SC34317T	24.0 mm	41.0	31.8	30.0	4
SC34320T	27.0 mm	41.0	35.8	32.5	4

1/2" Drive 6 Point Impact Deep Socket

- Single hex (6 pt.) fastener end design
- For use with impact drivers
- Off-corner loading design reduces fastener rounding
- Deep socket to reach more fasteners
- Large markings offer easy size identification
- Black oxide finish to resist corrosion
- Chrome molybdenum alloy steel (Cr-Mo) for exceptional strength and durability
- Meets or exceeds ASME B107.110

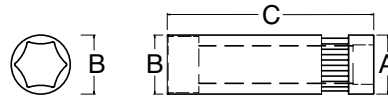



Article Code	Fastener Size	Overall Length (mm) (Dimension C)	Drive End (mm) (Dimension A)	Wrench End (mm) (Dimension B)	
ST34403SC	10.0 mm	82.0	24.3	14.7	6
ST34404SC	11.0 mm	82.0	24.3	15.7	6
ST34405SC	12.0 mm	82.0	24.3	18.1	6
ST34406SC	13.0 mm	82.0	24.3	18.9	6
ST34407SC	14.0 mm	82.0	24.3	20.6	4
ST34408SC	15.0 mm	82.0	24.3	21.5	6
ST34409SC	16.0 mm	82.0	24.3	22.8	6
ST34410SC	17.0 mm	82.0	25.8	23.2	6
ST34411SC	18.0 mm	82.0	27.8	24.6	6
ST34412SC	19.0 mm	82.0	29.8	27.2	4
ST34414SC	21.0 mm	82.0	31.3	28.4	4
ST34415SC	22.0 mm	82.0	31.8	30.0	4
ST34417SC	24.0 mm	82.0	33.8	30.0	4
ST34419SC	26.0 mm	82.0	37.8	30.0	4
ST34420SC	27.0 mm	82.0	37.8	30.0	4
ST34422SC	29.0 mm	82.0	39.8	31.0	2
ST34423SC	30.0 mm	82.0	41.8	32.0	2
ST34425SC	32.0 mm	82.0	43.8	34.0	2

1/2" Drive 6 Point Thin Wall Impact Deep Socket

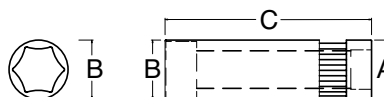
- Thin wall socket design for access in spaces standard sockets will not fit
- Single hex (6 pt.) fastener end design
- For use with impact drivers
- Off-corner loading design reduces fastener rounding
- Deep socket to reach more fasteners
- Large markings offer easy size identification
- Black oxide finish to resist corrosion
- Chrome molybdenum alloy steel (Cr-Mo) for exceptional strength and durability
- Meets or exceeds ASME B107.110



 Excluded from Lifetime Warranty terms

Article Code	Fastener Size	Overall Length (mm) (Dimension C)	Drive End (mm) (Dimension A)	Wrench End (mm) (Dimension B)	
SC34403T	10.0 mm	82.0	21.8	15.3	6
SC34404T	11.0 mm	82.0	21.8	16.5	6
SC34405T	12.0 mm	82.0	21.8	17.8	6
SC34406T	13.0 mm	82.0	23.8	19.0	6
SC34407T	14.0 mm	82.0	23.8	20.3	6
SC34408T	15.0 mm	82.0	23.8	21.5	6
SC34409T	16.0 mm	82.0	23.8	22.8	6
SC34410T	17.0 mm	82.0	23.8	23.2	6
SC34411T	18.0 mm	82.0	24.8	24.6	6
SC34412T	19.0 mm	82.0	25.8	27.2	4
SC34414T	21.0 mm	82.0	27.8	28.4	4
SC34415T	22.0 mm	82.0	29.5	30.0	4
SC34417T	24.0 mm	82.0	31.8	30.0	4
SC34420T	27.0 mm	82.0	35.8	30.0	4

3/4" Drive Impact Adapter

- Pin hole can be used with detent pin for secure socket retention to the adapter
- For use with impact drivers
- Black oxide finish to resist corrosion
- Chrome molybdenum alloy steel (Cr-Mo) for exceptional strength and durability
- Meets or exceeds ASME B107.110



Article Code	Size	Length (mm)	
ST34718SC	3/4" F X 1/2" M	56.0	6
ST34721SC	3/4" F X 1" M	57.0	4

3/4" Drive Impact Universal Joint

- Universal joint for better access to hard-to-reach fasteners
- Pin hole can be used with detent pin for secure socket retention to the adapter
- For use with impact drivers
- Black oxide finish to resist corrosion
- Chrome molybdenum alloy steel (Cr-Mo) for exceptional strength and durability
- Meets or exceeds ASME B107.110



Article Code	Length (mm)	
ST34720SC	88.5	6

3/4" Drive Impact Extension

- Extension for better reach to more fasteners
- For use with impact drivers
- Ball detent for secure socket retention
- Black oxide finish to resist corrosion
- Chrome molybdenum alloy steel (Cr-Mo) for exceptional strength and durability
- Meets or exceeds ASME B107.110



Article Code	Size	Length (mm)	
ST34708SC	4"	100.0	3
ST34712SC	10"	250.0	1

3/4" Drive 6 Point Impact Socket

- Single hex (6 pt.) fastener end design
- For use with impact drivers
- Off-corner loading design reduces fastener rounding
- Large markings offer easy size identification
- Black oxide finish to resist corrosion
- Chrome molybdenum alloy steel (Cr-Mo) for exceptional strength and durability

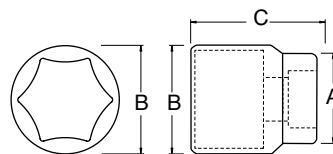

Article Code	Fastener Size	Overall Length (mm) (Dimension C)	Drive End (mm) (Dimension A)	Wrench End (mm) (Dimension B)	
ST34505SC	17.0 mm	51.0	30.0	38.0	6
ST34506SC	18.0 mm	51.0	31.0	38.0	6
ST34507SC	19.0 mm	51.0	32.0	38.0	6

Continued on next page

Article Code	Fastener Size	Overall Length (mm) (Dimension C)	Drive End (mm) (Dimension A)	Wrench End (mm) (Dimension B)	
ST34508SC	20.0 mm	51.0	33.0	38.0	6
ST34509SC	21.0 mm	51.0	34.0	38.0	6
ST34510SC	22.0 mm	51.0	35.0	38.0	6
ST34511SC	23.0 mm	51.0	36.0	38.0	6
ST34512SC	24.0 mm	51.0	38.0	38.0	6
ST34513SC	25.0 mm	51.0	38.0	38.0	6
ST34514SC	26.0 mm	51.0	38.0	38.0	6
ST34515SC	27.0 mm	53.0	40.0	40.0	6
ST34516SC	28.0 mm	53.0	40.0	40.0	6
ST34517SC	29.0 mm	53.0	42.0	42.0	6
ST34518SC	30.0 mm	53.0	44.0	44.0	6
ST34519SC	31.0 mm	53.0	48.0	44.0	6
ST34520SC	32.0 mm	57.0	48.0	44.0	6
ST34521SC	33.0 mm	57.0	48.0	44.0	6
ST34522SC	34.0 mm	57.0	51.0	44.0	6
ST34523SC	35.0 mm	57.0	50.0	44.0	6
ST34524SC	36.0 mm	57.0	52.0	44.0	6
ST34525SC	37.0 mm	57.0	55.0	44.0	6
ST34526SC	38.0 mm	57.0	56.0	44.0	6
ST34527SC	39.0 mm	57.0	58.0	44.0	6
ST34528SC	40.0 mm	57.0	59.0	44.0	6
ST34529SC	41.0 mm	57.0	60.0	44.0	6
ST34530	42.0 mm	57.0	61.0	44.0	6
ST33501BU	3/4"	51.0	32.0	38.0	6
ST33502BU	13/16"	51.0	34.0	38.0	6
ST33503BU	7/8"	51.0	35.0	38.0	6
ST33504BU	15/16"	51.0	38.0	38.0	6
ST33505BU	1"	51.0	38.0	38.0	6
ST33506BU	1.1/16"	53.0	40.0	40.0	6
ST33507BU	1.1/8"	53.0	42.0	42.0	6
ST33508BU	1.3/16"	53.0	44.0	44.0	6
ST33509BU	1.1/4"	57.0	48.0	44.0	6
ST33510BU	1.5/16"	57.0	48.0	44.0	6
ST33511BU	1.3/8"	57.0	50.0	44.0	6
ST33512BU	1.7/16"	57.0	52.0	44.0	6
ST33513BU	1.1/2"	57.0	56.0	44.0	6
ST33514BU	1.9/16"	57.0	59.0	44.0	6
ST33515BU	1.5/8"	57.0	60.0	44.0	6

3/4" Drive 6 Point Deep Impact Socket

- Single hex (6 pt.) fastener end design
- For use with impact drivers
- Off-corner loading design reduces fastener rounding
- Deep socket to reach more fasteners
- Large markings offer easy size identification
- Black oxide finish to resist corrosion
- Chrome molybdenum alloy steel (Cr-Mo) for exceptional strength and durability
- Meets or exceeds ASME B107.110

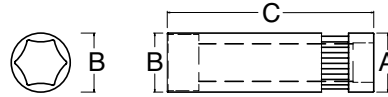

Article Code	Fastener Size	Overall Length (mm) (Dimension C)	Drive End (mm) (Dimension A)	Wrench End (mm) (Dimension B)	
ST34605SC	17.0 mm	90.0	44.0	30.0	1
ST34606SC	18.0 mm	90.0	44.0	31.0	1
ST34607SC	19.0 mm	90.0	44.0	33.0	1
ST34608SC	20.0 mm	90.0	44.0	34.0	1
ST34609SC	21.0 mm	90.0	44.0	35.0	1
ST34610SC	22.0 mm	90.0	44.0	37.0	1
ST34611SC	23.0 mm	90.0	44.0	38.0	1
ST34612SC	24.0 mm	90.0	44.0	39.0	1
ST34613SC	25.0 mm	90.0	44.0	40.0	1
ST34614SC	26.0 mm	90.0	44.0	41.0	1
ST34615SC	27.0 mm	90.0	44.0	43.0	1
ST34616SC	28.0 mm	90.0	44.0	44.0	1
ST34617SC	29.0 mm	90.0	44.0	45.0	1
ST34618SC	30.0 mm	90.0	44.0	46.0	1
ST34619SC	31.0 mm	90.0	44.0	48.0	1
ST34620SC	32.0 mm	90.0	44.0	49.0	1
ST34621SC	33.0 mm	90.0	44.0	51.0	1
ST34622SC	34.0 mm	90.0	44.0	51.0	1
ST34623SC	35.0 mm	90.0	44.0	53.0	1
ST34624SC	36.0 mm	90.0	44.0	54.0	1
ST34625SC	37.0 mm	90.0	44.0	55.0	1
ST34626SC	38.0 mm	90.0	44.0	56.0	1
ST34628SC	40.0 mm	90.0	44.0	59.0	1
ST34629SC	41.0 mm	90.0	44.0	60.0	1
SC34630	42.0 mm	90.0	44.0	61.0	1
SC34631	43.0 mm	90.0	44.0	63.0	1
SC34634	46.0 mm	90.0	44.0	66.0	1
SC34635	47.0 mm	90.0	44.0	68.0	1
SC34636	48.0 mm	90.0	44.0	69.0	1
SC34637	49.0 mm	90.0	44.0	70.0	1
SC34638	50.0 mm	90.0	54.0	71.0	1
SC34640	55.0 mm	90.0	54.0	78.0	1

1" Drive 6 Point Impact Socket

- Single hex (6 pt.) fastener end design
- For use with impact drivers
- Off-corner loading design reduces fastener rounding
- Large markings offer easy size identification
- Black oxide finish to resist corrosion
- Chrome molybdenum alloy steel (Cr-Mo) for exceptional strength and durability
- Meets or exceeds ASME B107.110

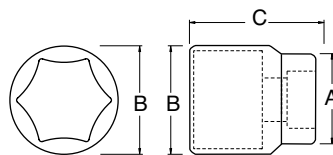

Article Code	Fastener Size	Overall Length (mm) (Dimension C)	Drive End (mm) (Dimension A)	Wrench End (mm) (Dimension B)	
ST34824SC	36.0 mm	66.0	54.0	56.5	4
ST34825SC	37.0 mm	66.0	54.0	58.0	4
ST34826SC	38.0 mm	66.0	54.0	59.0	4
ST34827SC	39.0 mm	66.0	54.0	60.0	4
ST34828SC	40.0 mm	66.0	54.0	61.0	4
ST34829SC	41.0 mm	68.0	54.0	62.5	4
ST34830SC	42.0 mm	68.0	54.0	64.0	4
ST34831SC	43.0 mm	70.0	54.0	65.0	4
ST34832SC	44.0 mm	70.0	54.0	66.0	4
ST34833SC	45.0 mm	70.0	54.0	67.5	4
ST34834SC	46.0 mm	72.0	54.0	69.0	4
ST34835SC	47.0 mm	72.0	54.0	70.0	4
ST34836SC	48.0 mm	76.0	54.0	71.5	4
ST34837SC	49.0 mm	76.0	54.0	73.0	4
ST34838SC	50.0 mm	76.0	54.0	74.0	4
ST34839SC	51.0 mm	76.0	54.0	75.0	2
ST34840SC	52.0 mm	80.0	54.0	76.5	2
ST34841SC	53.0 mm	80.0	54.0	78.0	2
ST34842SC	54.0 mm	80.0	54.0	79.0	2
ST34843SC	55.0 mm	84.0	54.0	80.0	2
ST34844SC	56.0 mm	84.0	54.0	81.5	2
ST34845SC	57.0 mm	84.0	54.0	82.5	2
ST34846SC	58.0 mm	84.0	54.0	84.0	1
ST34847SC	59.0 mm	88.0	54.0	85.0	1
ST34848SC	60.0 mm	88.0	54.0	86.5	1
ST34849SC	63.0 mm	88.0	54.0	90.0	1
ST34850SC	65.0 mm	92.0	54.0	92.5	1
ST34851SC	67.0 mm	92.0	54.0	95.0	1
ST34852SC	68.0 mm	96.0	54.0	96.5	1
ST34853SC	69.0 mm	96.0	54.0	98.0	1
ST33801BU	1.7/16"	66.0	54.0	56.5	4
ST33802BU	1.1/2"	66.0	54.0	59.0	4
ST33803BU	1.9/16"	66.0	54.0	61.0	4

Continued on next page

06 Impact Socket

Continued from previous page

Article Code	Fastener Size	Overall Length (mm) (Dimension C)	Drive End (mm) (Dimension A)	Wrench End (mm) (Dimension B)	
ST33804BU	1.5/8"	68.0	54.0	62.5	4
ST33805BU	1.11/16"	70.0	54.0	65.0	4
ST33806BU	1.3/4"	70.0	60.3	67.5	4
ST33807BU	1.13/16"	72.0	60.3	69.0	4
ST33808BU	1.7/8"	72.0	60.3	70.0	4
ST33809BU	1.15/16"	76.0	60.3	72.5	4
ST33810BU	2"	76.0	60.3	74.0	2
ST33811BU	2.1/16"	80.0	60.3	76.5	2
ST33812BU	2.1/8"	80.0	60.3	79.0	2
ST33813BU	2.3/16"	84.0	60.3	80.0	2
ST33814BU	2.1/4"	84.0	60.3	82.5	1
ST33815BU	2.5/16"	84.0	60.3	84.0	1
ST33816BU	2.3/8"	84.0	60.3	86.5	1
ST33817BU	2.7/16"	88.0	60.3	89.0	1
ST33818BU	2.1/2"	88.0	60.3	91.5	1
ST33819BU	2.9/16"	92.0	60.3	92.5	1
ST33820BU	2.5/8"	92.0	60.3	95.0	1
ST33821BU	2.11/16"	96.0	60.3	96.5	1
ST33822BU	2.3/4"	96.0	60.3	99.0	1

1" Drive 6 Point Deep Impact Socket

- Single hex (6 pt.) fastener end design
- For use with impact drivers
- Off-corner loading design reduces fastener rounding
- Deep socket to reach more fasteners
- Large markings offer easy size identification
- Black oxide finish to resist corrosion
- Chrome molybdenum alloy steel (Cr-Mo) for exceptional strength and durability
- Meets or exceeds ASME B107.110

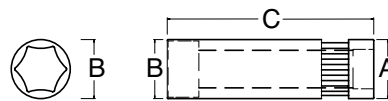

Article Code	Fastener Size	Overall Length (mm) (Dimension C)	Drive End (mm) (Dimension A)	Wrench End (mm) (Dimension B)	
ST34924SC	36.0 mm	90.0	54.0	57.0	1
ST34925SC	37.0 mm	90.0	54.0	58.0	1
ST34926SC	38.0 mm	90.0	54.0	59.0	1
ST34928SC	40.0 mm	90.0	54.0	62.0	1
ST34929SC	41.0 mm	90.0	54.0	63.0	1
ST34930SC	42.0 mm	90.0	54.0	64.0	1
ST34931SC	43.0 mm	90.0	54.0	66.0	1
ST34934SC	46.0 mm	100.0	54.0	69.0	1
ST34937SC	49.0 mm	100.0	54.0	73.0	1
ST34938SC	50.0 mm	100.0	54.0	74.0	1
ST34940SC	55.0 mm	100.0	54.0	81.0	1



Wrenches



6 Pc. Metric Combination Wrench Set 7 Pc. Metric Combination Wrench Set

Article Code	Content	
ST09018SJ	8, 10, 12, 13, 14, 15 mm	3



Article Code	Content	
ST09030	8, 10, 12, 14, 17, 19, 21 mm	4



07

7 Pc. Metric Combination Wrench Set 9 Pc. Metric Combination Wrench Set

Article Code	Content	
ST09070SJ	8, 10, 12, 13, 14, 17, 19 mm	12



Article Code	Content	
ST09020SJ	8, 10, 11, 12, 13, 14, 15, 17, 19 mm	3



2 PC. REVERSIBLE WRENCH RACK UP TO 13 OR 16 WRENCHES

ST95410
ST95411

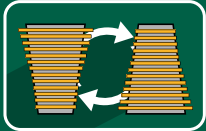

Holds metric or
SAE wrenches

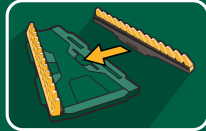

Adjustable
design



Reinforced
composite
construction



Self-aligning,
drop-in feature

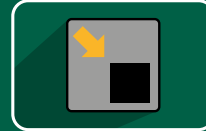

Space-saving
system

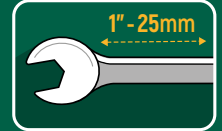

Fits up to 1"
or 25 mm

METRIC

SAE



2 Pc. Reversible Wrench Rack

- Reversible wrench rack holds metric or SAE wrenches
- Adjustable design takes up 30% less space, allowing you to conveniently store your wrenches
- Reinforced composite construction offers long-lasting durability
- Self-aligning , drop-in feature provides quick and easy access to your tools
- Space-saving system for compact storage in shallow drawers
- Fits up to 1" or 25 mm

 Excluded from Lifetime Warranty terms

Article Code	Description	
ST95410	For up to 13 Wrenches	24
ST95411	For up to 16 Wrenches	18



11 Pc. Metric Combination Wrench Set

Article Code	Content	
ST09064SJ	8, 9, 10, 11, 12, 13, 14, 17, 19, 21, 24 mm	12



11 Pc. Metric Combination Wrench Set

Article Code	Content	
ST09022SJ	8, 9, 10, 11, 12, 13, 14, 15, 17, 19, 22 mm	2



12 Pc. Metric Combination Wrench Set

Article Code	Content	
ST09063	6, 8, 10, 12, 13, 14, 17, 19, 22, 24, 30, 32 mm	12



12 Pc. Metric Combination Wrench Set

Article Code	Content	
ST08001SJ	6, 7, 8, 9, 10, 11, 12, 13, 14, 17, 19, 22 mm	12



14 Pc. Metric Combination Wrench Set

Article Code	Content	
ST09026SJ	8, 9, 10, 11, 12, 13, 14, 15, 16, 17, 18, 19, 22, 24 mm	3



14 Pc. Metric Combination Wrench Set

Article Code	Content	
ST09062-02	10, 11, 12, 13, 14, 16, 17, 19, 21, 22, 24, 27, 30, 32 mm	4



15 Pc. Metric Combination Wrench Set

Article Code	Content	
ST08002SJ	6, 7, 8, 9, 10, 11, 13, 14, 17, 19, 22, 24, 27, 30, 32 mm	4



17 Pc. Metric Offset Combination Wrench Set

Article Code	Content	
ST08018-02	6, 7, 8, 9, 10, 11, 12, 13, 14, 15, 16, 17, 18, 19, 20, 21, 22 mm	4



23 Pc. Metric Combination Wrench Set

Article Code	Content	
ST09027SJ	6, 7, 8, 9, 10, 11, 12, 13, 14, 15, 16, 17, 18, 19, 20, 21, 22, 23, 24, 25, 27, 30, 32 mm	4



26 Pc. Metric Combination Wrench Set

Article Code	Content	
ST09093	6, 7, 8, 9, 10, 11, 12, 13, 14, 15, 16, 17, 18, 19, 20, 21, 22, 23, 24, 25, 26, 27, 28, 29, 30, 32 mm	1



6 Pc. SAE Combination Wrench Set

Article Code	Content	
ST09017SJ	5/16, 3/8, 7/16, 1/2, 9/16, 5/8"	3



9 Pc. SAE Combination Wrench Set

Article Code	Content	
ST09019SJ	1/4, 5/16, 3/8, 7/16, 1/2, 9/16, 5/8, 11/16, 3/4"	3



11 Pc. SAE Combination Wrench Set

Article Code	Content	
ST09068SJ	3/8, 7/16, 1/2, 9/16, 5/8, 11/16, 3/4, 13/16, 7/8, 15/16, 1"	12



11 Pc. SAE Combination Wrench Set

Article Code	Content	
ST09021SJ	1/4, 5/16, 3/8, 7/16, 1/2, 9/16, 5/8, 11/16, 3/4, 13/16, 7/8"	2



14 Pc. SAE Combination Wrench Set

Article Code	Content	
ST09069SJ	3/8, 7/16, 1/2, 9/16, 5/8, 11/16, 3/4, 13/16, 7/8, 15/16, 1, 1-1/16, 1-1/8, 1-1/4"	4



16 Pc. SAE Combination Wrench Set

Article Code	Content	
ST09074SJ	1/4, 5/16, 3/8, 7/16, 1/2, 9/16, 5/8, 11/16, 3/4, 13/16, 7/8, 15/16, 1, 1-1/16, 1-1/8, 1-1/4"	4



Combination Wrench

- Combination wrenches feature open end & box end
- Off-corner loading design on box end provides better grip and reduces fastener rounding
- Combination wrenches feature a 15° offset box end for added knuckle clearance
- Sleek head design enables access to tight spots where a ratchet will not fit
- High-visibility stamped markings provide quick size identification
- Chrome vanadium alloy steel (Cr-V) for exceptional strength and durability
- Meets or exceeds ASME B107.100

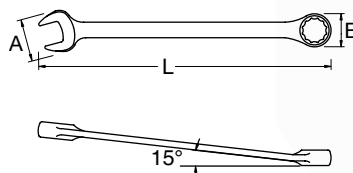

Article Code	Size	Length L (mm)	Width A (mm)	Width B (mm)	
ST40233SC	5.5 mm	127.0	13.0	11.4	6
ST40201SC	6.0 mm	127.0	13.0	11.4	6
ST40202SC	7.0 mm	133.0	14.4	12.3	6
ST40203SC	8.0 mm	140.0	16.5	13.6	6
ST40204SC	9.0 mm	149.0	18.5	15.0	6
ST40205SC	10.0 mm	159.0	20.5	16.0	6
ST40206SC	11.0 mm	165.0	22.5	17.5	6
ST40207SC	12.0 mm	171.0	25.0	18.5	6
ST40208SC	13.0 mm	177.0	27.0	20.0	6
ST40209SC	14.0 mm	190.0	19.0	21.5	6
ST40210SC	15.0 mm	199.0	31.0	22.5	6
ST40211SC	16.0 mm	208.0	33.0	24.0	6
ST40212SC	17.0 mm	225.0	35.0	26.0	6
ST40213SC	18.0 mm	237.0	37.0	26.6	6
ST40214SC	19.0 mm	248.0	39.0	28.0	6
ST40215SC	20.0 mm	265.0	42.0	30.0	4
ST40216SC	21.0 mm	271.0	43.0	31.0	4
ST40217SC	22.0 mm	293.0	45.3	32.0	4
ST40218SC	23.0 mm	304.0	47.5	33.0	4
ST40219SC	24.0 mm	316.0	49.0	34.0	4
ST40220SC	25.0 mm	335.0	51.0	37.5	4
ST40235SC	26.0 mm	348.0	54.0	37.5	4
ST40221SC	27.0 mm	359.0	55.0	39.0	4
ST40236SC	28.0 mm	402.0	62.5	42.6	2
ST40237SC	29.0 mm	402.0	62.5	42.6	2
ST40222SC	30.0 mm	415.0	65.0	43.0	2
ST40223SC	32.0 mm	426.0	66.5	46.0	2
ST40241SC	34.0 mm	476.0	71.0	50.0	2
ST40242SC	35.0 mm	476.0	71.0	50.0	2
ST40243SC	36.0 mm	501.0	79.0	55.5	2
ST40244SC	38.0 mm	501.0	79.0	55.5	2

Article Code	Size	Length L (mm)	Width A (mm)	Width B (mm)	
ST40245SC	41.0 mm	578.0	86.5	61.0	2
ST40246SC	42.0 mm	578.0	86.5	61.0	2
ST40248SC	46.0 mm	615.0	93.0	65.5	2
ST40249SC	48.0 mm	654.0	100.0	74.5	2
ST40250SC	50.0 mm	654.0	100.0	74.5	2
ST40251SC	55.0 mm	670.0	109.0	80.0	2
ST40252SC	60.0 mm	692.0	120.0	87.0	2
ST40101SC	1/4"	127.0	13.0	11.4	6
ST40102SC	5/16"	140.0	16.5	13.6	6
ST40103SC	3/8"	159.0	20.5	16.0	6
ST40104SC	7/16"	165.0	22.5	17.5	6
ST40105SC	1/2"	177.0	27.0	20.0	6
ST40106SC	9/16"	190.0	29.0	21.5	6
ST40107SC	5/8"	208.0	33.0	24.0	6
ST40108SC	11/16"	225.0	35.0	26.0	6
ST40109SC	3/4"	248.0	29.0	28.0	6
ST40110SC	13/16"	271.0	43.0	31.0	4
ST40111SC	7/8"	293.0	45.3	32.0	4
ST40112SC	15/16"	316.0	49.0	34.0	4
ST40113SC	1"	335.0	51.0	37.5	4
ST40114SC	1-1/16"	359.0	55.0	39.0	4
ST40115SC	1-1/8"	402.0	65.5	42.6	2
ST40116SC	1-1/4"	426.0	66.6	46.0	2
ST40117SC	1-5/16"	476.0	71.0	50.0	2
ST40118SC	1-3/8"	476.0	71.0	50.0	2
ST40119SC	1-7/16"	501.0	79.0	55.5	2
ST40120SC	1-1/2"	501.0	79.0	55.5	2
ST40121SC	1-5/8"	578.0	86.5	61.0	2
ST40122SC	1-3/4"	578.0	86.5	61.0	2
ST40123SC	1-7/8"	615.0	93.0	65.5	2
ST40124SC	2"	654.0	100.0	74.5	2

7 Pc. Metric XL X-Beam Combination Wrench Set

Article Code	Content	
ST08017	8, 10, 12, 13, 14, 17, 19 mm	4



10 Pc. Metric XL X-Beam Combination Wrench Set

Article Code	Content	
ST08006SJ	8, 10, 12, 13, 14, 15, 16, 17, 18, 19 mm	4



XL X-Beam Combination Wrench

- Combination wrenches feature open end & box end
- X-Beam™ design lets you apply force to the flat side of the wrench, reducing hand fatigue and increasing torque output by 25%
- Off-corner loading design on box end provides better grip and reduces fastener rounding
- Combination wrenches feature a 15° offset box end for added knuckle clearance
- Up to 25% longer for improved access and leverage
- Hand and wrench contact area increased 5 times when operating
- Sleek head design enables access to tight spots where a ratchet will not fit
- High-visibility stamped markings provide quick size identification
- Bright, full polish chrome finish easily wipes clean and resists corrosion
- Chrome vanadium alloy steel (Cr-V) for exceptional strength and durability
- Meets or exceeds ASME B107.100

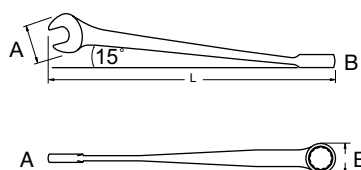

Article Code	Size	Length L (mm)	Width A (mm)	Width B (mm)	
ST40281SC	8.0 mm	147.0	18.5	13.6	6
ST40282SC	9.0 mm	158.0	20.5	15.0	6
ST40283SC	10.0 mm	166.0	23.2	16.1	6
ST40284SC	11.0 mm	185.0	25.5	17.4	6
ST40285SC	12.0 mm	196.0	27.5	18.5	6
ST40286SC	13.0 mm	206.0	28.5	19.8	6
ST40287SC	14.0 mm	222.0	32.5	21.5	6
ST40288SC	15.0 mm	232.0	33.5	22.6	6
ST40289SC	16.0 mm	242.0	35.5	24.0	6
ST40290SC	17.0 mm	260.0	38.5	26.0	6
ST40291SC	18.0 mm	269.0	39.0	26.6	6
ST40292SC	19.0 mm	278.7	42.5	28.0	6

7 Pc. Metric Double Open End Wrench Set

Article Code	Content	
ST09073SJ	6x7, 8x9, 10x11, 12x13, 14x15, 16x17, 19x21 mm	12



7 Pc. Metric Double Open End Wrench Set

Article Code	Content	
ST09071SJ	8x10, 10x12, 12x14, 14x17, 17x19, 21x23, 22x24 mm	12



8 Pc. Metric Double Open End Wrench Set

Article Code	Content	
ST08013	6x7, 8x9, 10x11, 12x13, 14x15, 16x17, 18x19, 21x22 mm	6



8 Pc. Metric Double Open End Wrench Set

Article Code	Content	
ST08014SJ	6x7, 8x9, 10x11, 12x13, 14x15, 16x17, 18x19, 20x22 mm	12



10 Pc. Metric Double Open End Wrench Set

Article Code	Content	
ST08010	5.5x7, 8x10, 9x11, 10x12, 12x14, 14x17, 17x19, 19x22, 24x27, 30x32 mm	2



10 Pc. Metric Double Open End Wrench Set

Article Code	Content	
ST08019-02	6x7, 8x9, 10x11, 12x13, 14x15, 16x17, 18x19, 21x23, 24x27, 30x32 mm	6



11 Pc. Metric Double Open End Wrench Set

Article Code	Content	
ST08041	6x7, 8x9, 10x11, 12x13, 14x15, 16x17, 18x19, 20x22, 21x23, 24x27, 30x32 mm	6



13 Pc. Metric Double Open End Wrench Set

Article Code	Content	
ST09029SJ	6x7, 8x10, 10x12, 11x13, 12x14, 14x17, 17x19, 19x21, 21x23, 22x24, 23x26, 24x27, 30x32 mm	4



Double Open End Wrench

- Double open end design with 2 sizes per wrench
- Sleek head design enables access to tight spots where a ratchet will not fit
- High-visibility stamped markings provide quick size identification
- Bright, full polish chrome finish easily wipes clean and resists corrosion
- Chrome vanadium alloy steel (Cr-V) for exceptional strength and durability
- Meets or exceeds ASME B107.100

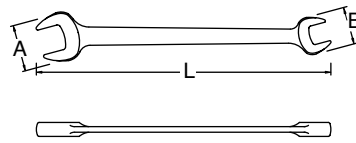

Article Code	Size	Length L (mm)	Width A (mm)	Width B (mm)	
ST41216SC	5.5x7 mm	124.0	16.5	12.5	6
ST41201SC	6x7 mm	124.0	16.5	12.5	6
ST41301SC	8x9 mm	137.0	18.8	16.7	6
ST41202SC	8x10 mm	150.0	20.8	16.5	6
ST41217SC	9x11 mm	150.0	23.0	20.8	6
ST41302SC	10x11 mm	150.0	23.0	20.8	6
ST41203SC	10x12 mm	163.0	25.0	20.8	6
ST41204SC	11x13 mm	175.0	27.0	23.0	6
ST41303SC	12x13 mm	163.0	27.2	24.6	6
ST41205SC	12x14 mm	187.0	29.0	25.0	6
ST41218SC	13x15 mm	182.0	33.4	27.0	6
ST41219SC	13x16 mm	182.0	33.4	27.0	6
ST41304SC	14x15 mm	182.0	33.4	29.0	6
ST41206SC	14x17 mm	201.0	35.5	29.0	6
ST41305SC	16x17 mm	201.0	35.5	33.4	6
ST41214SC	16x18 mm	201.0	35.5	33.4	6
ST41207SC	17x19 mm	228.0	39.7	35.5	6
ST41225ST	18x19 mm	228.0	39.7	35.5	4
ST41208SC	19x21 mm	240.0	43.8	39.7	4
ST41215SC	19x22 mm	254.0	46.0	43.8	4

Article Code	Size	Length L (mm)	Width A (mm)	Width B (mm)	
ST41227ST	20x22 mm	254.0	45.3	42.0	4
ST41226	21x22 mm	254.0	46.0	43.8	4
ST41209SC	21x23 mm	262.0	48.0	43.8	4
ST41210SC	22x24 mm	285.0	50.0	46.0	4
ST41211SC	23x26 mm	300.0	54.3	48.0	4
ST41212SC	24x27 mm	300.0	54.3	48.0	4
ST41220SC	27x30 mm	290.0	62.5	56.4	4
ST41213SC	30x32 mm	310.0	66.8	62.0	4
ST41221SC	30x34 mm	329.0	69.7	66.8	4
ST41222SC	32x34 mm	329.0	69.7	66.8	4
ST41223SC	34x36 mm	341.0	75.5	70.0	4
ST41101SC	1/4x5/16"	124.0	16.5	12.5	6
ST41102SC	3/8x7/16"	150.0	23.0	20.8	6
ST41103SC	1/2x9/16"	175.0	27.0	23.0	6
ST41104SC	5/8x11/16"	201.0	35.5	33.4	6
ST41105SC	11/16x3/4"	228.0	39.7	35.5	6
ST41106SC	13/16x7/8"	254.0	46.0	43.8	4
ST41107SC	15/16x1"	279.0	52.5	50.0	4
ST41108SC	1-1/8x1-1/4"	310.0	66.8	62.0	4

7 Pc. Metric Double Box End Wrench Set

Article Code	Content	
ST09072SJ	8x10, 10x12, 12x14, 14x17, 17x19, 21x23, 22x24 mm	12



8 Pc. Metric Double Box End Wrench Set

Article Code	Content	
ST08004SJ	6x7, 8x9, 10x11, 12x13, 14x15, 16x17, 17x19, 21x23 mm	12



10 Pc. Metric Double Box End Wrench Set

Article Code	Content	
ST08012	5.5x7, 8x10, 9x11, 10x12, 12x14, 14x17, 17x19, 19x22, 24x27, 30x32 mm	6



12 Pc. Metric Double Box End Wrench Set

Article Code	Content	
ST08007SJ	6x7, 8x9, 10x11, 12x13, 14x15, 16x17, 17x19, 19x22, 21x23, 22x24, 27x30, 30x32 mm	4



Double Box End Wrench

- Double box end wrench design with 2 sizes per wrench
- 40° offset double box end design provides better access to recessed fasteners
- Off-corner loading design on box ends provide better grip and reduces fastener rounding
- Sleek head design enables access to tight spots where a ratchet will not fit
- High-visibility stamped markings provide quick size identification
- Bright, full polish chrome finish easily wipes clean and resists corrosion
- Chrome vanadium alloy steel (Cr-V) for exceptional strength and durability
- Meets or exceeds ASME B107.100

Article Code	Size	Length L (mm)	Width A (mm)	Width B (mm)	
ST42221SC	5.5x7 mm	163.0	24.6	27.2	6
ST42213SC	6x7 mm	187.0	25.0	29.0	6
ST42214SC	8x9 mm	182.0	27.0	33.4	6
ST42201SC	8x10 mm	182.0	27.0	33.4	6
ST42222SC	9x11 mm	182.0	29.0	33.4	6
ST42215SC	10x11 mm	201.0	29.0	35.5	6
ST42202SC	10x12 mm	201.0	33.4	35.5	6
ST42203SC	11x13 mm	201.0	33.4	35.5	6
ST42216SC	12x13 mm	228.0	35.5	39.7	6
ST42204SC	12x14 mm	228.0	35.5	39.7	6
ST42223SC	13x15 mm	240.0	39.7	43.8	6
ST42224SC	13x16 mm	254.0	43.8	46.0	6
ST42217SC	14x15 mm	254.0	42.0	45.3	6
ST42205SC	14x17 mm	254.0	43.8	46.0	6
ST42218SC	16x17 mm	262.0	43.8	48.0	6
ST42219SC	16x18 mm	285.0	46.0	50.0	6
ST42206SC	17x19 mm	300.0	48.0	54.3	6
ST42207SC	19x21 mm	300.0	48.0	54.3	4
ST42220SC	19x22 mm	290.0	56.4	62.5	4

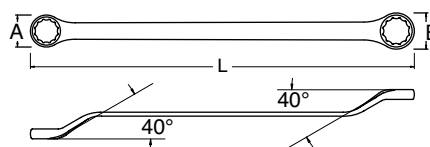

Article Code	Size	Length L (mm)	Width A (mm)	Width B (mm)	
ST42208SC	21x23 mm	310.0	62.0	66.8	4
ST42209SC	22x24 mm	329.0	66.8	69.7	4
ST42210SC	23x26 mm	329.0	66.8	69.7	4
ST42211SC	24x27 mm	341.0	70.0	75.5	4
ST42225SC	27x30 mm	124.0	12.5	16.5	4
ST42212SC	30x32 mm	150.0	20.8	23.0	4
ST42101SC	3/8x7/16"	175.0	23.0	27.0	6
ST42102SC	1/2x9/16"	201.0	33.4	35.5	6
ST42104SC	11/16x3/4"	228.0	35.5	39.7	6
ST42105SC	13/16x7/8"	254.0	43.8	46.0	4
ST42106SC	7/8x15/16"	279.0	50.0	52.5	4
ST42107SC	15/16x1"	310.0	62.0	66.8	4

11 Pc. Metric Deep Offset Double Box End Wrench Set

Article Code	Content	
ST08023	6x7, 8x9, 10x11, 12x13, 14x15, 16x17, 18x19, 20x22, 21x23, 24x27, 30x32 mm	6



Deep Offset Double Box End Wrench

- Double box end wrench design with 2 sizes per wrench
- 70° offset double box ends for better access to recessed fasteners
- Off-corner loading design on box ends provide better grip and reduces fastener rounding
- Sleek head design enables access to tight spots where a ratchet will not fit
- High-visibility stamped markings provide quick size identification
- Bright, full polish chrome finish easily wipes clean and resists corrosion
- Chrome vanadium alloy steel (Cr-V) for exceptional strength and durability
- Meets or exceeds ASME B107.100

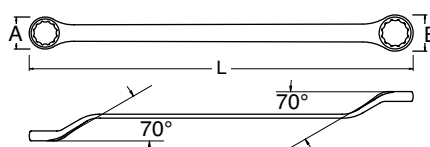

Article Code	Size	Length (mm)	Width (mm)	Hight (mm)	
ST42301	6x7 mm	10.7	11.2	170.0	16
ST42302	8x9 mm	11.8	13.3	183.0	16
ST42303	10x11 mm	14.7	16.1	195.0	16
ST42304	12x13 mm	17.9	19.1	213.0	16
ST42305	14x15 mm	20.6	21.5	225.0	12
ST42306	16x17 mm	23.6	24.6	245.0	12
ST42307	18x19 mm	26.3	27.3	265.0	12
ST42309	20x22 mm	28.8	31.8	288.0	12
ST42310	21x23 mm	30.1	34.1	305.0	12
ST42312	24x27 mm	34.6	38.1	325.0	6
ST42315	30x32 mm	42.7	45.7	370.0	6

6 Pc. Metric Flex Head Socket & Open Wrench Set

Article Code	Content	
ST09037SJ	10, 12, 13, 14, 17, 19 mm	6



3 Pc. Metric Double Flex Head Socket Wrench Set

Article Code	Content	
ST08042	8x10, 12x14, 17x19 mm	6



Double Flex Head Socket Wrench

- Double box end wrench design with 2 sizes per wrench
- 12 pt. socket end pivots 180° for better access to hard-to-reach fasteners
- Off-corner loading design on box ends provide better grip and reduces fastener rounding
- High-visibility stamped markings provide quick size identification
- Bright, full polish chrome finish easily wipes clean and resists corrosion
- Chrome vanadium alloy steel (Cr-V) for exceptional strength and durability
- Meets or exceeds ASME B107.100

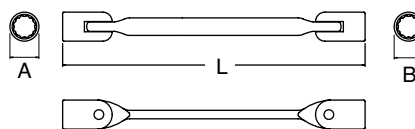

Article Code	Size	Length L (mm)	Width A (mm)	Width B (mm)	
ST47501ST	8x9 mm	183.0	12.7	14.0	6
ST47507ST	8x10 mm	189.0	13.7	14.8	6
ST47502ST	10x11 mm	197.0	14.7	15.8	6
ST47503ST	12x13 mm	211.0	16.2	17.4	6

Article Code	Size	Length L (mm)	Width A (mm)	Width B (mm)	
ST47504ST	14x15 mm	240.0	19.8	21.9	6
ST47505ST	16x17 mm	256.0	23.9	24.0	6
ST47509ST	17x19 mm	264.0	25.0	25.0	6
ST47506ST	18x19 mm	272.0	26.9	27.0	6

Box End Slugging Wrench

- Stubby beam length for when clearance is limited
- Off-corner loading design provides better grip and reduces fastener rounding
- Sleek head design enables access to tight spots where a ratchet will not fit
- Hammer striking surface on end for more force when tightening or loosening fasteners
- Features a safety through hole for connection to equipment via wire, string etc. in confined spaces
- High-visibility stamped markings provide quick size identification
- Heat treated for long lasting durability
- Meets or exceeds ASME B107.410

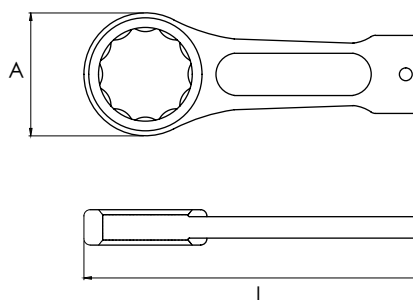

Article Code	Size	Length L (mm)	Width A (mm)	
ST48505	27.0 mm	175.0	45.0	4
ST48506	30.0 mm	185.0	50.0	4
ST48507	32.0 mm	195.0	55.0	4
ST48509	36.0 mm	200.0	55.0	4
SC48512	41.0 mm	222.0	62.0	4
ST48515	46.0 mm	240.0	75.0	4
ST48516	50.0 mm	245.0	75.0	3
ST48517	55.0 mm	265.0	85.0	2
ST48519	60.0 mm	270.0	90.0	2
ST48520	65.0 mm	270.0	90.0	2
ST48521	70.0 mm	320.0	105.0	2
SC48522	75.0 mm	330.0	110.0	1
SC48523	80.0 mm	359.0	131.0	1

Article Code	Size	Length L (mm)	Width A (mm)	
SC48524	85.0 mm	359.0	131.0	1
SC48525	90.0 mm	391.0	145.0	1
SC48526	95.0 mm	391.0	145.0	1
SC48527	100.0 mm	421.0	158.0	1
SC48528	105.0 mm	421.0	158.0	1
SC48529	110.0 mm	450.0	172.0	1
SC48530	115.0 mm	450.0	172.0	1
SC48531	120.0 mm	480.0	185.0	1

Open End Slugging Wrench

- Stubby beam length for when clearance is limited
- Sleek head design enables access to tight spots where a ratchet will not fit
- Hammer striking surface on end for more force when tightening or loosening fasteners
- Features a safety through hole for connection to equipment via wire, string, etc. in confined spaces
- High-visibility stamped markings provide quick size identification
- Heat treated for long lasting durability
- Meets or exceeds ASME B107.410

Article Code	Size	Length L (mm)	Width A (mm)	
SC48603	27.0 mm	175.0	55.0	6
SC48604	30.0 mm	185.0	60.0	6
SC48605	32.0 mm	190.0	65.0	6
SC48607	36.0 mm	210.0	70.0	6
SC48609	41.0 mm	230.0	85.0	6
SC48610	46.0 mm	240.0	95.0	6
SC48611	50.0 mm	270.0	100.0	6
SC48612	55.0 mm	295.0	115.0	6
SC48613	60.0 mm	310.0	120.0	3
SC48614	65.0 mm	330.0	145.0	3
SC48615	70.0 mm	365.0	150.0	3
SC48616	75.0 mm	390.0	156.0	1



Article Code	Size	Length L (mm)	Width A (mm)	
SC48617	80.0 mm	408.0	173.0	1
SC48618	85.0 mm	408.0	173.0	1
SC48619	90.0 mm	445.0	193.0	1
SC48620	95.0 mm	445.0	193.0	1
SC48621	100.0 mm	485.0	214.0	1
SC48622	105.0 mm	485.0	214.0	1

7 Pc. Stubby Combination Wrench Set

Article Code	Content	
ST09033SJ	10, 11, 12, 13, 14, 17, 19 mm	12



Stubby Combination Wrench

- Stubby beam length for when clearance is limited
- Combination wrenches feature open end & box end
- Off-corner loading design provides better grip and reduces fastener rounding
- Sleek head design enables access to tight spots where a ratchet will not fit
- High-visibility stamped markings provide quick size identification
- Bright, full polish chrome finish easily wipes clean and resists corrosion
- Chrome vanadium alloy steel (Cr-V) for exceptional strength and durability
- Meets or exceeds ASME B107.100

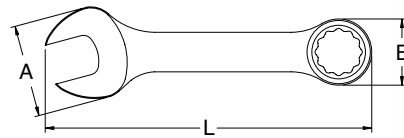

Article Code	Size	Length L (mm)	Width A (mm)	Width B (mm)	
SC49201	10.0 mm	95.5	20.5	16.0	6
ST49202BU	11.0 mm	103.0	22.6	17.5	6
SC49203	12.0 mm	106.5	24.6	18.5	6
SC49204	13.0 mm	108.5	26.7	20.0	6

Article Code	Size	Length L (mm)	Width A (mm)	Width B (mm)	
SC49205	14.0 mm	115.0	29.0	21.5	6
SC49208	17.0 mm	127.5	35.0	26.0	6
SC49210	19.0 mm	139.5	39.5	28.0	6

T-Handle 6 Point Socket Wrench

- T-Handle provides more leverage to break free stubborn fasteners
- Single hex (6 pt.) fastener end design
- 31 cm extension bar uniquely designed for working in a limited space
- 20 cm handle length ensures higher torque
- Chrome vanadium alloy steel (Cr-V) for exceptional strength and durability
- Meets or exceeds ASME B107.110



Article Code	Size	Length (mm)	
ST47701SC	8.0 mm	310.0	6
ST47702SC	9.0 mm	310.0	6
ST47703SC	10.0 mm	310.0	6
ST47704SC	11.0 mm	310.0	6
ST47705SC	12.0 mm	310.0	6

Article Code	Size	Length (mm)	
ST47706SC	13.0 mm	310.0	6
ST47707SC	14.0 mm	310.0	6
ST47710SC	17.0 mm	313.0	6
ST47712SC	19.0 mm	313.0	6

3 Pc. Metric Flare Nut Wrench Set

Article Code	Content	
ST09031SJ	9x11, 13x14, 16x17 mm	6



3 Pc. Metric Flare Nut Wrench Set

Article Code	Content	
ST09033U	9x10, 11x12, 13x14 mm	12



3 Pc. SAE Flare Nut Wrench Set

Article Code	Content	
ST09032	3/8x7/16", 1/2x9/16", 5/8x11/16"	6



Flare Nut Wrench

- Flare nut wrench design with 2 sizes per wrench
- Flare nut hex shaped heads give more points of contact on the fastener to prevent damage
- Rugged one piece steel alloy construction
- Use for removing or replacing nuts on fuel, brake lines, and air conditioning lines
- Sleek head design enables access to tight spots where a ratchet will not fit
- Bright, full polish chrome finish easily wipes clean and resists corrosion
- Meets or exceeds ASME B107.100



Article Code	Size	Length L (mm)	Width A (mm)	Width B (mm)	
ST48200SC	8x10 mm	140.0	17.3	21.0	6
ST48201SC	9x11 mm	152.0	19.4	22.2	6
ST48204SC	10x12 mm	166.0	21.0	23.4	6
ST48202SC	13x14 mm	178.0	24.9	26.1	6

Article Code	Size	Length L (mm)	Width A (mm)	Width B (mm)	
ST48203SC	16x17 mm	193.0	27.5	30.5	6
ST48301SC	3/8x7/16"	152.0	19.4	22.2	6
ST48302SC	1/2x9/16"	178.0	24.9	26.1	6
ST48303SC	5/8x11/16"	193.0	27.5	30.5	6

4 Pc. E-Torx® Box Wrench Set

Article Code	Content	
ST09012SJ	E6xE8, E10xE12, E14xE18, E20xE24	6



Double Box E-Torx® Wrench

- Double box end wrench design with 2 sizes per wrench
- Off-corner loading design on box ends provide better grip and reduces fastener rounding
- Sleek head design enables access to tight spots where a ratchet will not fit
- High-visibility stamped markings provide quick size identification
- Bright, full polish chrome finish easily wipes clean and resists corrosion
- Chrome vanadium alloy steel (Cr-V) for exceptional strength and durability

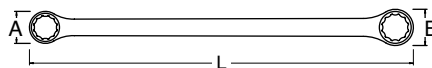

Article Code	Size	Length L (mm)	Width A (mm)	Width B (mm)	
ST45201SC	E6xE8	113.0	10.0	12.2	6
ST45202SC	E10xE12	141.0	13.5	15.5	6
ST45203SC	E14xE18	181.0	17.7	11.0	6
ST45204SC	E20xE24	225.0	25.0	28.6	6

VDE Insulated Open End Wrench

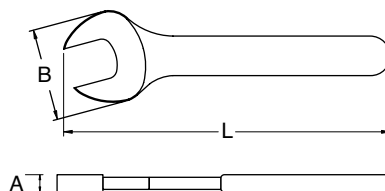

- VDE Certified
- For use in high voltage areas, up to 1000 V alternating current
- Sleek head design enables access to tight spots where a ratchet will not fit
- Red color for quick identification of VDE
- Chrome vanadium alloy steel (Cr-V) for exceptional strength and durability

Article Code	Size	Length L (mm)	Width B (mm)	Hight A (mm)	
ST41306SC	6.0 mm	90.0	23.0	7.0	6
ST41307SC	7.0 mm	90.0	25.0	7.0	6
ST41308SC	8.0 mm	100.0	27.0	7.5	6
ST41309SC	9.0 mm	100.0	29.0	7.5	6
ST41310SC	10.0 mm	110.0	31.0	8.0	6
ST41311SC	11.0 mm	110.0	34.0	8.5	6
ST41312SC	12.0 mm	130.0	36.0	8.5	6
ST41313SC	13.0 mm	135.0	39.0	10.5	6
ST41314SC	14.0 mm	145.0	40.0	10.5	6
ST41315SC	15.0 mm	150.0	42.0	11.5	6
ST41316SC	16.0 mm	160.0	43.0	11.5	6
ST41317SC	17.0 mm	160.0	47.0	12.5	6
ST41318SC	18.0 mm	175.0	50.0	13.0	6
ST41319SC	19.0 mm	175.0	53.0	14.0	6
ST41321SC	21.0 mm	195.0	55.0	14.0	6
ST41322SC	22.0 mm	195.0	58.0	14.0	6
ST41324SC	24.0 mm	225.0	62.0	16.5	6

VDE Insulated Single Offset Ring Wrench



- VDE Certified
- For use in high voltage areas, up to 1000 V alternating current
- Off-corner loading design provides better grip and reduces fastener rounding
- Offset box end design provides better access to recessed fasteners
- Red color for quick identification of VDE
- Chrome vanadium alloy steel (Cr-V) for exceptional strength and durability

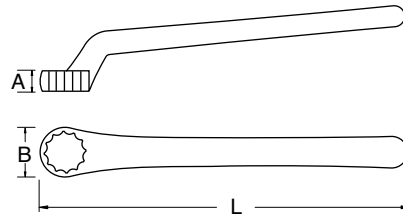

Article Code	Size	Length L (mm)	Width B (mm)	Hight A (mm)	
ST42406SC	6.0 mm	150.0	16.0	5.5	6
ST42407SC	7.0 mm	150.0	18.0	5.7	6
ST42408SC	8.0 mm	155.0	19.0	6.1	6
ST42409SC	9.0 mm	155.0	20.0	7.2	6
ST42410SC	10.0 mm	170.0	21.0	7.3	6
ST42411SC	11.0 mm	170.0	22.5	7.7	6
ST42412SC	12.0 mm	190.0	23.0	7.7	6
ST42413SC	13.0 mm	194.0	26.0	8.5	6
ST42414SC	14.0 mm	205.0	28.0	9.5	6
ST42415SC	15.0 mm	208.0	28.0	10.1	6
ST42416SC	16.0 mm	220.0	30.0	10.5	6
ST42417SC	17.0 mm	225.0	32.0	10.7	6
ST42418SC	18.0 mm	230.0	33.0	11.5	6
ST42419SC	19.0 mm	230.0	36.0	12.0	6
ST42421SC	21.0 mm	235.0	37.0	12.0	6
ST42422SC	22.0 mm	245.0	44.0	12.2	6
ST42424SC	24.0 mm	265.0	44.0	13.0	6

VDE Insulated Adjustable Wrench



- VDE Certified
- For use in high voltage areas, up to 1000 V alternating current
- Hex jaw design reduces slippage and tightly grips bolt
- Larger knurl provides a tighter fit, is easier to adjust and is less likely to bind up
- Built-in scale measures metric sizes for quick fastener identification
- Cushion handle for ease of use and slip protection
- Tempered steel construction offers strength and durability for long-lasting performance

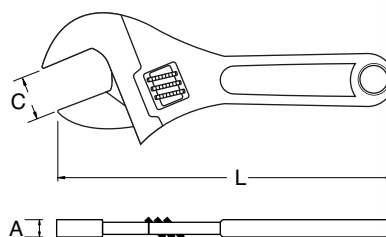

Article Code	Size	Length L (mm)	Jaw Capacity C (mm)	Head Thickness A (mm)	
ST47101SC	6"	163.0	24.0	11.6	6
ST47102SC	8"	215.0	28.2	11.7	6
ST47103SC	10"	260.0	36.6	16.4	6
ST47104SC	12"	312.0	38.0	20.4	6

11 Pc. X6 Pass-Thru Adjustable Wrench Set - Black Edition

Article Code	Content	
ST09000	1 - 8" Adjustable Wrenche 3-in-1 10 - Sockets Vortex 10 mm (3/8"), 11 mm (7/16"), 12 mm (15/32"), 13 mm (1/2"), 14 mm (9/16"), 15 mm (19/32"), 16 mm (5/8"), 17 mm (11/16"), 18 mm (23/32"), 19 mm (3/4")	6



11 PC. X6 PASS-THRU ADJUSTABLE WRENCH SET - BLACK EDITION

ST09000



Universal
socket style

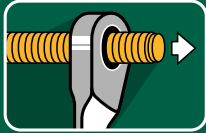

Pass-Through
system

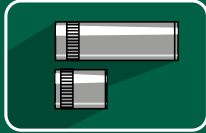

Standard and
deep socket
combined

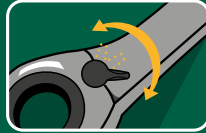

Flush mounted
reversing lever

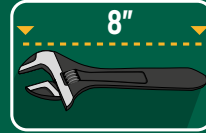

8" adjustable
wrench



Reversible
lower jaw



METRIC

SAE



Adjustable Wrench

- Wide jaw opening for greater capacity
- Wide handle for improved comfort and better leverage
- Hex jaw design reduces slippage and tightly grips bolt
- Larger knurl provides a tighter fit, is easier to adjust and is less likely to bind up
- Built-in scale measures metric sizes for quick fastener identification
- High-visibility stamped markings provide quick size identification
- Chrome vanadium alloy steel (Cr-V) for exceptional strength and durability
- Meets or exceeds ASME B107.100

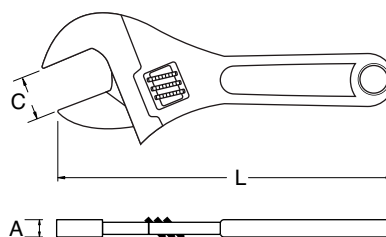

Article Code	Size	Length L (mm)	Jaw Capacity C (mm)	Head Thickness A (mm)	
ST47201SC	4"	100.0	12.7	9.4	6
ST47202SC	6"	150.0	23.8	11.0	6
ST47203SC	8"	200.0	28.5	12.6	6
ST47204SC	10"	250.0	33.3	15.7	6
ST47205SC	12"	300.0	38.1	19.0	4
ST47206SC	15"	375.0	42.8	23.9	3
ST47207SC	18"	450.0	52.4	28.5	1
ST47208SC	24"	600.0	61.9	34.5	1

2 Pc. Wide Jaw 6" and 10" Adjustable Wrench Set

Article Code	Content	
ST47130	Wide Jaw Adjustable Wrench 6", 10"	12



Wide Jaw Adjustable Wrench

- Extra wide jaw opening for greater capacity
- Wide handle for improved comfort and better leverage
- Hex jaw design reduces slippage and tightly grips bolt
- Larger knurl provides a tighter fit, is easier to adjust and is less likely to bind up
- Built-in scale measures in both SAE standard and metric sizes for quick fastener identification
- High-visibility stamped markings provide quick size identification
- Black oxide finish to resist corrosion
- Meets or exceeds ASME B107.100

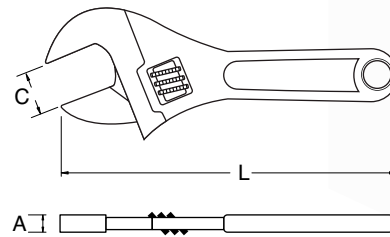

Article Code	Size	Length L (mm)	Jaw Capacity C (mm)	Head Thickness A (mm)	
ST47122	6"	150.0	28.6	11.0	6
ST47123	8"	200.0	35.9	13.2	6
ST47124	10"	250.0	39.0	15.5	6
ST47125	12"	300.0	43.0	19.0	4

Dipping Handle Adjustable Wrench

- Wide jaw opening for greater capacity
- Wide handle for improved comfort and better leverage
- Hex jaw design reduces slippage and tightly grips bolt
- Larger knurl provides a tighter fit, is easier to adjust and is less likely to bind up
- Built-in scale measures metric sizes for quick fastener identification
- Professional, ergonomic, oil resistant dipped grips wipe clean easily
- High-visibility size markings provide quick size identification
- Chrome vanadium alloy steel (Cr-V) for exceptional strength and durability
- Meets or exceeds ASME B107.100

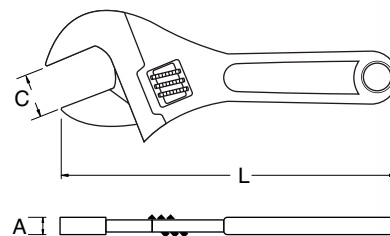

Article Code	Size	Length L (mm)	Jaw Capacity C (mm)	Head Thickness A (mm)	
ST47221SC	4"	100.0	12.7	8.6	6
ST47222SC	6"	150.0	23.8	9.5	6
ST47223SC	8"	200.0	28.5	12.0	6
ST47224SC	10"	250.0	33.3	14.0	6
ST47225SC	12"	300.0	38.1	16.5	4
ST47226SC	15"	375.0	42.8	21.0	3

Heavy Duty Pipe Wrench

- Forged jaw, featuring easing spinning adjusting nut
- Chrome vanadium alloy steel (Cr-V) for exceptional strength and durability



Article Code	Size	Length (mm)	Jaw Capacity (mm)	Head Thickness (mm)	
ST70812ST	8"	200.0	25.0	20.0	6
ST70813ST	10"	250.0	30.0	30.0	6
ST70814ST	12"	300.0	40.0	30.0	6
ST70815ST	14"	350.0	50.0	35.0	6
ST70816ST	18"	450.0	60.0	38.0	3
ST70817ST	24"	600.0	75.0	40.0	2
ST70818ST	36"	900.0	85.0	55.0	1
ST70819ST	48"	1200.0	110.0	70.0	1

Ratcheting Wrenches

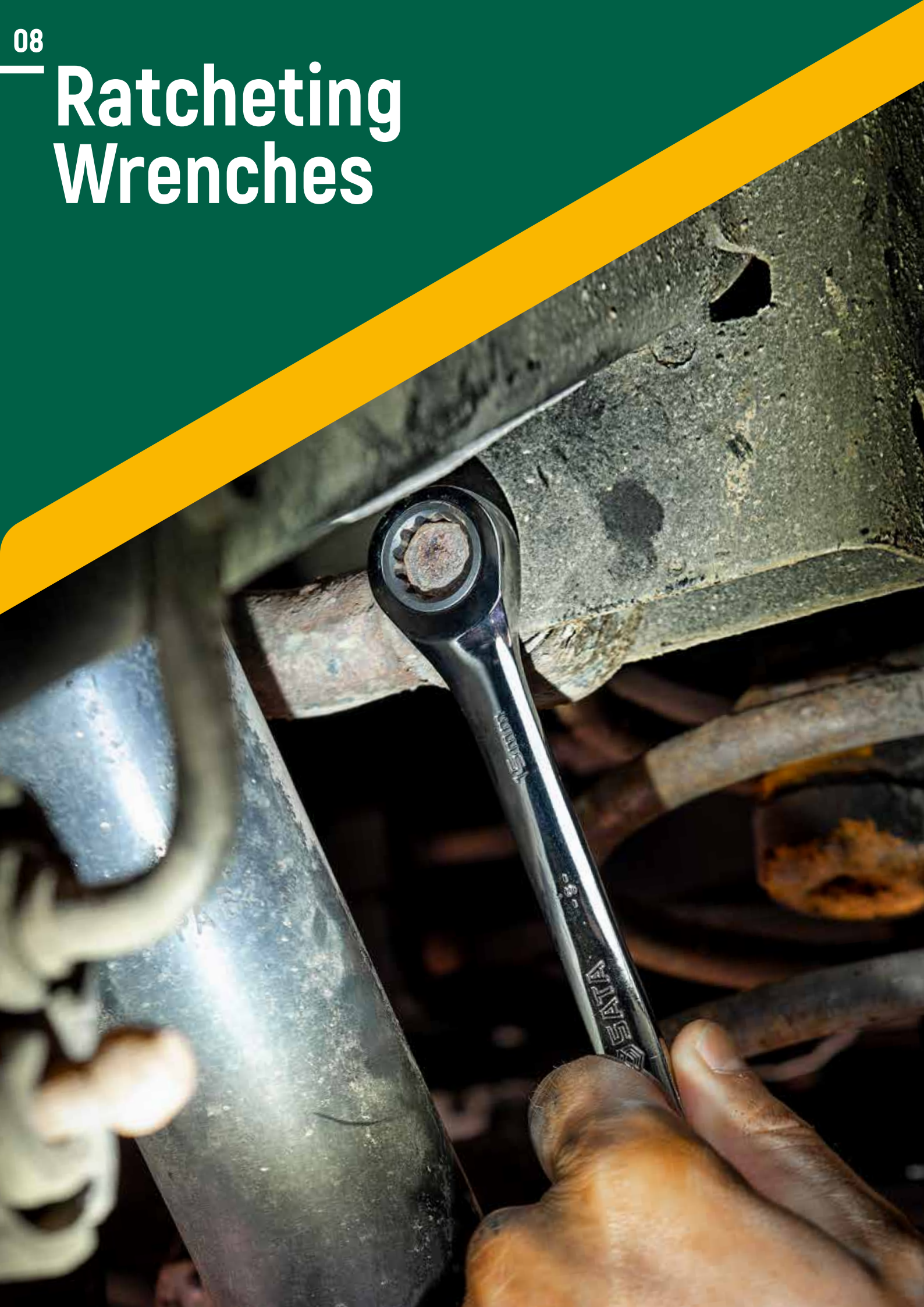

3 Pc. Metric Double Ratcheting Wrench Set

Article Code	Content	
ST09075	10, 13, 17 mm	10



5 Pc. Metric Combination Ratcheting Wrench Set

Article Code	Content	
ST09078SJ	10, 11, 12, 13, 14 mm	12



comes in a tool roll

7 Pc. Metric Double Ratcheting Wrench Set

Article Code	Content	
ST09024SJ	8, 10, 12, 13, 14, 15, 18 mm	6



8 Pc. Metric Double Ratcheting Wrench Set

Article Code	Content	
ST08007ASJ	8, 10, 12, 13, 14, 15, 17, 19 mm	3



12 PC. METRIC DOUBLE RATCHETING WRENCH SET

ST09066-02

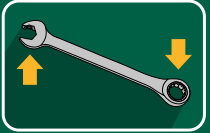

Ratcheting function on open end and box end



Needs as little as 5° to remove fasteners

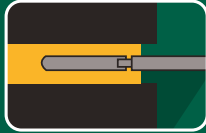

Head design enables access to tight spots



Open end quickly ratchet



Off-Corner loading design

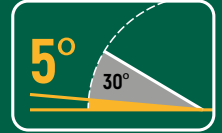

5° ratcheting arc versus 30°



METRIC

12



8 Pc. Metric Double Ratcheting Wrench Set

Article Code	Content	
ST09079SJ	8, 10, 11, 12, 13, 14, 17, 19 mm	5



12 Pc. Metric Double Ratcheting Wrench Set

Article Code	Content	
ST09066-02	8, 9, 10, 11, 12, 13, 14, 15, 16, 17, 18, 19 mm	2



7 Pc. SAE Double Ratcheting Wrench Set

Article Code	Content	
ST08020	5/16, 3/8, 7/16, 1/2, 9/16, 5/8, 3/4"	6



Double Ratcheting Wrench

- Ratcheting function on open end and box end
- Ratcheting box end needs as little as 5° to remove fasteners
- Sleek head design enables access to tight spots where a ratchet will not fit
- Open end quickly ratchet nuts and bolts without removing the wrench from the fastener
- Off-corner loading design on ratcheting box ends provide better grip and reduces fastener rounding
- 5° ratcheting arc versus 30° on standard combination wrenches
- High-visibility stamped markings provide quick size identification
- Bright, full polish chrome finish easily wipes clean and resists corrosion
- Chrome vanadium alloy steel (Cr-V) for exceptional strength and durability
- Meets or exceeds ASME B107.100

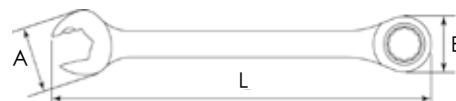

Article Code	Size	Length L (mm)	Width A (mm)	Width B (mm)	
ST43601	5.5 mm	126.0	15.0	17.8	6
ST43602	6.0 mm	126.0	15.0	17.8	6
ST43603	7.0 mm	133.0	17.0	17.8	6
ST43604	8.0 mm	140.0	20.0	19.0	5
ST43605	9.0 mm	150.0	20.3	19.7	5
ST43606	10.0 mm	159.0	22.5	21.4	5
ST43607	11.0 mm	165.5	25.0	23.0	5
ST43608	12.0 mm	172.0	27.4	24.5	5
ST43609	13.0 mm	178.0	30.0	26.5	3
ST43610	14.0 mm	191.0	32.0	28.6	3
ST43611	15.0 mm	200.0	34.5	30.0	3
ST43612	16.0 mm	209.0	35.0	32.0	3
ST43613	17.0 mm	226.0	38.5	33.5	3
ST43614	18.0 mm	237.0	40.5	34.6	3
ST43615	19.0 mm	248.0	43.0	37.0	3
ST43616	21.0 mm	292.0	46.0	42.0	4
ST43617	22.0 mm	292.0	46.0	42.0	4
ST43618	24.0 mm	334.0	52.5	49.0	4
ST43619	25.0 mm	334.0	52.5	49.0	4
ST43501	5/16"	140.0	20.0	19.0	5
ST43502	3/8"	159.0	22.5	21.4	5
ST43503	7/16"	165.5	25.0	23.0	5
ST43504	1/2"	178.0	30.0	26.5	3
ST43505	9/16"	191.0	32.0	28.6	3
ST43506	5/8"	209.0	35.0	32.0	3
ST43508	3/4"	248.0	43.0	37.0	3
ST43511	15/16"	334.0	52.2	49.0	4
ST43512	1"	334.0	52.2	49.0	4

7 PC. METRIC X6 OPEN END RATCHETING COMBINATION WRENCH SET - BLACK EDITION

ST47530

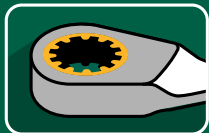

Universal spline drive



Open end quickly ratchet

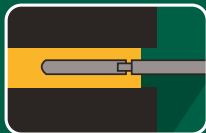

Head design enables access to tight spots



Off-Corner loading design

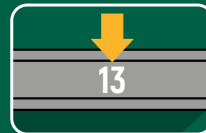

High-Visibility stamped markings



Black oxide finish



METRIC



7 Pc. Metric X6 Open End Ratcheting Combination Wrench Set - Black Edition

Article Code	Content	
ST47530	8, 10, 12, 13, 14, 15, 17 mm	3



7 Pc. Metric Stubby Combination Ratcheting Wrench Set

Article Code	Content	
ST09034	10, 12, 13, 14, 15, 17, 19 mm	3



7 Pc. Metric Combination Ratcheting Wrench Set

Article Code	Content	
ST09050SJ	8, 10, 12, 14, 17, 19, 22 mm	4



8 Pc. Metric Combination Ratcheting Wrench Set

Article Code	Content	
ST09038SJ	10, 11, 12, 13, 14, 15, 17, 19 mm	6



8 Pc. Metric Combination Ratcheting Wrench Set

Article Code	Content	
ST08008SJ	8, 10, 12, 13, 14, 15, 17, 19 mm	8



12 Pc. Metric Combination Ratcheting Wrench Set

Article Code	Content	
ST09040-02	8, 9, 10, 11, 12, 13, 14, 15, 16, 17, 18, 19 mm	4

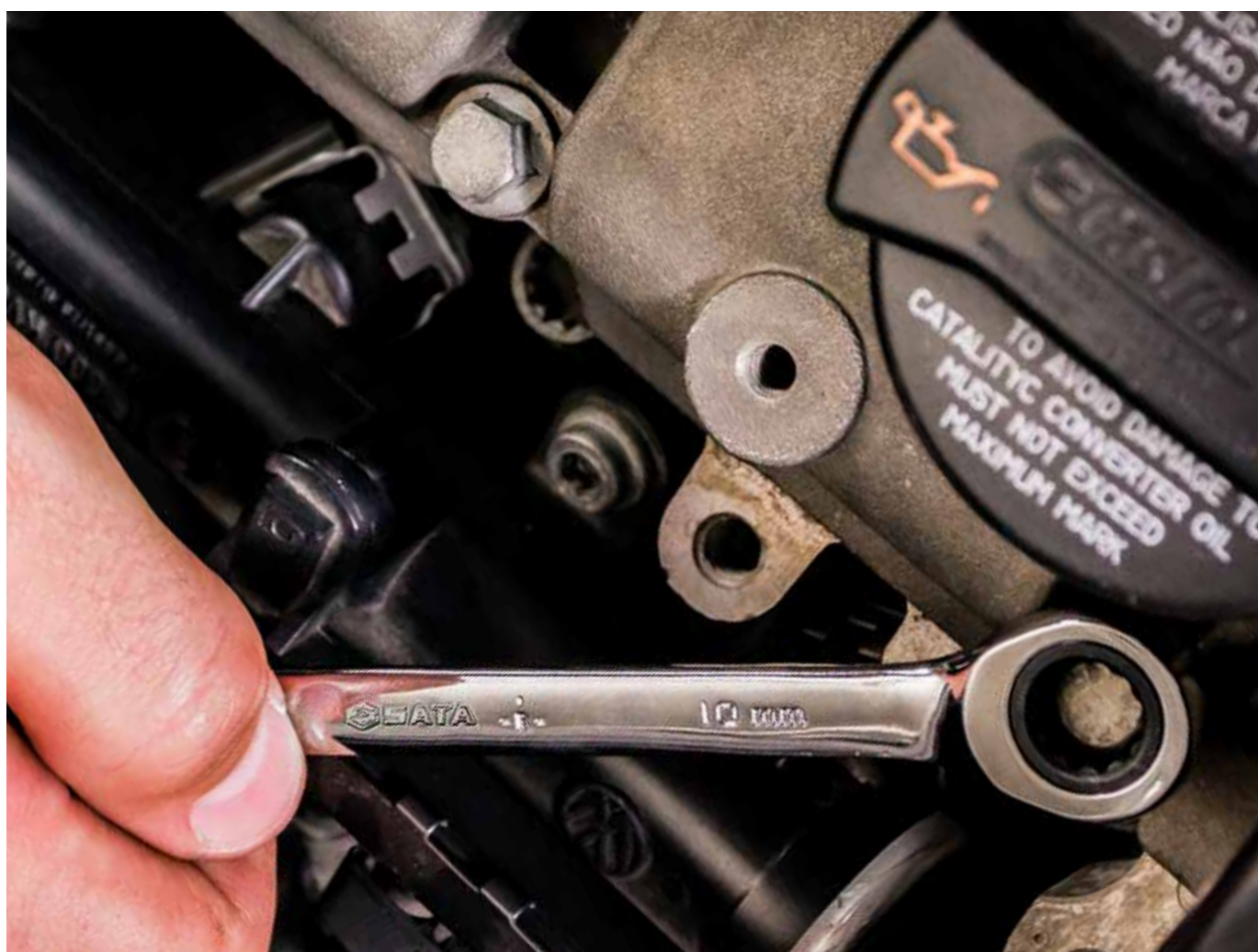

12 PC. METRIC COMBINATION RATCHETING WRENCH SET - BLACK EDITION

ST08032

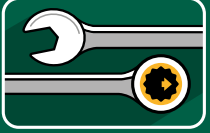

Open end & ratcheting box end



Needs as little as 5° to remove fasteners



Thin head and beam



Off-Corner loading design

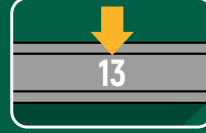

High-visibility stamped markings



Black oxide finish



METRIC

12



12 Pc. Metric Combination Ratcheting Wrench Set - Black Edition

Article Code	Content	
ST08032	8, 9, 10, 11, 12, 13, 14, 15, 16, 17, 18, 19 mm	8



7 Pc. Metric 120XP Combination Ratcheting Wrench Set

Article Code	Content	
ST08043U	8, 10, 12, 13, 14, 15, 18 mm	10



7 Pc. SAE 120XP Combination Ratcheting Wrench Set

Article Code	Content	
ST08044U	5/16, 3/8, 7/16, 1/2, 9/16, 5/8, 3/4"	10



7 Pc. SAE Combination Ratcheting Wrench Set

Article Code	Content	
ST09023SJ	5/16, 3/8, 7/16, 1/2, 9/16, 5/8, 3/4"	6



Combination Ratcheting Wrench

- Ratcheting Wrenches feature open end & ratcheting box end
- Ratcheting box end needs as little as 5° to remove fasteners
- Sleek head design enables access to tight spots where a ratchet will not fit
- Off-corner loading design on ratcheting box end provides better grip and reduces fastener rounding
- High-visibility stamped markings provide quick size identification
- Bright, full polish chrome finish easily wipes clean and resists corrosion
- Chrome vanadium alloy steel (Cr-V) for exceptional strength and durability
- Meets or exceeds ASME B107.100

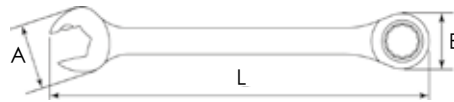

Article Code	Size	Length L (mm)	Width A (mm)	Width B (mm)	
ST43220ST	5.5 mm	126.0	15.0	17.8	6
ST43221ST	6.0 mm	126.0	15.0	17.8	6
ST43222ST	7.0 mm	133.0	17.0	17.8	6
ST43201ST	8.0 mm	140.0	20.0	19.0	6
ST43202ST	9.0 mm	150.0	20.3	19.7	6
ST43203ST	10.0 mm	159.0	22.5	21.4	6
ST43204ST	11.0 mm	165.5	25.0	23.0	6
ST43205ST	12.0 mm	172.0	27.4	24.5	6
ST43206ST	13.0 mm	178.0	30.0	26.5	6
ST43207ST	14.0 mm	191.0	32.0	28.6	6
ST43208ST	15.0 mm	200.0	34.5	30.0	6
ST43209ST	16.0 mm	209.0	35.0	32.0	6
ST43210ST	17.0 mm	226.0	38.5	33.5	6
ST43211ST	18.0 mm	237.0	40.5	34.6	6
ST43212ST	19.0 mm	248.0	43.0	37.0	6
ST43213ST	21.0 mm	292.0	46.0	42.0	4
ST43214ST	22.0 mm	292.0	46.0	42.0	4
ST43215ST	24.0 mm	334.0	52.5	49.0	4
ST43216ST	25.0 mm	334.0	52.5	49.0	4
ST43217ST	27.0 mm	359.0	56.4	52.5	4
ST43218ST	30.0 mm	402.0	62.0	58.5	2
ST43219ST	32.0 mm	426.0	65.6	62.0	2
ST43101ST	5/16"	140.0	20.0	19.0	6
ST43102ST	3/8"	159.0	22.5	21.4	6

Continued on next page

Article Code	Size	Length L (mm)	Width A (mm)	Width B (mm)	
ST43103ST	7/16"	165.5	25.0	23.0	6
ST43104ST	1/2"	178.0	30.0	26.5	6
ST43105ST	9/16"	191.0	32.0	28.6	6
ST43106ST	5/8"	209.0	35.0	32.0	6
ST43107ST	11/16"	226.0	38.5	33.5	6
ST43108ST	3/4"	248.0	43.0	37.0	6
ST43109ST	13/16"	292.0	46.0	42.0	4
ST43110ST	7/8"	292.0	46.0	42.0	4
ST43111ST	15/16"	334.0	52.2	49.0	4
ST43112ST	1"	334.0	52.2	49.0	4
ST43113ST	1-1/16"	359.0	56.4	52.5	4
ST43114ST	1-1/8"	402.0	62.0	58.5	2
ST43115ST	1-1/4"	426.0	65.6	62.0	2

4 Pc. Metric Double Box Ratcheting Wrench Set

Article Code	Content	
ST46135U	8x10, 12x13, 16x18, 17x19 mm	6



6 Pc. Metric Double Box Ratcheting Wrench Set

Article Code	Content	
ST09025SJ	8x9, 10x11, 12x13, 14x15, 16x18, 17x19 mm	6



Double Box Ratcheting Wrench

- Double box end wrench design with 2 sizes per wrench
- Ratcheting box end needs as little as 5° to remove fasteners
- Sleek head design enables access to tight spots where a ratchet will not fit
- Off-corner loading design on ratcheting box ends provide better grip and reduces fastener rounding
- High-visibility stamped markings provide quick size identification
- Bright, full polish chrome finish easily wipes clean and resists corrosion
- Chrome vanadium alloy steel (Cr-V) for exceptional strength and durability
- Meets or exceeds ASME B107.100

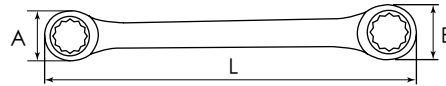

Article Code	Size	Length L (mm)	Width A (mm)	Width B (mm)	
ST46201ST	8x9 mm	131.0	18.0	19.5	6
ST46200ST	8x10 mm	131.0	18.5	21.8	6
ST46202ST	10x11 mm	151.0	21.8	23.5	6
ST46203ST	12x13 mm	171.0	25.0	26.5	6
ST46204ST	14x15 mm	191.0	28.5	30.5	6
ST46205ST	16x18 mm	211.0	32.5	35.5	6
ST46206ST	17x19 mm	231.0	34.5	36.6	6

8 Pc. Metric XL X-Beam Ratcheting Wrench Set

Article Code	Content	
ST08015SJ	8, 10, 12, 13, 14, 15, 17, 19 mm	4



10 Pc. Metric XL X-Beam Ratcheting Wrench Set

Article Code	Content	
ST08016	8, 10, 12, 13, 14, 15, 16, 17, 18, 19 mm	4



XL X-Beam™ Ratcheting Wrench

- Ratcheting Wrenches feature open end & ratcheting box end
- Ratcheting box end needs as little as 5° to remove fasteners
- X-Beam™ design lets you apply force to the flat side of the wrench, reducing hand fatigue and increasing torque output by 25%
- Sleek head design enables access to tight spots where a ratchet will not fit
- Off-corner loading design on ratcheting box ends provide better grip and reduces fastener rounding
- High-visibility stamped markings provide quick size identification
- Bright, full polish chrome finish easily wipes clean and resists corrosion
- Chrome vanadium alloy steel (Cr-V) for exceptional strength and durability
- Meets or exceeds ASME B107.100

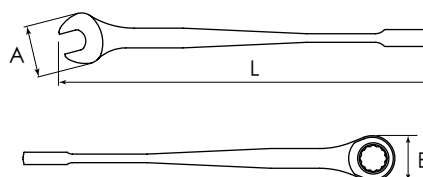

Article Code	Size	Length L (mm)	Width A (mm)	Width B (mm)	
ST46301	8.0 mm	151.0	20.0	18.5	6
ST46302	9.0 mm	165.0	20.3	19.6	6
ST46303ST	10.0 mm	181.0	22.7	22.0	6
ST46304ST	11.0 mm	196.0	25.0	24.0	6
ST46305ST	12.0 mm	207.8	27.0	25.3	6
ST46306ST	13.0 mm	220.8	29.0	27.4	6
ST46307ST	14.0 mm	235.8	32.0	29.0	6
ST46308ST	15.0 mm	250.0	34.0	31.3	6
ST46309	16.0 mm	261.0	35.0	33.3	6
ST46310ST	17.0 mm	276.0	38.5	35.0	6
ST46311	18.0 mm	290.0	40.5	36.0	6
ST46312ST	19.0 mm	306.0	42.0	37.0	6
ST46322	3/8"	181.0	22.7	22.0	6
ST46323	7/16"	196.0	25.0	24.0	6
ST46324	1/2"	220.0	29.0	27.4	6
ST46325	9/16"	235.0	32.0	29.0	6
ST46326	5/8"	261.0	35.0	33.3	6
ST46327	11/16"	276.0	38.5	35.0	6
ST46328	3/4"	306.0	42.0	37.0	6

5 Pc. Metric Reversible Ratcheting Wrench Set

Article Code	Content	
ST09083SJ	10, 11, 12, 13, 14 mm	12



6 Pc. Metric Reversible Ratcheting Wrench Set

Article Code	Content	
ST09080SJ	10, 12, 13, 14, 17, 19 mm	12



12 Pc. Metric Reversible Ratcheting Wrench Set

Article Code	Content	
ST08044	8, 9, 10, 11, 12, 13, 14, 15, 16, 17, 18, 19 mm	8



12 Pc. Metric Reversible Ratcheting Wrench Set - Black Edition

Article Code	Content	
ST08044B	8, 9, 10, 11, 12, 13, 14, 15, 16, 17, 18, 19 mm	8



12 PC. METRIC REVERSIBLE RATCHETING WRENCH SET - BLACK EDITION

ST08044B

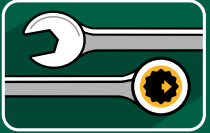

Open end & ratcheting box end



Needs as little as 5° to remove fasteners

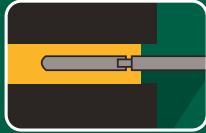

Head design enables access to tight spots



Off-Corner loading design

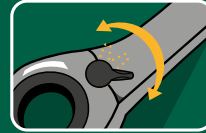

Flush mounted reversing lever

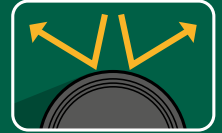

Black oxide finish



METRIC

12



Reversible Ratcheting Wrench

- Ratcheting Wrenches feature open end & ratcheting box end
- Ratcheting box end needs as little as 5° to remove fasteners
- Sleek head design enables access to tight spots where a ratchet will not fit
- Off-corner loading design on ratcheting box ends provide better grip and reduces fastener rounding
- Flush mounted reversing lever allows user to change direction without removing the wrench
- High-visibility stamped markings provide quick size identification
- Bright, full polish chrome finish easily wipes clean and resists corrosion
- Chrome vanadium alloy steel (Cr-V) for exceptional strength and durability
- Meets or exceeds ASME B107.100

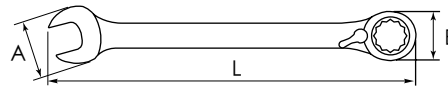

Article Code	Size	Length L (mm)	Width A (mm)	Width B (mm)	
ST46601ST	8.0 mm	140.0	20.0	18.0	6
ST46602ST	9.0 mm	150.0	20.0	19.6	6
ST46603ST	10.0 mm	159.0	22.5	21.6	6
ST46604ST	11.0 mm	165.0	25.0	23.5	6
ST46605ST	12.0 mm	172.0	27.0	25.0	6
ST46606ST	13.0 mm	178.0	30.0	27.0	6
ST46607ST	14.0 mm	191.0	32.0	28.5	6
ST46608ST	15.0 mm	200.0	34.5	31.0	6
ST46609ST	16.0 mm	208.0	35.0	33.0	6
ST46610ST	17.0 mm	226.0	38.5	34.5	6
ST46611ST	18.0 mm	236.0	41.0	36.0	6
ST46612ST	19.0 mm	248.0	42.0	37.0	6
ST46617	20.0 mm	292.0	46.0	42.0	4
ST46613	21.0 mm	292.0	46.0	42.0	4
ST46614	22.0 mm	292.0	46.0	42.0	4
ST46615	24.0 mm	334.0	52.0	49.0	4
ST46616	25.0 mm	334.0	52.0	49.0	4
ST46671BU	5/16"	140.0	20.0	18.0	6
ST46672BU	11/32"	150.0	20.0	19.6	6
ST46673BU	3/8"	159.0	22.5	21.6	6
ST46674BU	7/16"	165.0	25.0	23.5	6
ST46675BU	1/2"	178.0	30.0	27.0	6
ST46676BU	9/16"	191.0	32.0	28.5	6

Continued on next page

Article Code	Size	Length L (mm)	Width A (mm)	Width B (mm)	
ST46677BU	5/8"	208.0	35.0	33.0	6
ST46678BU	11/16"	226.0	38.5	34.5	6
ST46679BU	3/4"	248.0	42.0	37.0	4
ST46680BU	13/16"	292.0	46.0	42.0	4
ST46681BU	7/8"	292.0	46.0	42.0	4
ST46682BU	15/16"	334.0	52.0	49.0	4
ST46683BU	1"	334.0	52.0	49.0	4

5 Pc. Metric Flex Head Ratcheting Wrench Set

Article Code	Content	
ST09082SJ	10, 11, 12, 13, 14 mm	12



12 Pc. Metric Flex Head Ratcheting Wrench Set - Black Edition

Article Code	Content	
ST08033	8, 9, 10, 11, 12, 13, 14, 15, 16, 17, 18, 19 mm	8



12 PC. METRIC FLEX HEAD RATCHETING WRENCH SET - BLACK EDITION

ST08033

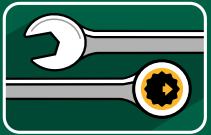

Open end & ratcheting box end



Needs as little as 5° to remove fasteners

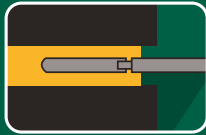

Head design enables access to tight spots

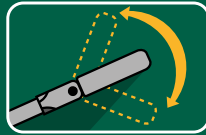

Flex head ratcheting box end



Off-Corner loading design

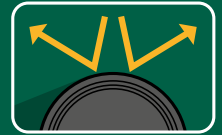

Black oxide finish



METRIC

12



Flex Head Ratcheting Wrench

- Ratcheting Wrenches feature open end & ratcheting box end
- Ratcheting box end needs as little as 5° to remove fasteners
- Sleek head design enables access to tight spots where a ratchet will not fit
- Flex head ratcheting box end provides access for hard to reach angled fasteners
- Off-corner loading design on ratcheting box ends provide better grip and reduces fastener rounding
- High-visibility stamped markings provide quick size identification
- Bright, full polish chrome finish easily wipes clean and resists corrosion
- Chrome vanadium alloy steel (Cr-V) for exceptional strength and durability
- Meets or exceeds ASME B107.100

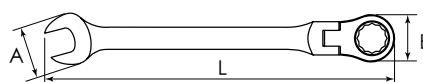

Article Code	Size	Length L (mm)	Width A (mm)	Width B (mm)	
ST46421	8.0 mm	144.0	20.0	18.5	6
ST46422	9.0 mm	152.0	20.0	20.0	6
ST46401ST	10.0 mm	161.0	22.5	22.0	6
ST46402ST	11.0 mm	168.0	25.0	24.0	6
ST46403ST	12.0 mm	174.0	27.0	25.0	6
ST46404ST	13.0 mm	181.0	30.0	27.4	6
ST46405ST	14.0 mm	193.0	32.0	28.8	6
ST46406ST	15.0 mm	202.0	34.5	30.8	6
ST46407ST	16.0 mm	210.0	35.0	33.0	6
ST46408ST	17.0 mm	227.0	38.5	35.0	6
ST46409ST	18.0 mm	238.0	41.0	36.0	6
ST46410ST	19.0 mm	249.0	42.0	36.9	6
ST46412	21.0 mm	292.0	46.0	42.0	4
ST46413ST	22.0 mm	292.0	46.0	42.0	4
ST46414	24.0 mm	334.0	52.5	49.0	4
ST46415	25.0 mm	334.0	52.5	49.0	4
ST46471BU	5/16"	144.0	20.0	18.5	6
ST46473BU	7/16"	168.0	25.0	24.0	6
ST46476BU	5/8"	210.0	35.0	33.0	6
ST46477BU	11/16"	227.0	38.5	35.0	6
ST46478BU	3/4"	249.0	42.0	36.9	6
ST46479BU	13/16"	292.0	46.0	42.0	4
ST46480BU	7/8"	292.0	46.0	42.0	4
ST46481BU	15/16"	334.0	52.5	49.0	4
ST46482BU	1"	334.0	52.5	49.0	4

7 Pc. Metric XL Locking Flex Head Ratcheting Wrench Set

Article Code	Content	
ST09043SJ	10, 12, 13, 14, 15, 17, 19 mm	3



XL Locking Flex Head Ratcheting Wrench

- Ratcheting Wrenches feature open end & ratcheting box end
- Ratcheting box end needs as little as 5° to remove fasteners
- Sleek head design enables access to tight spots where a ratchet will not fit
- Flex head ratcheting box end provides access for hard to reach angled fasteners
- Off-corner loading design on ratcheting box ends provide better grip and reduces fastener rounding
- One finger operated lever with options of "locking" or "not locking" positions
- High-visibility stamped markings provide quick size identification
- Bright, full polish chrome finish easily wipes clean and resists corrosion
- Chrome vanadium alloy steel (Cr-V) for exceptional strength and durability
- Meets or exceeds ASME B107.100

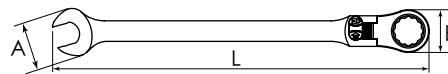

Article Code	Size	Length L (mm)	Width A (mm)	Width B (mm)	
ST46801ST	8.0 mm	146.0	16.9	17.9	6
ST46802ST	9.0 mm	159.0	18.8	19.6	6
ST46803ST	10.0 mm	171.0	20.9	21.3	6
ST46804ST	11.0 mm	183.0	23.1	23.0	6
ST46805ST	12.0 mm	195.0	25.0	24.1	6
ST46806ST	13.0 mm	207.0	27.1	26.2	6
ST46807ST	14.0 mm	219.0	29.3	26.7	6
ST46808ST	15.0 mm	231.0	31.2	29.9	6
ST46809ST	16.0 mm	242.0	33.2	31.7	6
ST46810ST	17.0 mm	254.0	35.5	32.2	6
ST46811ST	18.0 mm	267.0	37.5	33.3	6

Continued on next page

Article Code	Size	Length L (mm)	Width A (mm)	Width B (mm)	
ST46812ST	19.0 mm	280.0	39.8	36.0	6
ST46813ST	20.0 mm	297.0	45.9	42.0	6
ST46814ST	21.0 mm	316.0	45.9	42.0	6
ST46815ST	22.0 mm	335.0	48.4	42.0	6
ST46816ST	24.0 mm	356.0	51.9	49.0	6
ST46817ST	25.0 mm	378.0	53.9	49.0	6
ST46902	11/32"	159.0	18.8	19.6	6
ST46904	7/16"	183.0	23.1	23.0	6
ST46905	1/2"	207.0	27.1	26.2	6
ST46906	9/16"	219.0	29.3	26.7	6
ST46909	3/4"	280.0	39.8	36.0	6
ST46911	7/8"	335.0	48.4	42.0	6
ST46912	15/16"	345.0	52.4	42.0	6

Construction Ratcheting Wrench

- Construction Ratcheting Wrench design with 2 sizes per wrench
- Designed with ratcheting function for increased speed and efficiency while fastening
- Tip end can be used to twist wire
- Composite function of socket and ratchet
- High-visibility stamped markings provide quick size identification
- Black oxide finish to resist corrosion
- Chrome vanadium alloy steel (Cr-V) for exceptional strength and durability
- Meets or exceeds ASME B107.100

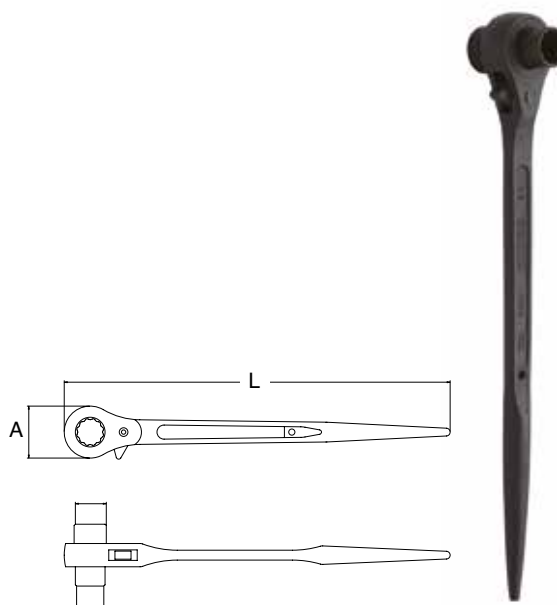

Article Code	Size	Length L (mm)	Width A (mm)	
SC47305	12 x 14 mm	225.0	31.0	2
SC47308	14 x 17 mm	270.0	35.0	2
SC47309	17 x 19 mm	305.0	42.0	2
SC47310	17 x 21 mm	310.0	40.0	2
SC47312	19 x 21 mm	310.0	40.0	2
SC47313	19 x 22 mm	310.0	40.0	2
SC47314	19 x 24 mm	310.0	45.0	2
SC47317	21 x 26 mm	370.0	54.0	2
SC47319	22 x 24 mm	370.0	55.0	2
SC47321	24 x 27 mm	400.0	65.0	2
SC47322	24 x 30 mm	400.0	60.0	2
SC47324	30 x 32 mm	400.0	60.0	2
SC47325	32 x 36 mm	400.0	65.0	2

Ratcheting Adjustable Wrench 8"

- Adjustable wrench for versatility
- Ratcheting function increases speed when tightening and loosening fasteners
- Wide handle for improved comfort and better leverage
- Hex jaw design reduces slippage and tightly grips bolt
- Larger knurl provides a tighter fit, is easier to adjust and is less likely to bind up
- Built-in scale measures metric sizes for quick fastener identification
- Meets or exceeds ASME B107.100

 Excluded from Lifetime Warranty terms



Article Code	Size	Length L (mm)	Jaw Capacity (mm)	Head Thickness (mm)	
ST47403	8"	215.2	25.0	14.5	6

3 Pc. Metric Drive Adapter Set

Article Code	Content	
ST09084SJ	1/4" Dr. x10 mm, 3/8" Dr. x13 mm, 1/2" Dr. x19 mm	10



1/4" Metric Ratcheting Wrench Socket Adapter Quick Release Function

- Converts a 10 mm box end ratcheting wrench into a 1/4" drive tool
- Pin hole can be used with detent pin for secure socket retention to the adapter
- Bright, full polish chrome finish easily wipes clean and resists corrosion
- Chrome vanadium alloy steel (Cr-V) for exceptional strength and durability



Article Code	Overall Length (mm)	
ST46654ST	20.3	10

3/8" Metric Ratcheting Wrench Socket Adapter with Quick Release Function

- Converts a 13 mm box end ratcheting wrench into a 3/8" drive tool
- Pin hole can be used with detent pin for secure socket retention to the adapter
- Bright, full polish chrome finish easily wipes clean and resists corrosion
- Chrome vanadium alloy steel (Cr-V) for exceptional strength and durability



Article Code	Overall Length (mm)	
ST46655ST	24.3	10

1/2" Metric Ratcheting Wrench Socket Adapter with Quick Release Function

- Converts a 19 mm box end ratcheting wrench into a 1/2" drive tool
- Pin hole can be used with detent pin for secure socket retention to the adapter
- Bright, full polish chrome finish easily wipes clean and resists corrosion
- Chrome vanadium alloy steel (Cr-V) for exceptional strength and durability



Article Code	Overall Length (mm)	
ST46656ST	29.3	10

Torque Wrenches



A-Series Mechanical Torque Wrench

- Teardrop, low-profile head and flush-mounted on/off switch allow better access in tight spaces
- High accuracy with deviation of +/- 3% max.
- Knurled grip for comfort and control
- Flush mounted reversing lever allows user to change direction with one hand without removing the wrench
- Audible click and/or impulse when torque setting is reached
- Detent style locking collar prevents accidental change of torque setting
- Matt finish
- Tempered steel construction offers strength and durability for long-lasting performance
- High strength protective case
- Meets or exceeds ASME B107.300



Article Code	Size	Overall Length (mm)	Primary Scale Range (Nm)	Max. Torque (Nm)	
ST96211SC	1/4"	228.0	1.0	5.0	4
ST96212SC	3/8"	268.0	5.0	25.0	4
ST96311SC	1/2"	472.0	20.0	100.0	4
ST96312SC	1/2"	555.0	40.0	200.0	2
ST96313SC	1/2"	616.0	68.0	340.0	2
ST96411SC	3/4"	864.0	110.0	550.0	1
ST96412SC	3/4"	1107.0	160.0	800.0	1



Torque wrench is a precision instrument. Warranty conditions:
SATA torque products are warrantee to
(1) be free of defects in material and workmanship.
(2) Accuracy standards for calibration are warrantee for 90 days from date of purchase. Products for which warranty repair is requested should be returned, at buyer's cost, to your nearest repair center.

SATA torque products are precision instruments that contain moving parts. These components are subject to normal wear through use, and replacement there of is the responsibility of the buyer. Torque products should be routinely checked for calibration at an authorized repair center using SATA repair parts.

This warranty shall not apply to products which have been misused, abused, damaged by accident or otherwise, repaired by anyone other than an authorized repair center or modified by anyone other than SATA tools.

Pliers & Crimping Tools



3 Pc. VDE Insulated Pliers Set



Article Code	Content	
ST09261SJ	1 - 8" VDE Insulated Linesman Pliers 1 - 6" VDE Insulated Diagonal Pliers 1 - 6" VDE Insulated Long Nose Pliers	6



3 Pc. Pliers Set

Article Code	Content	
ST70002U	1 - 8" Universal Pliers 1 - 8" Long Nose Pliers 1 - 7" Diagonal Pliers	6



5 Pc. Pliers Set

Article Code	Content	
ST70001U	2 - Tongue-and-Groove Pliers, 10", 12" 1 - Long Nose Pliers 8" 1 - Diagonal Pliers 7" 1 - Slip-Joint Pliers 6"	5



Long Nose Pliers

- TPE two-tone anti-slip handle provides superior comfort and grip
- Serrated jaws for precision gripping in restricted areas
- Laser hardened cutting edges cut clean and remain sharp 50% longer
- Clear anti-rust coating prolongs tool life
- Manufactured from chrome-nickel steel for better strength and longer tool life
- Meets or exceeds ASME B107.500



Article Code	Size	Overall Length (mm)	Jaw Thickness (mm)	Jaw Width (mm)	Overall Width (mm)	Cutting Capacity (mm)	
ST70101AST	6"	165.0	10.0	20.0	57.0	Copper Wire Ø 2.2, Iron Wire Ø 2.0, Hard Wire Ø 1.6	6
ST70102AST	8"	207.0	12.0	22.8	57.0	Copper Wire Ø 2.6, Iron Wire Ø 2.4, Hard Wire Ø 2.0	6

High Leverage Long-Nose Pliers

- High leverage joint design provides greater cutting power while reducing effort to make cuts
- TPE two-tone anti-slip handle provides superior comfort and grip
- Serrated jaws for precision gripping in restricted areas
- Laser hardened cutting edges cut clean and remain sharp 50% longer
- Clear anti-rust coating prolongs tool life
- Manufactured from chrome-nickel steel for better strength and longer tool life
- Meets or exceeds ASME B107.500



Article Code	Size	Overall Length (mm)	Jaw Thickness (mm)	Jaw Width (mm)	Overall Width (mm)	Cutting Capacity (mm)	
ST72401	6"	164.4	10.0	20.0	57.6	Copper Wire Ø 2.2, Iron Wire Ø 2.0, Hard Wire Ø 1.6	6

VDE Insulated Long Nose Pliers



- VDE Certified
- For use in high voltage areas, up to 1000 V alternating current
- Serrated jaws for precision gripping in restricted areas
- Induction hardened with angled teeth grip flat, curved, square or hexagonal objects
- Anti-slip handle provides superior comfort and grip
- Clear anti-rust coating prolongs tool life
- Heat treated for long lasting durability
- Chrome vanadium alloy steel (Cr-V) for exceptional strength and durability
- Meets or exceeds ASME B107.13M



Article Code	Size	Overall Length (mm)	Jaw Thickness (mm)	Jaw Width (mm)	Overall Width (mm)	Cutting Capacity (mm)	
ST70131ST	6"	170.0	9.0	15.5	56.0	Medium Hard Wire Ø 1.6	6
ST70132ST	8"	212.0	9.0	16.5	58.6	Medium Hard Wire Ø 1.6	6

Diagonal Pliers

- TPE two-tone anti-slip handle provides superior comfort and grip
- Laser hardened cutting edges cut clean and remain sharp 50% longer
- Clear anti-rust coating prolongs tool life
- Manufactured from chrome-nickel steel for better strength and longer tool life
- Meets or exceeds ASME B107.500



Article Code	Size	Overall Length (mm)	Jaw Thickness (mm)	Jaw Width (mm)	Overall Width (mm)	Cutting Capacity (mm)	
ST70201AST	5"	131.0	9.8	17.0	54.0	Copper Wire Ø 2.2, Iron Wire Ø 2.0, Hard Wire Ø 1.6	6
ST70202AST	6"	161.0	11.2	18.5	57.0	Copper Wire Ø 2.6, Iron Wire Ø 2.4, Hard Wire Ø 2.0	6
ST70203AST	7"	187.0	13.8	30.0	57.0	Copper Wire Ø 2.6, Iron Wire Ø 2.4, Hard Wire Ø 2.0	6

High Leverage Diagonal Pliers

- High leverage joint design provides greater cutting power while reducing effort to make cuts
- TPE two-tone anti-slip handle provides superior comfort and grip
- Laser hardened cutting edges cut clean and remain sharp 50% longer
- Clear anti-rust coating prolongs tool life
- Manufactured from chrome-nickel steel for better strength and longer tool life
- Meets or exceeds ASME B107.500



Article Code	Size	Overall Length (mm)	Jaw Thickness (mm)	Jaw Width (mm)	Overall Width (mm)	Cutting Capacity (mm)	
ST72302B-02	7"	190.0	13.8	30.0	60.0	Copper Wire Ø 2.6, Iron Wire Ø 2.4, Hard Wire Ø 2.0	6

VDE Insulated Diagonal Pliers



- VDE Certified
- For use in high voltage areas, up to 1000 V alternating current
- Laser hardened cutting edges cut clean and remain sharp 50% longer
- Anti-slip handle provides superior comfort and grip
- Clear anti-rust coating prolongs tool life
- Heat treated for long lasting durability
- Chrome vanadium alloy steel (Cr-V) for exceptional strength and durability
- Meets or exceeds ASME B107.11M



Article Code	Size	Overall Length (mm)	Jaw Thickness (mm)	Jaw Width (mm)	Overall Width (mm)	Cutting Capacity (mm)	
ST70232ST	6"	170.0	11.5	21.0	59.0	Medium Hard Wire Ø 1.6	6
ST70233ST	7"	191.0	12.5	30.0	68.0	Medium Hard Wire Ø 2.0	6

Linesman Pliers

- TPE two-tone anti-slip handle provides superior comfort and grip
- Laser hardened cutting edges cut clean and remain sharp 50% longer
- Clear anti-rust coating prolongs tool life
- Manufactured from chrome-nickel steel for better strength and longer tool life
- Meets or exceeds ASME B107.500



Article Code	Size	Overall Length (mm)	Jaw Thickness (mm)	Jaw Width (mm)	Overall Width (mm)	Cutting Capacity (mm)	
ST70301AST	6"	154.0	10.0	23.5	52.0	Copper Wire Ø 2.6, Iron Wire Ø 2.4, Hard Wire Ø 2.0	6
ST70302AST	7"	177.0	10.5	25.0	55.0	Copper Wire Ø 2.6, Iron Wire Ø 2.4, Hard Wire Ø 2.0	6
ST70303AST	8"	208.0	11.5	28.5	55.0	Copper Wire Ø 2.6, Iron Wire Ø 2.5, Hard Wire Ø 2.0	6

VDE Insulated Linesman Pliers



- VDE Certified
- For use in high voltage areas, up to 1000 V alternating current
- Anti-slip handle provides superior comfort and grip
- Induction hardened with angled teeth grip flat, curved, square or hexagonal objects
- Laser hardened cutting edges cut clean and remain sharp 50% longer
- Clear anti-rust coating prolongs tool life
- Heat treated for long lasting durability
- Chrome vanadium alloy steel (Cr-V) for exceptional strength and durability
- Meets or exceeds ASME B107.20M



Article Code	Size	Overall Length (mm)	Jaw Thickness (mm)	Jaw Width (mm)	Overall Width (mm)	Cutting Capacity (mm)	
ST70331ST	6"	171.0	9.5	26.0	58.0	Medium Hard Wire Ø 1.6	6
ST70332ST	7"	184.0	10.0	28.0	58.0	Medium Hard Wire Ø 2.0	6
ST70333ST	8"	212.0	10.0	30.0	58.0	Medium Hard Wire Ø 2.0	6

Mini Linesman Pliers

- TPE two-tone anti-slip handle provides superior comfort and grip
- Laser hardened cutting edges cut clean and remain sharp 50% longer
- Clear anti-rust coating prolongs tool life
- Manufactured from chrome-nickel steel for better strength and longer tool life
- Meets or exceeds ASME B107.500



Article Code	Size	Overall Length (mm)	Jaw Thickness (mm)	Jaw Width (mm)	Overall Width (mm)	Cutting Capacity (mm)	
ST70611AST	4"	111.5	6.5	11.0	11.0	Copper Wire Ø 1.5, Iron Wire Ø 1.3, Hard Wire Ø 1.0	6

Mini Long Nose Pliers

- TPE two-tone anti-slip handle provides superior comfort and grip
- Laser hardened cutting edges cut clean and remain sharp 50% longer
- Clear anti-rust coating prolongs tool life
- Manufactured from chrome-nickel steel for better strength and longer tool life
- Meets or exceeds ASME B107.500



Article Code	Size	Overall Length (mm)	Jaw Thickness (mm)	Jaw Width (mm)	Overall Width (mm)	Cutting Capacity (mm)	
ST70612AST	5"	123.5	6.5	11.0	11.0	Copper Wire Ø 1.5, Iron Wire Ø 1.3, Medium Hard Wire Ø 1.0	6

Mini Bent Nose Pliers

- TPE two-tone anti-slip handle provides superior comfort and grip
- Laser hardened cutting edges cut clean and remain sharp 50% longer
- Clear anti-rust coating prolongs tool life
- Manufactured from chrome-nickel steel for better strength and longer tool life
- Meets or exceeds ASME B107.500



Article Code	Size	Overall Length (mm)	Jaw Thickness (mm)	Jaw Width (mm)	Overall Width (mm)	Cutting Capacity (mm)	
ST70613AST	5"	123.5	6.5	11.0	11.0	Copper Wire Ø 1.5, Iron Wire Ø 1.3, Hard Wire Ø 1.0	6

Mini Flat Nose Pliers

- TPE two-tone anti-slip handle provides superior comfort and grip
- Laser hardened cutting edges cut clean and remain sharp 50% longer
- Clear anti-rust coating prolongs tool life
- Manufactured from chrome-nickel steel for better strength and longer tool life
- Meets or exceeds ASME B107.500



Article Code	Size	Overall Length (mm)	Jaw Thickness (mm)	Jaw Width (mm)	Overall Width (mm)	Cutting Capacity (mm)	
ST70614AST	5"	123.5	6.5	11.0	11.0	Copper Wire Ø 1.5, Iron Wire Ø 1.3, Hard Wire Ø 1.0	6

Mini Diagonal Pliers

- TPE two-tone anti-slip handle provides superior comfort and grip
- Laser hardened cutting edges cut clean and remain sharp 50% longer
- Clear anti-rust coating prolongs tool life
- Manufactured from chrome-nickel steel for better strength and longer tool life
- Meets or exceeds ASME B107.500



Article Code	Size	Overall Length (mm)	Jaw Thickness (mm)	Jaw Width (mm)	Overall Width (mm)	Cutting Capacity (mm)	
ST70615AST	4"	110.5	6.5	11.0	11.0	Copper Wire Ø 1.5, Iron Wire Ø 1.3, Hard Wire Ø 1.0	6

Mini End Cutting Pliers

- TPE two-tone anti-slip handle provides superior comfort and grip
- Laser hardened cutting edges cut clean and remain sharp 50% longer
- Clear anti-rust coating prolongs tool life
- Manufactured from chrome-nickel steel for better strength and longer tool life
- Meets or exceeds ASME B107.500



Article Code	Size	Overall Length (mm)	Jaw Thickness (mm)	Jaw Width (mm)	Overall Width (mm)	Cutting Capacity (mm)	
ST70616AST	4"	103.5	13.0	16.5	16.5	Copper Wire Ø 1.5, Iron Wire Ø 1.3, Medium Hard Wire Ø 1.0	6

VDE Insulated End Cutting Nipper



- VDE Certified
- For use in high voltage areas, up to 1000 V alternating current
- Anti-slip handle provides superior comfort and grip
- Clear anti-rust coating prolongs tool life
- Chrome vanadium alloy steel (Cr-V) for exceptional strength and durability
- Meets or exceeds ASME B107.13M



Article Code	Size	Overall Length (mm)	Jaw Thickness (mm)	Jaw Width (mm)	Overall Width (mm)	
ST70141ST	6"	170.0	9.0	24.6	108.3	6

End Cutting Pliers

- Heavy duty cutting edges treated with additional induction hardening
- Polished head resists rust and corrosion
- Professional, ergonomic grips wipe clean easily
- Meets or exceeds ASME B107.500



Article Code	Size	Overall Length (mm)	Overall Width (mm)	
ST70601ME	6"	158.0	47.0	10
ST70602ME	8"	199.0	47.0	10

Groove Joint Pliers

- Angled tooth locking pliers pattern for superior grip
- Interlocking tongue and groove design won't slip
- Multiple jaw positions for optimized handle span and improved gripping comfort
- Induction hardened with angled teeth grip flat, curved, square or hexagonal objects
- Anti-slip handle provides superior comfort and grip
- Chrome vanadium alloy steel (Cr-V) for exceptional strength and durability
- Meets or exceeds ASME B107.500



Article Code	Size	Overall Length (mm)	Jaw Thickness (mm)	Overall Width (mm)	Pipe Diameter (mm)	
ST70411ST	8"	208.0	10.0	48.0	4-31	6
ST70412ST	10"	262.0	11.0	61.0	5-45	6
ST70413ST	12"	321.0	12.0	68.0	5-54	2
ST70414ST	16"	426.0	17.0	71.0	10-92	3

Slip Joint Pliers

- Two different jaw positions with wire cutter near pivot to provide maximum leverage and powerful cutting
- Rivet construction with precision machined joint interlock assures smooth, positive joint action, no chance of slipping position or coming apart under load
- Anti-slip handle provides superior comfort and grip
- Induction hardened with angled teeth grip flat, curved, square or hexagonal objects
- Meets or exceeds ASME B107.500



Article Code	Size	Overall Length (mm)	Jaw Thickness (mm)	Jaw Width (mm)	Overall Width (mm)	Pipe Diameter (mm)	
ST70511ST	6"	160.0	9.5	29.0	55.0	5-30	6
ST70512ST	8"	208.0	10.5	31.0	55.0	6-36	6

2-piece Double X-Pliers Set

- Jaws open wider than the handles for added reach in tight locations
- Flush rivets are stronger and have a thinner profile
- Compound joint opens wider with less effort and minimal handle movement
- Serrated jaws for precision gripping in restricted areas
- TPE two-tone anti-slip handle provides superior comfort and grip
- Manufactured from Chrome Vanadium Steel (Cr-V) for greater strength and durability
- Meets or exceeds ASME B107.500



Article Code	Content	
ST70003U	1 - Straight Double-X Pliers 1 - 45° Double-X Pliers	3

Straight Double-X Pliers

- Jaws open wider than the handles for added reach in tight locations
- Flush rivets are stronger and have a thinner profile
- Compound joint opens wider with less effort and minimal handle movement
- Serrated jaws for precision gripping in restricted areas
- TPE two-tone anti-slip handle provides superior comfort and grip
- Manufactured from Chrome Vanadium Steel (Cr-V) for greater strength and durability
- Meets or exceeds ASME B107.500



Article Code	Size	Overall Length (mm)	Jaw Thickness (mm)	Jaw Width (mm)	
ST70711ST	Straight, 13-1/2"	340.0	10.0	17.0	3

45° Double-X Pliers

- Jaws open wider than the handles for added reach in tight locations
- Flush rivets are stronger and have a thinner profile
- Compound joint opens wider with less effort and minimal handle movement
- Serrated jaws for precision gripping in restricted areas
- TPE two-tone anti-slip handle provides superior comfort and grip
- Manufactured from Chrome Vanadium Steel (Cr-V) for greater strength and durability
- Meets or exceeds ASME B107.500



Article Code	Size	Overall Length (mm)	Jaw Thickness (mm)	Jaw Width (mm)	
ST70721ST	45°, 13-1/2"	355.0	10.0	17.0	3

Wire and Cable Cutting Pliers

- Optimized blade angle for cutting copper and aluminum cable
- Professional dipped grips for easy cleaning and better control
- Anti-slip handle provides superior comfort and grip
- Meets or exceeds ASME B107.500





Article Code	Size	Overall Length (mm)	Jaw Thickness (mm)	Jaw Width (mm)	Overall Width (mm)	Cutting Capacity (mm)	
ST72501ST	6"	150.0	160.0	51.0	13.0	Ø 9	6
ST72502ST	8"	200.0	12.0	68.0	5-54	Ø 11	6
ST72503ST	10"	250.0	17.0	71.0	10-92	Ø 13	6

Plastic Flush Cutting Pliers

- Sharp edges for slicing plastic and vinyl-coated cable
- Professional dipped grips for easy cleaning and better control
- Laser hardened cutting edges cut clean and remain sharp 50% longer
- Chrome vanadium alloy steel (Cr-V) for exceptional strength and durability
- Not for use in cutting metal material
- Meets or exceeds ASME B107.500



 Nature of this product is subject to wear and tear upon usage. Not covered under Lifetime Warranty.

Article Code	Size	Overall Length (mm)	Overall Width (mm)	Cutting Capacity (mm)	
ST70642ST	6"	161.0	55.0	Resin Ø 5	6

Curved Jaw Locking Pliers

- Versatile curved jaw features integral wire cutter
- Angled tooth locking pliers pattern for superior grip
- Compound locking action for powerful non-slip locking grip
- Locking mechanism provides strong and stable hold
- Nickel-plated finish resists rust and corrosion
- Chrome molybdenum alloy steel (Cr-Mo) for exceptional strength and durability
- Meets or exceeds ASME B107.500



Article Code	Size	Overall Length (mm)	Jaw Thickness (mm)	Jaw Width (mm)	Overall Width (mm)	
ST70621ME	7"	189.0	13.0	52.0	52.0	6
ST70622ME	10"	244.0	21.2	65.8	65.8	6

Curved Jaw Locking Pliers

- Versatile curved jaw features integral wire cutter
- Angled tooth locking pliers pattern for superior grip
- Compound locking action for powerful non-slip locking grip
- Locking mechanism provides strong and stable hold
- Nickel-plated finish resists rust and corrosion
- Chrome molybdenum alloy steel (Cr-Mo) for exceptional strength and durability
- Meets or exceeds ASME B107.500



Article Code	Size	Overall Length (mm)	Jaw Thickness (mm)	Jaw Width (mm)	Overall Width (mm)	
ST71101ST	5"	144.0	6.4	37.0	38.0	6
ST71102ST	7"	186.0	7.1	51.0	52.0	6
ST71103ST	10"	244.0	9.7	63.0	65.8	6

X-Jaw Locking Pliers

- Versatile X-jaw features integral wire cutter
- Angled tooth locking pliers pattern for superior grip
- Compound locking action for powerful non-slip locking grip
- Locking mechanism provides strong and stable hold
- Nickel-plated finish resists rust and corrosion
- Chrome molybdenum alloy steel (Cr-Mo) for exceptional strength and durability
- Meets or exceeds ASME B107.500



Article Code	Size	Overall Length (mm)	Jaw Thickness (mm)	Jaw Width (mm)	Overall Width (mm)	
ST71002	10"	220.0	9.7	63.0	65.8	6

Straight Jaw Locking Pliers

- Versatile straight jaw features integral wire cutter
- Angled tooth locking pliers pattern for superior grip
- Compound locking action for powerful non-slip locking grip
- Locking mechanism provides strong and stable hold
- Nickel-plated finish resists rust and corrosion
- Chrome molybdenum alloy steel (Cr-Mo) for exceptional strength and durability
- Meets or exceeds ASME B107.500



Article Code	Size	Overall Length (mm)	Jaw Thickness (mm)	Jaw Width (mm)	Overall Width (mm)	
ST71202ST	7"	185.0	11.2	51.0	52.0	6
ST71203ST	10"	224.0	16.0	57.0	65.8	6

Long Nose Locking Pliers

- Versatile jaw features integral wire cutter
- Angled tooth locking pliers pattern for superior grip
- Compound locking action for powerful non-slip locking grip
- Locking mechanism provides strong and stable hold
- Nickel-plated finish resists rust and corrosion
- Chrome molybdenum alloy steel (Cr-Mo) for exceptional strength and durability
- Meets or exceeds ASME B107.500



Article Code	Size	Overall Length (mm)	Jaw Thickness (mm)	Jaw Capacity (mm)	Max. Cutter Opening (mm)	
ST71301ST	6"	169.0	4.1	62.0	7.0	6
ST71302ST	9"	225.0	4.8	86.0	23	6

Welding Clamp Locking Pliers

- Compound action for powerful non-slip locking grip
- Aggressive grip pattern on tightening knurl
- Locking mechanism provides strong and stable hold
- Nickel-plated finish resists rust and corrosion
- Chrome molybdenum alloy steel (Cr-Mo) for exceptional strength and durability
- Meets or exceeds ASME B107.500



Article Code	Size	Overall Length (mm)	Jaw Thickness (mm)	Jaw Width (mm)	Overall Width (mm)	
ST71401SC	9"	204.0	79.5	62.0	70.0	6

Metal Sheet Clamp Locking Pliers

- Compound action for powerful non-slip locking grip
- Aggressive grip pattern on tightening knurl
- Locking mechanism provides strong and stable hold
- Nickel-plated finish resists rust and corrosion
- Chrome molybdenum alloy steel (Cr-Mo) for exceptional strength and durability
- Meets or exceeds ASME B107.500



Article Code	Size	Overall Length (mm)	Jaw Thickness (mm)	Jaw Width (mm)	Overall Width (mm)	
ST71501SC	8"	232.0	79.5	52.0	78.5	6

C-Clamps Locking Pliers

- Compound action for powerful non-slip locking grip
- Aggressive grip pattern on tightening knurl
- Locking mechanism provides strong and stable hold
- Nickel-plated finish resists rust and corrosion
- Chrome molybdenum alloy steel (Cr-Mo) for exceptional strength and durability
- Meets or exceeds ASME B107.500



Article Code	Size	Overall Length (mm)	Jaw Thickness (mm)	Jaw Capacity (mm)	Jaw Width (mm)	Jaw Depth (mm)	
ST71601SC	11"	280.0	12.7	93.0	139.7	78.0	6

Chain Clamp Locking Pliers

- Compound action for powerful non-slip locking grip
- Aggressive grip pattern on tightening knurl
- Locking mechanism provides strong and stable hold
- Nickel-plated finish resists rust and corrosion
- Chrome molybdenum alloy steel (Cr-Mo) for exceptional strength and durability
- Meets or exceeds ASME B107.500



Article Code	Size	Overall Length (mm)	Jaw Thickness (mm)	Jaw Width (mm)	Chain Length (mm)	
ST71701SC	19"	213.0	5.8	60.7	485.0	6

5 Pc. Combination Snap Ring Pliers Set

Article Code	Content	
ST09251S)	1 - Snap Ring Pliers 1 - 1.2 mm Straight Tip 1 - 14 mm Straight Tip 1 - 45° Tip 1 - 90° Tip	6





Snap Ring Pliers

- Professional dipped grips for easy cleaning and better control
- Heat treated for long lasting durability
- Black oxide finish to resist corrosion
- Tempered steel construction offers strength and durability for long-lasting performance
- Meets or exceeds ASME B107.500

Article Code	Size	Overall Length (mm)	Circlip (mm)	Dia.(±0.2) (mm)	
ST72001ST	External, Straight, 7"	175.0	19.0 - 60.0	Ø 1.7	6

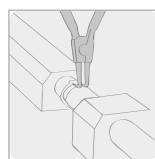
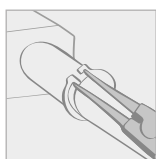
Article Code	Size	Overall Length (mm)	Circlip (mm)	Dia.(±0.2) (mm)	
ST72002ST	External, Curved, 7"	175.0	19.0 - 60.0	Ø 1.7	6



Article Code	Size	Overall Length (mm)	Circlip (mm)	Dia.(±0.2) (mm)	
ST72004ST	Internal, Straight, 7"	175.0	19.0 - 60.0	Ø 1.7	6

Article Code	Size	Overall Length (mm)	Circlip (mm)	Dia.(±0.2) (mm)	
ST72005ST	Internal, Curved, 7"	175.0	19.0 - 60.0	Ø 1.7	6

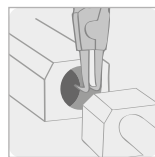
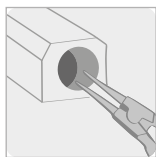

German Style Snap Ring Pliers

- Professional dipped grips for easy cleaning and better control
- Heat treated for long lasting durability
- Black oxide finish to resist corrosion
- Chrome vanadium alloy steel (Cr-V) for exceptional strength and durability
- Meets or exceeds ASME B107.500



Article Code	Size	Overall Length (mm)	Circlip (mm)	Overall Width (mm)	Dia.(±0.2) (mm)	
ST72011ST	External, Straight, 5"	142.0	10.0 - 18.0	50.0	1.25	6
ST72012ST	External, Straight, 7"	175.0	19.0 - 60.0	51.0	1.75	6
ST72013ST	External, Straight, 9"	228.0	32.0 - 80.0	51.0	2.15	6
ST72014ST	External, Straight, 13"	325.0	80.0 - 140.0	50.0	2.95	6



Article Code	Size	Overall Length (mm)	Circlip (mm)	Overall Width (mm)	Dia.(±0.2) (mm)	
ST72021ST	External, Curved, 5"	134.0	10.0 - 18.0	50.0	1.25	6
ST72022ST	External, Curved, 7"	163.0	19.0 - 60.0	51.0	1.75	6
ST72023ST	External, Curved, 9"	213.0	32.0 - 80.0	51.0	2.15	6
ST72024ST	External, Curved, 13"	303.0	80.0 - 140.0	50.0	2.95	6



Article Code	Size	Overall Length (mm)	Circlip (mm)	Overall Width (mm)	Dia.(±0.2) (mm)	
ST72031ST	Internal, Straight, 5"	141.0	10.0 - 18.0	50.0	1.25	6
ST72032ST	Internal, Straight, 7"	180.0	19.0 - 60.0	51.0	1.75	6
ST72033ST	Internal, Straight, 9"	230.0	32.0 - 80.0	51.0	2.15	6
ST72034ST	Internal, Straight, 13"	317.0	80.0 - 140.0	50.0	2.95	6



Article Code	Size	Overall Length (mm)	Circlip (mm)	Overall Width (mm)	Dia.(±0.2) (mm)	
ST72041ST	Internal, Curved, 5"	133.0	10.0 - 18.0	50.0	1.25	6
ST72042ST	Internal, Curved, 7"	169.0	19.0 - 60.0	51.0	1.75	6
ST72043ST	Internal, Curved, 9"	215.0	32.0 - 80.0	51.0	2.15	6
ST72044ST	Internal, Curved, 13"	297.0	80.0 - 140.0	50.0	2.95	6

Electrical Wire Stripper and Crimper

- All-purpose tool includes pliers type nose, crimper, wire cutter, stripper and bolt cutter
- Wire Stripping Range: 0.5 - 6.0 mm
- Crimps insulated and non insulated terminals:
non-insulated auto 7 - 8 mm;
insulated electrical 22 - 20 to 12 - 10 AWG;
electrical 22 - 20 to 22 - 10 AWG
- Bolt cutting range M2.6 to M5
- Professional dipped grips for easy cleaning
- Ergonomic handle with dipping for optimal comfort and control
- Meets or exceeds ASME B107.500



Article Code	Size	Overall Length (mm)	
ST97521ST	8"	200.0	6

Crimping Pliers

- Locking mechanism is easy to operate – push button, set and release
- Made of carbon steel with fiberglass handle
- High accuracy crimping pin securely connects connector with cable wire without any damage

Crimping Pliers for D-SUB Terminals

AWG	Capacity (mm ²)
30 - 24	0.05 - 0.25
22 - 18	0.5 - 1.0



Cat. No.	Size	Overall Length (mm)	Jaw Width (mm)	
ST91101	8"	204.0	67.0	4

Crimping Pliers for European Cable Terminals

AWG	Capacity (mm ²)
22 - 20	0.5 - 0.75
18 - 16	1.0 - 1.5
16 - 14	2.5
14 - 12	4.0
12 - 10	6.0



Cat. No.	Size	Overall Length (mm)	Jaw Width (mm)	
ST91102ST	8"	204.0	67.0	6

Crimping Pliers for Coaxial Cable

Crimping Range (mm ²)
1.72
2.5
5.4
6.48
8.2



Cat. No.	Size	Overall Length (mm)	Jaw Width (mm)	
ST91104ST	9 - 1/2"	241.0	72.0	6

Crimping Pliers for Insulated Terminals

AWG	Capacity (mm ²)
22 - 18	0.5 - 1.0
16 - 14	1.1 - 2.5
12 - 10	4.0 - 6.0



Cat. No.	Size	Overall Length (mm)	Jaw Width (mm)	
ST91105ST	9"	228.0	67.0	6

Crimping Pliers for Non-Insulated Terminals

AWG	Capacity (mm ²)
22 - 16	1.5
16 - 12	2.5 - 4.0
12 - 10	6.0 - 8.0
8 - 6	10.0



Cat. No.	Size	Overall Length (mm)	Jaw Width (mm)	
ST91106ST	10 - 1/4"	260.0	76.0	6

Crimping Pliers for Non-Insulated Terminals

AWG	Capacity (mm ²)
22 - 18	0.5 - 1.0
16 - 14	1.1 - 2.5
12 - 10	4.0 - 6.0

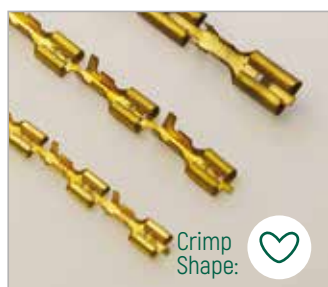

Cat. No.	Size	Overall Length (mm)	Jaw Width (mm)	
ST91107ST	9"	228.0	67.0	6

Cutters & Snips



5 Pc. File Set 8"

Article Code	Content	
ST03901ME	8" Flat File Second Cut 8" Square File Second Cut 8" Three Square File Second Cut 8" Round File Second Cut 8" Half Round File Second Cut	12



 This product is consumable, not within SATA Lifetime Warranty

5 Pc. 3/8" Medium Ratcheting Tap and Die Drive Tool Set

Article Code	Content	
ST50402	1- Ratcheting T-Handle 1- Small Tap Adapter 1- Medium Tap Adapter 1- Die Adapter 1- T-Handle Bar for Adapters	5



 This product is consumable, not within SATA Lifetime Warranty



Wire Stripper with Cutter

- Accurate wire stripping pin for easy cutting of insulated wire surface without damaging the inner wire
- Professional dipped grips for easy cleaning and better control
- Circlip design for convenient storage
- Made of high carbon steel
- Meets or exceeds ASME B107.500





Article Code	Size	Overall Length (mm)	Jaw Thickness (mm)	Jaw Width (mm)	Overall Width (mm)	AWG	Capacity (mm ²)	
ST91201ST	6"	155.0	7.5	51.0	77.0	20 - 30	0.05 - 0.52	6
ST91202ST	7"	183.0	7.5	60.0	77.0	10 - 22	0.52 - 5.26	6

Automatic Wire Stripper

- Accurate wire stripping pin for easy cutting of insulated wire surface without damaging the inner wire
- Anti-slip handle provides superior comfort and grip
- Adjustable wire stop lets you set exactly how much insulation is removed without the need of marking wires
- Spring mechanism automatically returns back to the open position
- Oxide finish to resist corrosion
- Meets or exceeds ASME B107.500



 Nature of this product is subject to wear and tear upon usage. Not covered under Lifetime Warranty.

Article Code	Size	Overall Length (mm)	Wire Capacity (mm)	
ST91212ST	7"	204.0	∅ 0.5, 1.2, 1.6, 2.0	6
ST91213ST	7"	204.0	∅ 1, 1.6, 2.6, 3.2	6

Self Adjusting Wire Stripper

- Self-adjusting with hardened steel blades
- Meets or exceeds ASME B107.500



Article Code	Size	Overall Length (mm)	Jaw Thickness (mm)	Jaw Width (mm)	Wire Stripping Range (mm)	
ST91108ST	6 - 1/2"	170.0	18.5	80.0	Single wire or flat cable of diameter from 0.5 to 6.0	6

Aviation Tin Snips, Left

- Left cuts steel up to 1.2 mm (18 ga)
- Induction hardened serrated cutting edges for a long tool life
- Optimized hand & finger contact points in handle to maximize fit, control, and user ergonomics
- Chrome vanadium alloy steel (Cr-V) for exceptional strength and durability
- Hardened HRC 55 - 60
- Meets or exceeds ASME B107.16M

 Nature of this product is subject to wear and tear upon usage. Not covered under Lifetime Warranty.



Article Code	Size	Overall Length (mm)	Blade Length (mm)	Overall Width (mm)	
ST93101ST	10"	250.00	40.0	77.0	6

Aviation Tin Snips, Right

- Right cuts steel up to 1.2 mm (18 ga)
- Induction hardened serrated cutting edges for a long tool life
- Optimized hand & finger contact points in handle to maximize fit, control, and user ergonomics
- Chrome vanadium alloy steel (Cr-V) for exceptional strength and durability
- Hardened HRC 55 - 60
- Meets or exceeds ASME B107.16M

 Nature of this product is subject to wear and tear upon usage. Not covered under Lifetime Warranty.



Article Code	Size	Overall Length (mm)	Blade Length (mm)	Overall Width (mm)	
ST93102ST	10"	250.00	40.0	77.0	6

Aviation Tin Snips, Straight

- Straight cuts steel up to 1.2 mm (18 ga)
- Induction hardened serrated cutting edges for a long tool life
- Optimized hand & finger contact points in handle to maximize fit, control, and user ergonomics
- Chrome vanadium alloy steel (Cr-V) for exceptional strength and durability
- Hardened HRC 55 - 60
- Induction hardened cutting edges 6 - 62 HRC
- Meets or exceeds ASME B107.16M

 Nature of this product is subject to wear and tear upon usage. Not covered under Lifetime Warranty.



Article Code	Size	Overall Length (mm)	Blade Length (mm)	Overall Width (mm)	
ST93103ST	10"	250.0	40.0	77.0	6
ST93104ST	11"	275.0	80.0	77.0	6

General Long-Blade Scissors



- Stainless steel blades for corrosion resistance, durability and longer tool life
- Precision cut blades for knife-like cutting edges
- Easy adjust pivot bolt allows quick and easy adjustment to fine tune cutting blade tension for optimal cutting performance
- Ambidextrous handle design features symmetrical handle ring contouring for comfortable right or left hand usage
- Straight blades can be sharpened easily
- Hard plastic handles easily wipe clean
- Compact, lightweight scissors
- Used for cutting paper, cardboard, thread, and more



Nature of this product is subject to wear and tear upon usage. Not covered under Lifetime Warranty.

Article Code	Size	Overall Length (mm)	Blade Length (mm)	Handed	
ST93127	10"	250.0	88.0	Both	4

Rubber Grip Long-Blade Scissors



- Precision ground blades for sharper cutting edges and longer blade life
- Off-set angled handle design gives additional clearance and keeps hands above material during cut
- Control channel accommodates index finger for increased control and cutting stability
- Titanium-plated blades for corrosion resistance, durability and longer tool life
- Comfort grip handles with soft-grip texture provide best-in-class comfort and control
- Used for cutting paper, cardboard, heavy fabric, rope, leather, plastics, and more



Nature of this product is subject to wear and tear upon usage. Not covered under Lifetime Warranty.

Article Code	Size	Overall Length (mm)	Blade Length (mm)	Handed	
ST93128	10"	250.0	100.0	Right	4

RUBBER GRIP LONG-BLADE HEAVY DUTY SCISSORS

ST93129

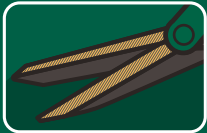

Precision
ground blades



Spring-loaded
design



Full metal core



Comfort grip
handles



Quick release
ergonomic latch



Used for
cutting various
materials



Rubber Grip Long-Blade Heavy Duty Scissors



- Precision ground blades for sharper cutting edges and longer blade life
- Spring-loaded design automatically opens when latch is disengaged for reduced hand fatigue
- Full metal core extends through the handle for maximum strength and increased durability
- Serrated bottom blade grips material as it is being cut for increased cutting control and cleaner cuts
- Quick release ergonomic latch provides consistent easy operation and secures the tool in the closed and locked position for safe storage
- Titanium-plated blades for corrosion resistance, durability and longer tool life
- Comfort grip handles with soft-grip texture provide best-in-class comfort and control
- Used for cutting paper, cardboard, heavy fabric, rope, leather, plastics, and more



Nature of this product is subject to wear and tear upon usage. Not covered under Lifetime Warranty.

Article Code	Size	Overall Length (mm)	Blade Length (mm)	Handed	
ST93129	11"	280.0	100.0	Both	4

Powerful Multi-Purpose Electricians Scissors



- Precision ground blades for sharper cutting edges and longer blade life
- Serrated cutter back capable of plastic tube boring
- Integrated wire strippers in scissor blade for quick and easy wire stripping
- Grip-Zone area in handles for tightening wire nuts and crimping low voltage connections
- Titanium-plated blades for corrosion resistance, durability and longer tool life
- Comfort grip handles with soft-grip texture provide best-in-class comfort and control
- Used for cutting paper, cardboard, thread, wire, and more



Nature of this product is subject to wear and tear upon usage. Not covered under Lifetime Warranty.

Article Code	Size	Overall Length (mm)	Blade Length (mm)	Handed	
ST93125	5"	125.0	70.0	Both	4



Rubber Grip Heavy Duty Scissors

- Precision ground blades for sharper cutting edges and longer blade life
- Compact design allows for easy storage and provides excellent portability
- Internal spring action for smoother operation, avoiding jams
- Quick release ergonomic latch provides consistent easy operation and secures the tool in the closed and locked position for safe storage
- Titanium-plated blades for corrosion resistance, durability and longer tool life
- Comfort grip handles with soft-grip texture provide best-in-class comfort and control
- Used for cutting paper, cardboard, heavy fabric, rope, leather, plastics, and more



Nature of this product is subject to wear and tear upon usage. Not covered under Lifetime Warranty.

Article Code	Size	Overall Length (mm)	Blade Length (mm)	Handed	
ST93126	7"	180.0	44.0	Both	4

Stainless Steel Scissors



- Heavy-duty blades feature premium grade stainless steel and are precision engineered for knife-like cutting edges
- Durable zinc alloy handle is designed with an enlarged lower ring to fit comfortably in the users' hands
- Long blade design maximizes cutting effort
- Handle grips for easy cleaning and better control
- Used for cutting light-gauge metals, screening, floor tiles, vinyl, plastic, leather, paper, rubber, and more



Nature of this product is subject to wear and tear upon usage. Not covered under Lifetime Warranty.

Article Code	Size	Overall Length (mm)	Handed	
ST93122	7"	180.0	Both	12

Antislip Scissors



- With sharp and durable ultra-finished blades
- Optimized blade angle for a precise cutting result
- Spring assist action minimizes hand fatigue
- TPE two-tone anti-slip handle provides superior comfort and grip
- Used for cutting kevlar fabric, copper wire, leather, cardboard, plastic plate, thin aluminum sheet, soft wire, and more



Nature of this product is subject to wear and tear upon usage. Not covered under Lifetime Warranty.

Article Code	Size	Overall Length (mm)	Handed	
ST93121	8"	200.0	Both	10

Multi-Purpose Scissors



- With sharp and durable ultra-finished blades
- Designed with small-angle cutting edge for cutting hard objects
- Spring assist action minimizes hand fatigue
- Adjustable bolted joint for easy maintenance
- Optimized hand & finger contact points in handle to maximize fit, control, and user ergonomics
- Used for cutting 4-conductor copper cable, soft wire, leather, cardboard, plastic board, thin aluminum sheet, and more



Nature of this product is subject to wear and tear upon usage. Not covered under Lifetime Warranty.

Article Code	Size	Overall Length (mm)	Handed	
ST93106	8"	200.0	Both	10



Multi-Purpose Scissors, Curved Blades

- With sharp and durable ultra-finished blades
- Designed with small-angle cutting edge for cutting hard objects
- Spring assist action minimizes hand fatigue
- Adjustable bolted joint for easy maintenance
- Optimized hand & finger contact points in handle to maximize fit, control, and user ergonomics
- Used for cutting 4-conductor copper cable, soft wire, leather, cardboard, plastic board, thin aluminum sheet, and more



Nature of this product is subject to wear and tear upon usage. Not covered under Lifetime Warranty.

Article Code	Size	Overall Length (mm)	Handed	
ST93107	7"	180.0	Right	10

Electricians Scissors



- With sharp and durable ultra-finished blades
- Special anti-slip groove for keeping itself from slipping during wire cutting
- Designed with small-angle cutting edge for cutting hard objects
- Spring assist action minimizes hand fatigue
- Adjustable bolted joint for easy maintenance
- Durable two-tone grip provides comfort, control, and slip prevention
- Used for cutting 4-conductor copper cable, soft wire, leather, cardboard, plastic board, thin aluminum sheet, and more



Nature of this product is subject to wear and tear upon usage. Not covered under Lifetime Warranty.

Article Code	Size	Overall Length (mm)	Handed	
ST93105	7"	180.0	Both	10

Diagonal Cutter

NEW

- With sharp and durable ultra-finished blades
- Optimized blade angle for a precise cutting result
- Spring assist action minimizes hand fatigue
- Optimized hand & finger contact points in handle to maximize fit, control, and user ergonomics
- Used for cutting 4-conductor copper cable, soft wire up to 0.5 mm in diameter, and more



 Nature of this product is subject to wear and tear upon usage. Not covered under Lifetime Warranty.

Article Code	Size	Overall Length (mm)	Handed	
ST93110	7"	180.0	Both	10

Heavy Duty Cable Cutter

NEW

- With sharp and durable ultra-finished blades
- Optimized blade angle for a precise cutting result
- Spring assist action minimizes hand fatigue
- Adjustable bolted joint for easy maintenance
- Optimized hand & finger contact points in handle to maximize fit, control, and user ergonomics
- Used for cutting copper, aluminum cables up to 16 mm in diameter, and more



 Nature of this product is subject to wear and tear upon usage. Not covered under Lifetime Warranty.

Article Code	Size	Overall Length (mm)	Handed	
ST93109	7	180.0	Both	10

Coaxial Cable Cutter



- With sharp and durable ultra-finished blades
- Optimized blade angle for a precise cutting result
- Spring assist action minimizes hand fatigue
- Adjustable bolted joint for easy maintenance
- Optimized hand & finger contact points in handle to maximize fit, control, and user ergonomics
- Used for cutting copper, aluminum cables up to 10 mm in diameter, and more



Nature of this product is subject to wear and tear upon usage. Not covered under Lifetime Warranty.

Article Code	Size	Overall Length (mm)	Handed	
ST93108	7"	180.0	Both	10

Straight Pattern Tinner's Snips



- With sharp and durable ultra-finished blades
- High frequency quenching during manufacturing ensures a hardened edge with a smooth cut
- Superior design prevents tears at end of cuts by controlling blade bypass; minimizes folding and burrs
- Retractable spring for easy storage
- Heat treated for long lasting durability
- Professional dipped grips for easy cleaning and better control
- Bright, full polish finish easily wipes clean and resists corrosion



Nature of this product is subject to wear and tear upon usage. Not covered under Lifetime Warranty.

Article Code	Size	Overall Length (mm)	Handed	
ST93201	8"	200.0	Both	6
ST93202	10"	250.0	Both	6
ST93203	12"	300.0	Both	6
ST93204	14"	350.0	Both	5

Straight Pattern Tinner's Snip

- Cuts cold rolled steel
- Drop forged construction
- Induction hardened serrated cutting edges for a long tool life
- Comfort grips for ease of use and slip protection
- For trimming extra heavy stock
- Meets or exceeds ASME B107.16M



 Nature of this product is subject to wear and tear upon usage. Not covered under Lifetime Warranty.

Article Code	Size	Overall Length (mm)	Blade Length (mm)	Overall Width (mm)	Cold Rolled Iron Sheet (mm)	Stainless Steel Sheet (mm)	
ST93302ST	8"	205.0	40.0	87.0	0.61	0.41	6
ST93303ST	10"	254.0	60.0	105.0	0.78	0.45	6
ST93304ST	12"	305.0	70.0	110.0	0.91	0.63	12
ST93305ST	14"	355.0	90.0	110.0	1.2	0.7	6
ST93306ST	16"	425.0	100.0	145.0	1.6	1.0	6

Heavy Duty Bolt Cutter

- Drop forged, precision ground alloy steel jaws for maximum durability and cut life
- Cuts low carbon steel and carbon steel
- Center cut jaws
- Ergonomic non-slip grips for safe cutting
- Adjustable jaw for better cuts, depending on the material
- Hardened steel jaws with angled cutting grooves
- Meets or exceeds ASME B107.16M



 Nature of this product is subject to wear and tear upon usage. Not covered under Lifetime Warranty.

Article Code	Size	Overall Length (mm)	Overall Width (mm)	Cutting Capacity (mm)	
ST93501SC	8"	212.5	63.5	Low Carbon Steel \varnothing 3.17 (1/8"), Medium Carbon Steel \varnothing 3.17 (1/8")	6

Heavy Duty Bolt Cutter

- Drop forged, precision ground alloy steel jaws for maximum durability and cut life
- Cuts low carbon steel and carbon steel
- Center cut jaws
- Ergonomic non-slip grips for safe cutting
- Adjustable jaw for better cuts, depending on the material
- Hardened steel jaws with angled cutting grooves
- Meets or exceeds ASME B107.16M



 Nature of this product is subject to wear and tear upon usage. Not covered under Lifetime Warranty.

Article Code	Size	Overall Length (mm)	Overall Width (mm)	Cutting Capacity (mm)	
ST93502ST	12"	325.0	139.0	Low Carbon Steel Ø 5 (3/16"), Medium Carbon Steel Ø 4 (5/12")	1
ST93503ST	14"	370.0	140.0	Low Carbon Steel Ø 7 (1/4"), Medium Carbon Steel Ø 5 (3/16")	1
ST93504ST	18"	470.0	141.0	Low Carbon Steel Ø 8 (5/16"), Medium Carbon Steel Ø 6 (1/4")	1
ST93505ST	24"	634.0	160.0	Low Carbon Steel Ø 10 (3/8"), Medium Carbon Steel Ø 8 (5/16")	1
ST93506ST	30"	765.0	180.0	Low Carbon Steel Ø 13 (1/2"), Medium Carbon Steel Ø 10 (3/8")	1
ST93507ST	36"	917.0	190.0	Low Carbon Steel Ø 16 (5/8"), Medium Carbon Steel Ø 12 (7/16")	1
ST93508ST	42"	1053.0	210.0	Low Carbon Steel Ø 19 (3/4"), Medium Carbon Steel Ø 14 (9/16")	1
ST93509ST	48"	1213.0	250.0	Low Carbon Steel Ø 22 (7/8"), Medium Carbon Steel Ø 16 (5/8")	1

Wire Rope Cutter

- Optimized blade angle for a precise cutting result
- Anti-slip handles provide superior comfort and grip
- Blades made of chrome vanadium alloy steel (Cr-V) for exceptional strength and durability
- Used for cutting steel cable, coarse or fine stranded cable, wire rope, spring steel wire, and more



 Nature of this product is subject to wear and tear upon usage. Not covered under Lifetime Warranty.

Article Code	Size	Overall Length (mm)	Handed	
ST93601	8"	200.0	Both	6



Wire Rope Cutter

- Optimized blade angle for a precise cutting result
- Anti-slip handles provide superior comfort and grip
- Handles constructed from aluminum alloy for lightness and durability
- Blades made of chrome vanadium alloy steel (Cr-V) for exceptional strength and durability
- Used for cutting wire rope (Ø5 mm), spring steel wire (Ø1.6 mm), steel cable, coarse or fine stranded cable, and more



Nature of this product is subject to wear and tear upon usage. Not covered under Lifetime Warranty.

Article Code	Size	Overall Length (mm)	Handed	
ST93603	24"	600.0	Both	1

Zinc Alloy Snap-Off Knife, 13-Point



- Steel blade sleeve for increased durability
- Body made of durable zinc alloy steel for longer tool life
- SK2 blades available for extended blade life
- Compact, ergonomic design
- Replacement Blades: ST93432A

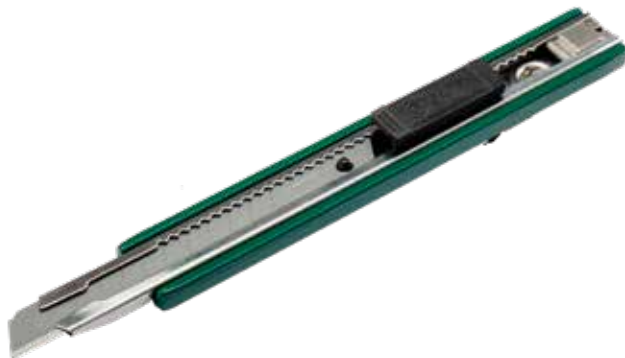

Nature of this product is subject to wear and tear upon usage. Not covered under Lifetime Warranty.

Article Code	Blade Length (mm)	Blade Width (mm)	Blade Thickness (mm)	
ST93424A	80.0	9.0	0.4	12



Zinc Alloy Snap-Off Knife, 8-Point

- Steel blade sleeve for increased durability
- Body made of durable zinc alloy steel for longer tool life
- SK2 blades available for extended blade life
- Compact, ergonomic design
- Replacement Blades: ST93436, ST93433A & ST93437

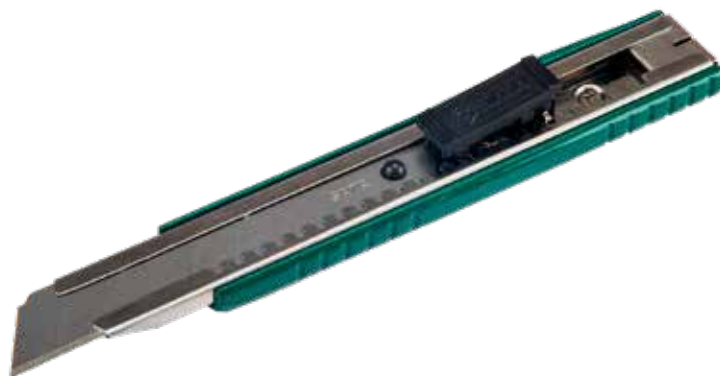

 Nature of this product is subject to wear and tear upon usage. Not covered under Lifetime Warranty.

Article Code	Blade Length (mm)	Blade Width (mm)	Blade Thickness (mm)	
ST93425A	100.0	18.0	0.5	8

Plastic Snap-off Knife, 13-point

- Built in blade snapper that slides out of the body for easy access
- SK2 blades available for extended blade life
- Steel blade sleeve for increased durability
- 13-point snap-off blade
- Replacement Blades: ST93432A



 Nature of this product is subject to wear and tear upon usage. Not covered under Lifetime Warranty.

Article Code	Blade Length (mm)	Blade Width (mm)	Blade Thickness (mm)	
ST93426SC	80.0	9.0	0.4	12

Rubber Grip Snap-off Knife, 8-point

- Built in blade snapper that slides out of the body for easy access
- SK2 blades available for extended blade life
- Steel blade sleeve for increased durability
- Comfort grip for ease of use and slip protection
- 8-point snap-off blade
- Replacement Blades: ST93436, ST93433A & ST93437



 Nature of this product is subject to wear and tear upon usage. Not covered under Lifetime Warranty.

Article Code	Blade Length (mm)	Blade Width (mm)	Blade Thickness (mm)	
ST93428SC	100.0	18.0	0.5	12

Plastic Snap-Off Knife, 8-Point

- Steel blade sleeve for increased durability
- Durable ABS housing prolongs tool life
- SK2 blades available for extended blade life
- Comfort grip for ease of use and slip protection
- Ergonomic grip reducing hand fatigue
- Replacement Blades: ST93436, ST93433A & ST93437



 Nature of this product is subject to wear and tear upon usage. Not covered under Lifetime Warranty.

Article Code	Blade Length (mm)	Blade Width (mm)	Blade Thickness (mm)	
ST93422A	100.0	18.0	0.5	10

Plastic Snap-off Knife, 8-point

- Built in blade snapper that slides out of the body for easy access
- SK2 blades available for extended blade life
- Steel blade sleeve for increased durability
- Comfort grip for ease of use and slip protection
- 8-point snap-off blade
- Replacement Blades: ST93433A & ST93437



 Nature of this product is subject to wear and tear upon usage. Not covered under Lifetime Warranty.

Article Code	Blade Length (mm)	Blade Width (mm)	Blade Thickness (mm)	
ST93429	100.0	18.0	0.5	12

T Series Rubber Grip Snap-Off Knife, 13-Point



- Steel blade sleeve for increased durability
- Unique dual material case with thumb bridge for added comfort
- SK2 blades available for extended blade life
- Ergonomic dual material improves grip while reducing hand fatigue
- Replacement Blades: ST93432A



Nature of this product is subject to wear and tear upon usage. Not covered under Lifetime Warranty.

Article Code	Blade Length (mm)	Blade Width (mm)	Blade Thickness (mm)	
ST93481	80.0	9.0	0.4	12

T Series 18 mm Soft Grip Utility Knife

- Steel blade sleeve for increased durability
- Unique dual material case with thumb bridge for added comfort
- Built in blade snapper that slides out of the body for easy access
- SK2 blades available for extended blade life
- Ergonomic dual material improves grip while reducing hand fatigue
- Replacement Blades: ST93433A & ST93437



Nature of this product is subject to wear and tear upon usage. Not covered under Lifetime Warranty.

Article Code	Blade Length (mm)	Blade Width (mm)	Blade Thickness (mm)	
ST93482	100.0	18.0	0.5	8

T Series Rubber Grip Snap-Off Knife, 7-Point



- Steel blade sleeve for increased durability
- Unique dual material case with thumb bridge for added comfort
- SK2 blades available for extended blade life
- Ergonomic dual material improves grip while reducing hand fatigue
- Replacement Blades: ST93438



Nature of this product is subject to wear and tear upon usage. Not covered under Lifetime Warranty.

Article Code	Blade Length (mm)	Blade Width (mm)	Blade Thickness (mm)	
ST93483	125.0	25.0	0.5	6

Folding Utility Knife

- Blade locks in the open position for secure cutting
- Easy access blade storage compartment in the body holds additional blades
- Quick blade replacement for user convenience
- SK2 blades available for extended blade life
- Ergonomic dual material improves grip while reducing hand fatigue
- Includes one loaded blade
- Replacement Blades: ST93434A & ST93435A



 Nature of this product is subject to wear and tear upon usage. Not covered under Lifetime Warranty.

Article Code	Blade Length (mm)	Blade Width (mm)	Blade Thickness (mm)	
ST93486	60.0	19.0	0.6	8

Zinc Alloy Utility Knife

- Zinc phosphate coating for corrosion resistance
- SK2 blades available for extended blade life
- Comfort grip for ease of use and slip protection
- Easy access blade storage compartment in the body holds additional blades
- Includes 5 spare blades which are stored inside the body
- Replacement Blades: ST93434A & ST93435A



 Nature of this product is subject to wear and tear upon usage. Not covered under Lifetime Warranty.

Article Code	Blade Length (mm)	Blade Width (mm)	Blade Thickness (mm)	
ST93441SC	60.0	19.0	0.6	6

Self-Retracting Utility Knife

- Blade automatically retracts when it loses contact with cut material to ensure safety when cutting
- Easy access blade storage compartment in the body holds additional blades
- Quick blade replacement for user convenience
- Unique dual material, ergonomically designed comfort grip. Ideal for repeated cuts
- Includes 5 professional spare blades made from SK2 carbon steel
- Replacement Blades: ST93434A & ST93435A



 Nature of this product is subject to wear and tear upon usage. Not covered under Lifetime Warranty.

Article Code	Blade Length (mm)	Blade Width (mm)	Blade Thickness (mm)	
ST93442SC	60.0	19.0	0.6	8

Heavy Duty Utility Knife

- Zinc phosphate coating for corrosion resistance
- SK2 blades available for extended blade life
- Comfort grip for ease of use and slip protection
- Includes 5 spare blades which are stored inside the body
- Replacement Blades: ST93434A & ST93435A





 Nature of this product is subject to wear and tear upon usage. Not covered under Lifetime Warranty.

Article Code	Blade Length (mm)	Blade Width (mm)	Blade Thickness (mm)	
ST93443SC	60.0	19.0	0.6	8

Multipurpose Zinc Alloy Utility Knife

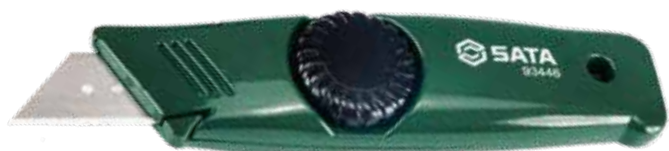
- Zinc phosphate coating for corrosion resistance
- Rotate lock design
- SK2 blades available for extended blade life
- Comfort grip for ease of use and slip protection
- Includes 5 spare blades which are stored inside the body
- Replacement Blades: ST93434A & ST93435A



 Nature of this product is subject to wear and tear upon usage. Not covered under Lifetime Warranty.

Article Code	Blade Length (mm)	Blade Width (mm)	Blade Thickness (mm)	
ST93446SC	60.0	19.0	0.6	8

Auto-Retracting Safety Utility Knife

- Blade retracts automatically the moment it loses contact with the material being cut
- Unique dual material case with thumb bridge for added comfort
- SK2 blades available for extended blade life
- Ergonomic dual material improves grip while reducing hand fatigue
- Blade storage compartment in the handle holds additional blades for easy access
- Auto-retract mechanism cannot be overridden under normal use
- Blade retracts on loss of contact even if the user is still holding the blade slider forward in the 'open' position
- Helps reduce workplace injuries, lowering lost time and increasing productivity
- Quick and easy blade change
- Replacement Blades: ST93434A & ST93435A



NEW

11

 Nature of this product is subject to wear and tear upon usage. Not covered under Lifetime Warranty.

Article Code	Blade Length (mm)	Blade Width (mm)	Blade Thickness (mm)	
ST93485	60.0	19.0	0.6	8

10 Pc. Spare Blades, 7-Point

- High quality, SK2 steel utility knife blades with sharp points
- Includes 10 blades, 2 in black and 8 in silver
- 7-point snap-off design keeps the blade always sharp and ready to go
- Suitable for ST93483



 Nature of this product is subject to wear and tear upon usage. Not covered under Lifetime Warranty.

Article Code	Blade Length (mm)	Blade Width (mm)	Blade Thickness (mm)	
ST93438	125.0	25.0	0.5	12

10 Pc. Spare Blades, 8-Point

- High quality, SK2 steel utility knife blades with sharp points
- Contains 10 silver blades
- 8-point snap-off design keeps the blade always sharp and ready to go
- Suitable for ST93422A, ST93425A and ST93428C



 Nature of this product is subject to wear and tear upon usage. Not covered under Lifetime Warranty.

Article Code	Blade Length (mm)	Blade Width (mm)	Blade Thickness (mm)	
ST93436	100.0	18.0	0.5	10

10 Pc. Spare Blades, 8-Point

- High quality, SK2 steel utility knife blades with sharp points
- Includes 10 blades, 2 in black and 8 in silver
- 8-point snap-off design keeps the blade always sharp and ready to go
- Suitable for ST93422A, ST93425A, ST93428SC, ST93429 and ST93482



 Nature of this product is subject to wear and tear upon usage. Not covered under Lifetime Warranty.

Article Code	Blade Length (mm)	Blade Width (mm)	Blade Thickness (mm)	
ST93433A	100.0	18.0	0.5	10

10 Pc. Spare Blades, 13-Point

- High quality, SK2 steel utility knife blades with sharp points
- Includes 10 blades, 2 in black and 8 in silver
- 13-point snap-off design keeps the blade always sharp and ready to go
- Suitable for ST93424A, 93426SC and ST93481



 Nature of this product is subject to wear and tear upon usage. Not covered under Lifetime Warranty.

Article Code	Blade Length (mm)	Blade Width (mm)	Blade Thickness (mm)	
ST93432A	80.0	9.0	0.	10

10 Pc. Spare Blades, 15-Point

- High quality, SK2 steel utility knife blades with sharp points
- Includes 10 blades, 2 in black and 8 in silver
- 15-point snap-off design keeps the blade always sharp and ready to go
- Suitable for ST93422A, ST93425A, ST93428SC, ST93429 and ST93482



 Nature of this product is subject to wear and tear upon usage. Not covered under Lifetime Warranty.

Article Code	Blade Length (mm)	Blade Width (mm)	Blade Thickness (mm)	
ST93437	100.0	18.0	0.5	10

10 Pc. Spare Utility Blades

- High quality, SK2 steel utility knife blades with sharp points
- Contains 10 silver blades
- Blade packaging is designed to safely and easily access spare blades reducing risk of injury
- Suitable for ST93441SC, ST93442SC, ST93443SC, ST93446SC, ST93485 and ST93486



 Nature of this product is subject to wear and tear upon usage. Not covered under Lifetime Warranty.

Article Code	Blade Length (mm)	Blade Width (mm)	Blade Thickness (mm)	
ST93434A	60.0	19.0	0.6	18

100 Pc. Spare Utility Blades

- High quality, SK2 steel utility knife blades with sharp points
- Contains 100 silver blades
- Blade packaging is designed to safely and easily access spare blades reducing risk of injury
- Suitable for ST93441SC, ST93442SC, ST93443SC, ST93446SC, ST93485 and ST93486



Nature of this product is subject to wear and tear upon usage. Not covered under Lifetime Warranty.

Article Code	Blade Length (mm)	Blade Width (mm)	Blade Thickness (mm)	
ST93435A	60.0	19.0	0.6	12

Wire Stripping Knife, Straight Blades

- With sharp and durable ultra-finished blade
- Durable two-tone grip provides comfort, control, and slip prevention
- For use in electric power and related industry wire and cable work



Nature of this product is subject to wear and tear upon usage. Not covered under Lifetime Warranty.

Article Code	Total Length (mm)	
ST93473	185.0	10

Wire Stripping Knife, Curved Blades

- With sharp and durable ultra-finished blade
- Durable two-tone grip provides comfort, control, and slip prevention
- Scythe hook blade with sliding guard on cutting tip ensures blade will not damage inner core of the wire
- For use in electric power and related industry wire and cable work



Nature of this product is subject to wear and tear upon usage. Not covered under Lifetime Warranty.

Article Code	Total Length (mm)	
ST93474	185.0	10

VDE Cable Knife



- VDE Certified
- For use in high voltage areas, up to 1000 V alternating current
- With sharp and durable ultra-finished blade
- Durable two-tone grip provides comfort, control, and slip prevention
- Scythe hook blade with sliding guard on cutting tip ensures blade will not damage inner core of the wire
- For use in electric power and related industry wire and cable work
- Red color for quick identification of VDE

Nature of this product is subject to wear and tear upon usage. Not covered under Lifetime Warranty.



Article Code	Total Length (mm)	
ST93470SC	185.0	6

Mini Tubing Cutter

- Ideal for handyman, plumbers, electricians and vehicle mechanics
- Large knurled knob for non-slip grip and precise control
- Compact size for use in tight spaces

Nature of this product is subject to wear and tear upon usage. Not covered under Lifetime Warranty.



Article Code	Overall Length (mm)	Overall Width (mm)	Cutting Capacity (mm)	
ST97305ST	197.0	155.0	3 - 16 (0.12" - 5/8")	6

Tubing Cutter

- Durable steel construction
- Large knurled handle for maximum grip power
- Spare cutter wheel stored in the handle

Nature of this product is subject to wear and tear upon usage. Not covered under Lifetime Warranty.





Article Code	Overall Length (mm)	Overall Width (mm)	Cutting Capacity (mm)	
ST97301ST	245.0	210.0	3 - 28 (0.12 - 1.18")	12
ST97302ST	245.0	210.0	3 - 32 (0.12 - 1-1/4")	12

Tubing Cutter

- Durable steel construction
- Large knurled handle for maximum grip power
- Spare cutter wheel stored in the handle



 Nature of this product is subject to wear and tear upon usage. Not covered under Lifetime Warranty.

Article Code	Overall Length (mm)	Overall Width (mm)	Cutting Capacity (mm)	
ST97303ST	300.0	140.0	6 - 64 (1/4" - 2-1/2")	12

2 Pc. Replacement Cutter Wheels

- For cutting copper, aluminum, brass and thin wall tubing
- Tempered steel offers strength and durability for long-lasting performance
- Black oxide finish to resist corrosion
- Blade for ST97301ST, ST97302ST and ST97305ST Tubing Cutter



 Nature of this product is subject to wear and tear upon usage. Not covered under Lifetime Warranty.

Article Code	Overall Width (mm)	Overall Length (mm)	Cutting Capacity (mm)	
ST97311ST	155.0	197.0	3.0 x 18.0	12

2 Pc. Replacement Cutter Wheels

- For cutting copper, aluminum, brass and thin wall tubing
- Tempered steel offers strength and durability for long-lasting performance
- Black oxide finish to resist corrosion
- Blade for ST97303ST Tubing Cutter



 Nature of this product is subject to wear and tear upon usage. Not covered under Lifetime Warranty.

Article Code	Cutting Capacity (mm)	
ST97312ST	6.2 x 18.0, 6.2 x 22.0	6

PVC Pipe Cutter

- Heat treated stainless steel blade for long lasting durability
- Handle latch keeps tool closed during storage or when not in use



 Nature of this product is subject to wear and tear upon usage. Not covered under Lifetime Warranty.

Article Code	Cutting Capacity (mm)	
ST97304ST	3.0 - 42.0 (0.1" - 1-1/2")	6

Ratcheting Cable Cutter

- Drop forged, precision ground alloy steel jaws for maximum durability and cut life
- Special ratcheting tooth mechanism
- Ergonomic handles and ratcheting action for comfort during repeated cuts
- Compact and lightweight design



 Nature of this product is subject to wear and tear upon usage. Not covered under Lifetime Warranty.

Article Code	Overall Length (mm)	Cutting Capacity (mm)	
ST72511	245.0	up to 240 mm ² (0.372 ^{m2})	3

Mini Hack Saw

- ABS handle provides comfort and durability
- Sawtooth body made of high quality spring steel
- Sawtooth edges made of high-speed steel
- Powerful and sharp sawtooth, for smooth cutting and long lasting durability
- One bi-metal 6" saw blade included



 Nature of this product is subject to wear and tear upon usage. Not covered under Lifetime Warranty.

Article Code	Size	Overall Length (mm)	
ST93404	6"	150.0	6

Aluminum Hacksaw

- Ergonomic handle increases overall comfort
- Sawtooth body made of high quality spring steel
- Sawtooth edges made of high-speed steel
- Powerful and sharp sawtooth, for smooth cutting and long lasting durability
- One bi-metal 12" saw blade included



 Nature of this product is subject to wear and tear upon usage. Not covered under Lifetime Warranty.

Article Code	Size	Overall Length (mm)	
ST93405SC	12"	300.0	6

Wood Handle Hacksaw

- Solid steel body construction for strength and durability
- Heat treated tension and butterfly fastening bolts ensure longer tool life
- Comfortable and ergonomic beech handles improves grip while reducing hand fatigue
- Lightweight ergonomic design



 Nature of this product is subject to wear and tear upon usage. Not covered under Lifetime Warranty.

Article Code	Size	Overall Length (mm)	
ST93413	12"	300.0	6

3 Pc. Mini Hacksaw Blades

- Durable and resilient sawtooth design for smoother cuts with less friction
- 3 blades per package
- For Mini Hacksaw ST93404



 Nature of this product is subject to wear and tear upon usage. Not covered under Lifetime Warranty.

Article Code	Size	Overall Length (mm)	
ST93411	6"	150.0	12



12" Hacksaw Blade

- Saw blade constructed from high-speed-steel for strength and to maintain sharpness for smooth cutting
- Precision hardened teeth for improved cutting performance
- High frequency heat treated teeth maintains sharpness over tool life
- For cutting metals such as stainless steel, alloy steel, bearing steel, carbon steel, spring steel, cast iron, aluminum and copper

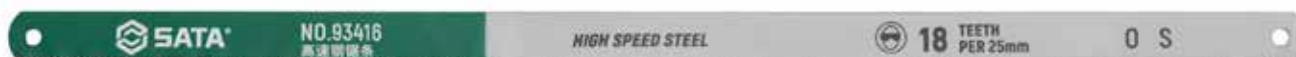

Nature of this product is subject to wear and tear upon usage. Not covered under Lifetime Warranty.

Article Code	Size	Overall Length (mm)	Number of Teeth	Application	
ST93416	12"	300.0	18	For sawing 1/4" to 1" thick material	10
ST93417	12"	300.0	24	For sawing 1/8" to 1/4" thick material	10
ST93418	12"	300.0	32	For sawing 1/8" or thinner material	10

100 Pc. Bi-Metal Saw Blade

- Sawtooth body made of high quality spring steel
- Sawtooth edges made of high-speed steel
- Powerful and sharp sawtooth, for smooth cutting and long lasting durability



Nature of this product is subject to wear and tear upon usage. Not covered under Lifetime Warranty.

Article Code	Size	Teeth per inch	Application	
ST93404ME	12"	18	For sawing 1/4" to 1" thick material, pipe, angle iron and steel bar	1
ST93405ME	12"	24	For sawing 1/8" to 1/4" thick material, conduit, heavy steel metal and tubing	1
ST93406ME	12"	32	For sawing 1/8" or thinner metal, thin sheet metal and metal trim	1

Wood Handle Hand Saw

- Precision hardened teeth for improved cutting performance
- Hardened area at cutting edge around each tooth, softer core avoids tooth rippage
- Teeth sharpened on both sides to provide faster and cleaner cuts
- High frequency heat treated teeth to maintain sharpness
- For cutting wood fiber



! Nature of this product is subject to wear and tear upon usage. Not covered under Lifetime Warranty.

Article Code	Size	Overall Length (mm)	Teeth per inch	
ST93621ME	16"	400.0	7	6
ST93622ME	18"	450.0	7	6
ST93623ME	20"	500.0	7	6
ST93624ME	22"	550.0	7	6
ST93625ME	24"	600.0	7	6

Bi-Metal Hole Saw

- Designed to cut wood, copper, aluminum, metal and stainless steel
- High-speed, HRC 65 - 68 steel constructed teeth for faster cutting and longevity
- Body constructed from alloy steel sheet for superior safety and durability
- Specialized tooth design for higher cutting efficiency



! Nature of this product is subject to wear and tear upon usage. Not covered under Lifetime Warranty.

Article Code	Size	
ST53301	16.0 mm	20
ST53302	19.0 mm	20
ST53303	20.0 mm	20
ST53304	22.0 mm	20
ST53305	25.0 mm	20
ST53306	30.0 mm	20
ST53307	32.0 mm	12

Article Code	Size	
ST53308	35.0 mm	12
ST53309	38.0 mm	12
ST53310	44.0 mm	18
ST53311	51.0 mm	18
ST53312	57.0 mm	12
ST53313	60.0 mm	12
ST53314	64.0 mm	12

Hole Saw Arbor

- Used for connecting the hole saw and drill chuck, and also for positioning when the hole saw is working
- Guide drill bit made of high speed alloy steel for strength and durability
- Quick release spring allows the round disc to easily be taken out after cutting



! Nature of this product is subject to wear and tear upon usage. Not covered under Lifetime Warranty.

Article Code	Applicable Aperture (mm)	Drill Pipe Diameter (mm)	
ST53401	14.0 - 30.0	9.5	16
ST53402	32.0 - 152.0	11.1	12



Screwdrivers & Nut Drivers



6 Pc. Acetate Combination Screwdriver Set

Article Code	Content	
ST09303ESJ	3 - Acetate Screwdrivers Phillips #0x75 mm, #1x100 mm, #2x100 mm 3 - Acetate Screwdrivers Slotted 3.2x75 mm, 5x75 mm, 6x100 mm	5



8 Pc. Acetate Combination Screwdriver Set

Article Code	Content	
ST09306SJ	4 - Acetate Screwdrivers Phillips #1x75 mm, #2x38 mm, #2x100 mm, #2x150 mm 4 - Acetate Screwdrivers Slotted 5x75 mm, 6x38 mm, 6x100 mm, 6x150 mm	5



10 Pc. Acetate Combination Screwdriver Set

Article Code	Content	
ST09304ESJ	5 - Acetate Screwdrivers Phillips #1x100 mm, #2x38 mm, #2x100 mm, #2x150 mm, #3x150 mm 5 - Acetate Screwdrivers Slotted 5x75 mm, 6x38 mm, 6x100 mm, 6x150 mm, 8x150 mm	4



8 Pc. Acetate Torx® Screwdriver Set

Article Code	Content	
ST09305SJ	T8x75 mm, T10x100 mm, T15x100 mm, T20x100 mm, T25x100 mm, T27x100 mm, T30x100 mm, T40x100 mm	5



Acetate Screwdriver Slotted

- Blade is made of high performance alloy steel for maximum strength and durability
- Ergonomic acetate handle provides increased comfort and maximized torque
- 100% solid impact resistant acetate handle for lasting durability
- Oil and solvent resistant handle provides a longer tool life
- Handle designed with "through hole" for easy storage
- Tempered steel construction offers strength and durability for long-lasting performance
- Meets or exceeds ASME B107.600



Article Code	Size (mm)	Shank Length (mm)	Overall Length (mm)	Handle Diameter (mm)	
ST62202SC	3.2	75.0	146.0	23.0	12
ST62203SC	3.2	100.0	172.0	23.0	12
ST62204SC	3.2	150.0	221.0	23.0	12
ST62205SC	3.2	200.0	271.0	23.0	12
ST62207SC	5.0	75.0	165.0	28.0	12
ST62208SC	5.0	100.0	190.0	28.0	12
ST62209SC	5.0	150.0	240.0	28.0	6
ST62210SC	5.0	200.0	290.0	28.0	12
ST62211SC	6.0	38.0	99.0	35.0	6
ST62212SC	6.0	100.0	202.0	32.0	12
ST62213SC	6.0	150.0	252.0	32.0	12
ST62214SC	6.0	200.0	312.0	32.0	12
ST62215SC	6.0	250.0	352.0	32.0	12
ST62216SC	8.0	150.0	260.0	35.0	12
ST62217SC	8.0	200.0	312.0	35.0	12

Acetate Screwdriver Phillips

- Blade is made of high performance alloy steel for maximum strength and durability
- Ergonomic acetate handle provides increased comfort and maximized torque
- 100% solid impact resistant acetate handle for lasting durability
- Oil and solvent resistant handle provides a longer tool life
- Handle designed with "through hole" for easy storage
- Tempered steel construction offers strength and durability for long-lasting performance
- Meets or exceeds ASME B107.600



Article Code	Size	Shank Length (mm)	Overall Length (mm)	Handle Diameter (mm)	
ST62302SC	#0	75.0	146.0	23.0	6
ST62303SC	#0	100.0	221.0	23.0	6
ST62304SC	#0	150.0	222.0	23.0	6
ST62305SC	#0	200.0	272.0	23.0	6
ST62307SC	#1	75.0	166.0	28.0	6
ST62308SC	#1	100.0	190.0	28.0	6
ST62309SC	#1	150.0	240.0	28.0	6
ST62310SC	#1	200.0	288.0	28.0	6
ST62311SC	#2	38.0	99.0	35.0	6
ST62312SC	#2	100.0	202.0	32.0	6
ST62313SC	#2	150.0	250.0	32.0	6
ST62314SC	#2	200.0	312.0	32.0	6
ST62315SC	#2	250.0	325.0	32.0	6
ST62316SC	#3	150.0	260.0	35.0	6
ST62317SC	#3	200.0	312.0	35.0	6

Acetate Screwdriver Torx®

- Blade is made of high performance alloy steel for maximum strength and durability
- Ergonomic acetate handle provides increased comfort and maximized torque
- 100% solid impact resistant acetate handle for lasting durability
- Oil and solvent resistant handle provides a longer tool life
- Handle designed with "through hole" for easy storage
- Tempered steel construction offers strength and durability for long-lasting performance
- Meets or exceeds Camcar TXF-705



Article Code	Size	Shank Length (mm)	Overall Length (mm)	Handle Diameter (mm)	
ST61108SC	T8	75.0	147.0	23.0	6
ST61101SC	T10	100.0	190.0	28.0	6
ST61102SC	T15	100.0	190.0	28.0	6
ST61103SC	T20	100.0	190.0	28.0	6
ST61104SC	T25	100.0	312.0	32.0	6
ST61105SC	T27	100.0	202.0	32.0	6
ST61106SC	T30	100.0	202.0	32.0	6
ST61107SC	T40	100.0	212.0	35.0	6

Nut Driver

- Ergonomic acetate handle provides increased comfort and maximized torque
- 100% solid impact resistant acetate handle for lasting durability
- Oil and solvent resistant handle provides a longer tool life
- Handle designed with "through hole" for easy storage



Article Code	Size (mm)	Shank Length (mm)	Overall Length (mm)	Handle Diameter (mm)	
ST61503SC	7.0	75.0	178.0	23.0	12
ST61504SC	8.0	75.0	178.0	23.0	12
ST61505SC	9.0	75.0	178.0	23.0	12
ST61506SC	10.0	75.0	190.0	23.0	6
ST61507SC	11.0	75.0	190.0	23.0	6
ST61508SC	12.0	75.0	190.0	23.0	6

1/4" Drive Magnetic Bit Driver

- Magnetic bit holder for fastener retention
- Ergonomic acetate handles provide increased comfort and maximized torque
- 100% solid impact resistant acetate handle for lasting durability
- Oil and solvent resistant handle provides a longer tool life
- Handle designed with "through hole" for easy storage
- Meets or exceeds ASME B107.110



Article Code	Size	Shank Length (mm)	Overall Length (mm)	Handle Diameter (mm)	
ST61002SC	1/4"	100.0	212.0	35.0	6

6 Pc. Dual Material Soft Grip Combination Screwdriver Set

Article Code	Content	
ST09309SJ	3 - Dual Material Soft Grip Screwdrivers Phillips #1x75 mm, #2x100 mm, #2x150 mm 3 - Dual Material Soft Grip Screwdrivers Slotted 5x75 mm, 5x100 mm, 6x150 mm	6



Dual Material Soft Grip Screwdriver Slotted

- Blade is made of high performance alloy steel for maximum strength and durability
- High-impact, dual material soft grip handle presents an ergonomic and strong grip
- Sleek handle design for maximum power, user comfort, and greater access
- Oil and solvent resistant handle provides a longer tool life
- Chrome vanadium alloy steel (Cr-V) for exceptional strength and durability
- Meets or exceeds ASME B107.600



Article Code	Size (mm)	Shank Length (mm)	Overall Length (mm)	Handle Diameter (mm)	
ST63402SC	3.2	75.0	160.0	25.0	6
ST63403SC	3.2	100.0	185.0	25.0	6
ST63404SC	3.2	150.0	235.0	25.0	6
ST63405SC	3.2	200.0	286.0	25.0	6
ST63407SC	5.0	75.0	180.0	31.0	6
ST63408SC	5.0	100.0	205.0	31.0	6
ST63409SC	5.0	150.0	255.0	31.0	6
ST63410SC	5.0	200.0	306.0	31.0	6
ST63411SC	6.0	38.0	98.0	37.0	6
ST63412SC	6.0	100.0	217.0	35.0	6
ST63413SC	6.0	150.0	267.0	35.0	6
ST63414SC	6.0	200.0	317.0	35.0	6
ST63415SC	6.0	250.0	367.0	35.0	6
ST63416SC	8.0	150.0	276.0	38.0	6
ST63417SC	8.0	200.0	326.0	38.0	6

Dual Material Soft Grip Screwdriver Phillips

- Blade is made of high performance alloy steel for maximum strength and durability
- High-impact, dual material soft grip handle presents an ergonomic and strong grip
- Sleek handle design for maximum power, user comfort, and greater access
- Oil and solvent resistant handle provides a longer tool life
- Chrome vanadium alloy steel (Cr-V) for exceptional strength and durability
- Meets or exceeds ASME B107.600



Article Code	Size	Shank Length (mm)	Overall Length (mm)	Handle Diameter (mm)	
ST63502SC	#0	75.0	160.0	25.0	6
ST63503SC	#0	100.0	185.0	25.0	6
ST63504SC	#0	150.0	235.0	25.0	6
ST63505SC	#0	200.0	286.0	25.0	6
ST63507SC	#1	75.0	180.0	31.0	6
ST63508SC	#1	100.0	205.0	31.0	6
ST63509SC	#1	150.0	255.0	31.0	6
ST63510SC	#1	200.0	305.0	31.0	6
ST63511SC	#2	38.0	98.0	37.0	6
ST63512SC	#2	100.0	217.0	35.0	6
ST63513SC	#2	150.0	267.0	35.0	6
ST63514SC	#2	200.0	317.0	35.0	6
ST63515SC	#2	250.0	367.0	35.0	6
ST63516SC	#3	150.0	276.0	38.0	6
ST63517SC	#3	200.0	326.0	38.0	6

Dual Material Soft Grip Reversible Screwdriver

- Blade is made of high performance alloy steel for maximum strength and durability
- Reversible tip for Phillips and Slotted applications
- High-impact, dual material soft grip handle presents an ergonomic and strong grip
- Sleek handle design for maximum power, user comfort, and greater access
- Oil and solvent resistant handle provides a longer tool life
- Chrome vanadium alloy steel (Cr-V) for exceptional strength and durability
- Meets or exceeds ASME B107.600



 Nature of this product is subject to wear and tear upon usage. Not covered under Lifetime Warranty.

Article Code	Size	Shank Length (mm)	Overall Length (mm)	Handle Diameter (mm)	
ST66202SC	#2x6.0 mm	38.0	98.0	37.0	6
ST66203SC	#1x5.0 mm	100.0	220.0	35.0	6
ST66204SC	#2x6.0 mm	100.0	220.0	35.0	6
ST66205SC	#1x5.0 mm	150.0	270.0	35.0	6
ST66206SC	#2x6.0 mm	150.0	270.0	35.0	6

Dual Material Soft Grip Go-Through Screwdriver Slotted

- Blade is made of high performance alloy steel for maximum strength and durability
- Through-metal shaft and cap for striking
- High-impact, dual material soft grip handle presents an ergonomic and strong grip
- Sleek handle design for maximum power, user comfort, and greater access
- Oil and solvent resistant handle provides a longer tool life
- Chrome vanadium alloy steel (Cr-V) for exceptional strength and durability
- Meets or exceeds ASME B107.600



Article Code	Size (mm)	Shank Length (mm)	Overall Length (mm)	Handle Diameter (mm)	
ST61603SC	6.0	100.0	220.0	34.0	6
ST61605SC	6.0	150.0	269.0	34.0	6
ST61606SC	8.0	150.0	280.0	38.0	6
ST61607SC	8.0	200.0	330.0	38.0	6
ST61608SC	8.0	250.0	380.0	38.0	6

Dual Material Soft Grip Go-Through Screwdriver Phillips

- Blade is made of high performance alloy steel for maximum strength and durability
- Through-metal shaft and cap for striking
- High-impact, dual material soft grip handle presents an ergonomic and strong grip
- Sleek handle design for maximum power, user comfort, and greater access
- Oil and solvent resistant handle provides a longer tool life
- Chrome vanadium alloy steel (Cr-V) for exceptional strength and durability
- Meets or exceeds ASME B107.600



Article Code	Size	Shank Length (mm)	Overall Length (mm)	Handle Diameter (mm)	
ST61703SC	#2	100.0	220.0	34.0	6
ST61705SC	#2	150.0	269.0	34.0	6
ST61706SC	#3	150.0	280.0	38.0	6
ST61707SC	#3	200.0	330.0	38.0	6
ST61708SC	#3	250.0	380.0	38.0	6

5 Pc. T-Series VDE Insulated Screwdriver Set



Article Code	Content	
ST09302U	2 - VDE Insulated Screwdrivers Slotted 3,0 x 100 mm, 5,5 x 125 mm 2 - VDE Insulated Screwdrivers Phillips 1 x 80 mm, 2 x 100 mm 1 - Circuit Tester	6



7 Pc. T-Series VDE Insulated Screwdriver Set



Article Code	Content	
ST09303	3 - VDE Insulated Screwdrivers Phillips #0 x 60 mm, #1 x 80 mm, #2 x 100 mm 4 - VDE Insulated Screwdrivers Slotted 2,5 x 75 mm, 4 x 100 mm, 5,5 x 125 mm, 6,5 x 150 mm	10





T-Series VDE Insulated Screwdrivers - Slotted

- VDE Certified
- For use in high voltage areas, up to 1000 V alternating current
- Blade is made of high performance alloy steel for maximum strength and durability
- High-impact, contoured handle presents an ergonomic and strong grip
- Sleek handle design for maximum power, user comfort, and greater access
- Oil and solvent resistant handle provides a longer tool life
- Handle designed with "through hole" for easy storage



Article Code	Size (mm)	Shank Length (mm)	Overall Length (mm)	Handle Diameter (mm)	
ST61321SC	2.5	75.0	163.0	25.0	12
ST61322SC	3.0	100.0	187.0	25.0	12
ST61323SC	4.0	100.0	205.0	31.0	12
ST61324SC	5.5	125.0	245.0	35.0	12
ST61325SC	6.5	150.0	270.0	35.0	12



T-Series VDE Insulated Screwdrivers - Phillips

- VDE Certified
- For use in high voltage areas, up to 1000 V alternating current
- Blade is made of high performance alloy steel for maximum strength and durability
- High-impact, contoured handle presents an ergonomic and strong grip
- Sleek handle design for maximum power, user comfort, and greater access
- Oil and solvent resistant handle provides a longer tool life
- Handle designed with "through hole" for easy storage



Article Code	Size	Shank Length (mm)	Overall Length (mm)	Handle Diameter (mm)	
ST61221SC	#0	60.0	147.0	25.0	12
ST61222SC	#1	80.0	188.0	31.0	12
ST61223SC	#2	100.0	220.0	35.0	12
ST61224SC	#3	150.0	280.0	38.0	6

G-Series VDE Insulated Screwdrivers - Slotted



- VDE Certified
- For use in high voltage areas, up to 1000 V alternating current
- Blade is made of high performance alloy steel for maximum strength and durability
- High-impact, contoured handle presents an ergonomic and strong grip
- Sleek handle design for maximum power, user comfort, and greater access
- Oil and solvent resistant handle provides a longer tool life
- Handle designed with "through hole" for easy storage
- Made in Germany



Article Code	Size (mm)	Shank Length (mm)	Overall Length (mm)	Handle Diameter (mm)	
ST61311SC	2.5	75.0	163.0	25.0	6
ST61312SC	3.0	100.0	188.0	25.0	6
ST61313SC	4.0	100.0	208.0	25.0	6
ST61314SC	5.5	125.0	233.0	34.0	6
ST61315SC	6.5	150.0	258.0	34.0	6

G-Series VDE Insulated Screwdrivers - Phillips



- VDE Certified
- For use in high voltage areas, up to 1000 V alternating current
- Blade is made of high performance alloy steel for maximum strength and durability
- High-impact, contoured handle presents an ergonomic and strong grip
- Sleek handle design for maximum power, user comfort, and greater access
- Oil and solvent resistant handle provides a longer tool life
- Handle designed with "through hole" for easy storage
- Made in Germany



Article Code	Size	Shank Length (mm)	Overall Length (mm)	Handle Diameter (mm)	
ST61211SC	#0	60.0	148.0	25.0	6
ST61212SC	#1	80.0	188.0	25.0	6
ST61213SC	#2	100.0	208.0	34.0	6
ST61214SC	#3	150.0	270.0	37.0	6

6-in-1 Interchangeable Screwdriver Set

Article Code	Content	
ST09347	1- Screwdriver handle (5/16" and 1/4" double ended shank) 2- 75 mm double ended bits 5/16" - 6.0 mm x #2 (Slotted / Phillips) 1/4" - 5.0 mm x #1 (Slotted / Phillips)	6



8 Pc. Impact Screwdriver Set

Article Code	Content	
ST09602SJ	1- Impact Screwdriver 1- 1/2" Drive Bit Adapter 4- 5/16" Shank 30L Bits Slotted 8.0, 10.0 mm; Phillips #2, #3 2- 5/16" Shank 70L Bits Slotted 8.0 mm; Phillips #2	12

 Nature of this product is subject to wear and tear upon usage. Not covered under Lifetime Warranty.



8 Pc. Impact Screwdriver Set

Article Code	Content	
ST09603SJ	1- Protective Grip Impact Screwdriver 1- 1/2" Drive Bit Adapter 4- 5/16" Shank 30L Bits Slotted 8.0, 10.0 mm; Phillips #2, #3 2- 5/16" Shank 70L Bits Slotted 8.0 mm; Phillips #2	12

 Nature of this product is subject to wear and tear upon usage. Not covered under Lifetime Warranty.



24 Pc. Ratcheting T-Handle Screwdriver Set

Article Code	Content	
ST09341SJ	1- T-Handle Ratcheting Screwdriver 1- 1/4" x 1/4" Dr. Extension Bar 6" 1- 1/4" x 1/4" Dr. Flex Extension Bar 6" 1- 1/4" Dr. Bit Adapter 20- Bits Phillips #0, #1, #2, #3 Slotted 3, 4, 5, 5.5, 6.5, 8 mm, T10, T15, T20, T25, Hex 2.5, 3, 4, 5, 6, 7 mm	8

 Please refer to the warranty terms of the individual product



25 Pc. Ratcheting Stubby Screwdriver Set

Article Code	Content	
ST09342SJ	1 - Stubby Ratcheting Screwdriver 1 - Magnetic Bit Holder 3-1/2" 1 - 1/4" x 1/4" Dr. Extension Bar 3-1/2" 1 - 1/4" x 1/4" Dr. Flex Extension Bar 6" 1 - 1/4" Dr. Bit Adapter 20 - Bits Phillips #0, #1, #2, #3, Slotted 3, 4, 5, 5.5, 6.5, 8 mm, T10, T15, T20, T25, Hex 2.5, 3, 4, 5, 6, 7 mm	8

 Please refer to the warranty terms of the individual product



26 Pc. Ratcheting Screwdriver Set

Article Code	Content	
ST09343SJ	1 - Standard Ratcheting Screwdriver 3 - 1/4" x 1/4" Dr. Extension Bars 3-1/2", 6", 10" 1 - 1/4" x 1/4" Dr. Flex Extension 6" 1 - 1/4" Dr. Bit Adapter 20 - Bits Phillips #0, #1, #2, #3, Slotted 3, 4, 5, 5.5, 6.5, 8 mm, T10, T15, T20, T25, Hex 2.5, 3, 4, 5, 6, 7 mm	6

 Please refer to the warranty terms of the individual product



6 Pc. Stubby Ratcheting Screwdriver Set

Article Code	Content	
ST09348	1 - Stubby Ratcheting Screwdriver 6 - Bits Phillips #1, #2, #3, Slotted 4.0, 5.0, 6.0 mm	6



19-in-1 Multipurpose Ratcheting Screwdriver Set

Article Code	Content	
ST09350	1 - Ratcheting Screwdriver 8 - Double-sided Bits Phillips #1, #2, #3 Slotted 5.0, 6.0, 8.0 mm Torx® T15, T20, T25, T20 Hex 2.0, 2.5, 3.0, 4.0, 5.0, 6.0 mm	10



60 PC. & 80 PC. RATCHETING BIT DRIVER SET

ST09324SJ
ST09326SJ

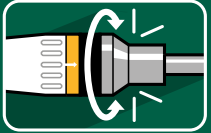

Designed with ratcheting function

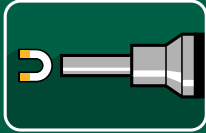

Magnetic bit holder



Shank is made of high performance alloy steel

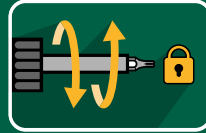

Forward and reversible locking position



Ergonomic dual material



Comes with a durable blow mold case



60 Pc. 1/4" Drive 6 Point Metric Socket and Ratcheting Bit Driver Set

Article Code	Content	
ST09324SJ	1 - Ratcheting Bit Driver 14 - 6pt. Metric Sockets 3.5, 4, 4.5, 5, 5.5, 6, 7, 8, 9, 10, 11, 12, 13, 14 mm 28 - 25L Bits Phillips #0, #1, #2, #3 Slotted 3, 4, 5.5, 6.5 mm Hex 2, 2.5, 3, 4, 5, 6 mm Torx® T10, T15, T20, T25, T27, T30, T40 Tamper-Proof Torx® T10, T15, T20, T25, T27, T30, T40 12 - 50L Bits Phillips #1, #2, #3 Slotted 4, 5.5, 6.5 mm Hex 4, 5, 6 mm Torx® T15, T20, T25 5 - Accessories 25L Socket Bit Adapter 50L Socket Bit Adapter Magnetic Bit Holder 60 mm Flex Extension Bar 6" Bit Adapter	6



80 Pc. Ratcheting Bit Driver Set

Article Code	Content	
ST09326SJ	1 - Ratcheting Bit Driver 33 - 25L Bits Phillips #0, #1, #2(2x), #3 Slotted 3, 4, 5, 5.5, 6, 6.5 mm Hex 2, 2.5, 3, 4, 5, 6 mm Torx® T8, T10, T15, T20, T25, T27, T30, T40 Tamper-Proof Torx® T8, T10, T15, T20, T25, T27, T30, T40 32 - 50L Bits Phillips #0, #1, #2, #3 Slotted 3, 4, 5, 5.5, 6, 6.5 mm Hex 2, 2.5, 3, 4, 5, 6 mm Torx® T8, T10, T15, T20, T25, T27, T30, T40 Tamper-Proof Torx® T8, T10, T15, T20, T25, T27, T30, T40 8 - 65L Double End Bits PH1-PH1, PH2-PH2, PH3-PH3, 4.5 mm-PH1, 5.5 mm-PH2, 6.5 mm-PH3, PH1-PH2, PH2-PH3 3 - 110L Double End Bits PH1-PH1, PH2-PH2, PH3-PH3 3 - Accessories 25 L Socket Bit Adapter 50 L Socket Bit Adapter Magnetic Bit Holder 60 mm	12



6 Pc. Mini Screwdriver Set

Article Code	Content	
ST03141ST	3 - Phillips #00, #0, #1 3 - Slotted 1.6 mm, 2.0 mm, 2.4 mm	10

6 Pc. Mini Screwdriver Set

Article Code	Content	
ST03142	2 - Phillips #00, #0 4 - Torx® T5, T6, T7, T8	10



6 Pc. Precision Slotted Screwdriver Set

Article Code	Content	
ST09311SJ	6 - Slotted 1.0x40 mm, 1.4x50 mm, 2.0x50 mm, 2.4x50 mm, 3.0x50 mm, 3.5x50 mm	6

6 Pc. Precision Combination Screwdriver Set

Article Code	Content	
ST09312SJ	2 - Phillips #0x50 mm, #00x50 mm 4 - Slotted 1.4x50 mm, 2.0x50 mm, 2.4x50 mm, 3.0x50 mm	6



7 Pc. Precision Combination Screwdriver Set

Article Code	Content	
ST09314SJ	3 - Phillips #000x40 mm, #00x50 mm, #0x50 mm 4 - Slotted 14x50 mm, 2.0x50 mm, 24x50 mm, 3.0x50 mm	6



9 Pc. Precision Combination Screwdriver Set

Article Code	Content	
ST09316SJ	4 - Phillips #000x40 mm, #00x75 mm, #0x75 mm, #1x100 mm 5 - Slotted 1.0x40 mm, 2.0x50 mm, 24x75 mm, 3.0x75 mm, 4.0x100 mm	6



15 Pc. Precision Combination Screwdriver Set

Article Code	Content	
ST09317SJ	3 - Phillips #000x40 mm, #00x50 mm, #0x50 mm 4 - Slotted 1.0x40 mm, 2.0x50 mm, 3.0x50 mm, 3.5x50 mm 4 - Torx® T6x50 mm, T8x50 mm, T10x50 mm, T15x50 mm 4 - Hex 1.5x50 mm, 2.0x50 mm, 2.5x50 mm, 3.0x50 mm	6



6 Pc. Precision Torx® Screwdriver Set

Article Code	Content	
ST09313SJ	6 - Torx® T6x50 mm, T7x50 mm, T8x50 mm, T9x50 mm, T10x50 mm, T15x50 mm	6



7 Pc. Precision Torx® Screwdriver Set 31 Pc. 1/4" Drive Bit Set

Article Code	Content	
ST09315SJ	7 - Torx® T5x50 mm, T6x50 mm, T7x50 mm, T8x50 mm, T9x50 mm, T10x50 mm, T15x50 mm	6





Article Code	Content	
ST09332SJ	1 - Magnetic Bit Holder 30 - 1/4" Shank 25L Bits Slotted 4, 5, 6, 6.5 mm Phillips #0, #1, #2, #3 Hex 3, 4, 5, 6, 7, 8 mm Torx® T8, T10, T15, T20, T25, T30, T40 Tamper-Proof Torx® T10, T15, T20, T25, T30, T40 Pozidriv #1, #2, #3	6

 Please refer to the warranty terms of the individual product



31 Pc. 1/4" Drive Bit Set

Article Code	Content	
ST09333SJ	1 - Magnetic Quick-Change Bit Holder 30 - 1/4" Shank 25L Bits Slotted 4, 5.5, 6, 6.5 mm Phillips #0, #1, #2, #3 Hex 3, 4, 5, 6, 7, 8 mm Torx® T8, T10, T15, T20, T25, T30, T40 Tamper-Proof Torx® T10, T15, T20, T25, T30, T40 Pozidriv #1, #2, #3	6

 Please refer to the warranty terms of the individual product



31 PC. 1/4" DRIVE BIT SET

ST09332SJ
ST09333SJ



30 Precision bits

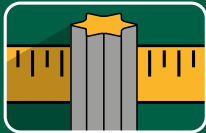

Precision
engineered

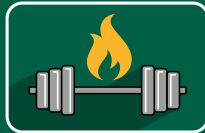

Heat treated

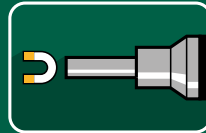

Magnetic bit
holder

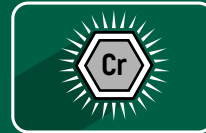

Full polish
chrome finish

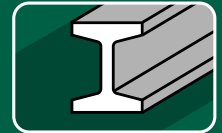

Bits are made of
high performance
alloy steel

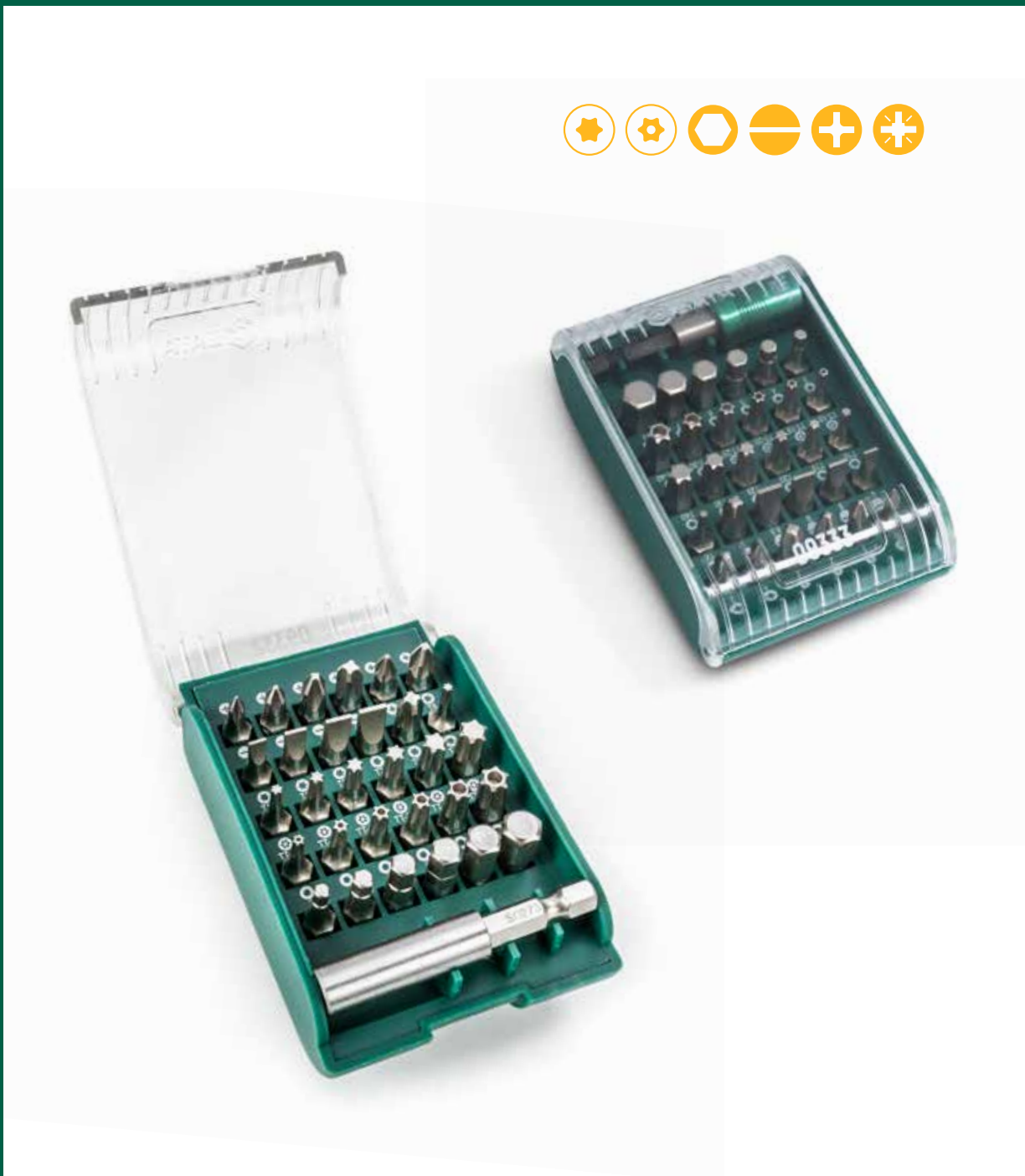

1/4" Drive Magnetic Bit Holder

- Magnetic, easy to operate
- Manufactured from S2 steel for maximum strength and durability
- 3 Pc. display packed



 Excluded from Lifetime Warranty terms

Article Code	Size	Overall Length (mm)	
ST59273ST	1/4"	60.0	12

1/4" Drive Magnetic Quick-Change Bit Holder

- Magnetic, easy to operate
- One-hand operation for faster bit changes
- Manufactured from S2 steel for maximum strength and durability
- For use with impact drivers



 Excluded from Lifetime Warranty terms

Article Code	Size	Overall Length (mm)	
ST59274	1/4"	64.0	6

1/4" Drive Socket Bit Adapter

- Manufactured from S2 steel for maximum strength and durability
- 5 Pc. display packed



ST59271ST



ST59272ST

 Excluded from Lifetime Warranty terms

Article Code	Size	Overall Length (mm)	
ST59271ST	1/4"	25.0	12
ST59272ST	1/4"	50.0	12

1/4" Dr. 25L Bit Phillips

- Precision engineered bits for a better fit on fasteners
- Heat treated for long lasting durability
- S2 steel insert bits offer maximum strength and durability
- 5 Pc. display packed
- Meets or exceeds ASME B107.600

 Excluded from Lifetime Warranty terms



Article Code	Size	Overall Length (mm)	
SC59221	#0	25.0	12
SC59222	#1	25.0	12
SC59223	#2	25.0	12
SC59224	#3	25.0	12

1/4" Dr. 25L Bit Pozidriv

- Precision engineered bits for a better fit on fasteners
- Heat treated for long lasting durability
- S2 steel insert bits offer maximum strength and durability
- 5 Pc. display packed
- Meets or exceeds ASME B107.600

 Excluded from Lifetime Warranty terms



Article Code	Size	Overall Length (mm)	
SC59261	#1	25.0	12
SC59262	#2	25.0	12
SC59263	#3	25.0	12

1/4" Drive 25L Bit Slotted

- Precision engineered bits for a better fit on fasteners
- Heat treated for long lasting durability
- S2 steel insert bits offer maximum strength and durability
- 5 Pc. display packed
- Meets or exceeds ASME B107.600

 Excluded from Lifetime Warranty terms





Article Code	Size (mm)	Overall Length (mm)	
SC59211	3.0	25.0	12
SC59213	4.0	25.0	12
SC59215	5.0	25.0	12
SC59216	5.5	25.0	12
SC59217	6.0	25.0	12
SC59218	6.5	25.0	12

1/4" Drive 25L Bit Torx®

- Precision engineered bits for a better fit on fasteners
- Heat treated for long lasting durability
- S2 steel insert bits offer maximum strength and durability
- 5 Pc. display packed
- Meets or exceeds Camcar TXF-702



 Excluded from Lifetime Warranty terms

Article Code	Size	Overall Length (mm)	
SC59231	T8	25.0	12
SC59232	T10	25.0	12
SC59233	T15	25.0	12
SC59234	T20	25.0	12
SC59235	T25	25.0	12
SC59236	T27	25.0	12
SC59237	T30	25.0	12
SC59238	T40	25.0	12

1/4" Drive 25L Bit Hex

- Precision engineered bits for a better fit on fasteners
- Heat treated for long lasting durability
- S2 steel insert bits offer maximum strength and durability
- 5 Pc. display packed
- Meets or exceeds ASME B18.3.2M



 Excluded from Lifetime Warranty terms

Article Code	Size (mm)	Overall Length (mm)	
SC59251	2.0	25.0	12
SC59253	3.0	25.0	12
SC59254	4.0	25.0	12
SC59255	5.0	25.0	12
SC59256	6.0	25.0	12
SC59257	7.0	25.0	12
SC59258	8.0	25.0	12

5/16" Drive 30L Bit Slotted

- Precision engineered bits for a better fit on fasteners
- Heat treated for long lasting durability
- S2 steel insert bits offer maximum strength and durability
- 5 Pc. display packed
- Meets or exceeds ASME B18.3.2M

 Excluded from Lifetime Warranty terms



Article Code	Size (mm)	Overall Length (mm)	
SC59415	8.0	30.0	12
SC59416	10.0	30.0	12
SC59417	12.0	30.0	12

5/16" Drive 30L Bit Philips

- Precision engineered bits for a better fit on fasteners
- Heat treated for long lasting durability
- S2 steel insert bits offer maximum strength and durability
- 5 Pc. display packed
- Meets or exceeds ASME B18.3.2M

 Excluded from Lifetime Warranty terms



Article Code	Size	Overall Length (mm)	
SC59421	#1	30.0	12
SC59422	#2	30.0	12
SC59423	#3	30.0	12
SC59424	#4	30.0	12

5/16" Drive 30L Bit Hex

- Precision engineered bits for a better fit on fasteners
- Heat treated for long lasting durability
- S2 steel insert bits offer maximum strength and durability
- 5 Pc. display packed
- Meets or exceeds ASME B18.3.2M

 Excluded from Lifetime Warranty terms



Article Code	Size (mm)	Overall Length (mm)	
SC59471	4.0	30.0	12
SC59472	5.0	30.0	12
SC59473	6.0	30.0	12
SC59474	8.0	30.0	12
SC59475	10.0	30.0	12
SC59476	12.0	30.0	12

Hex Keys



9 Pc. Metric Extra Long Ball Point Hex Key and Torque Handle Set

Article Code	Content	
ST09124SJ	1.5, 2, 2.5, 3, 4, 5, 6, 8, 10 mm	6



9 PC. METRIC EXTRA LONG BALL POINT HEX KEY AND TORQUE HANDLE SET

ST09124SJ

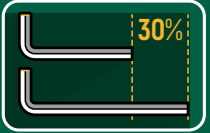

Up to 30% longer



Angled access
to fasteners



Precise fit

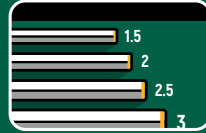

Easy to read
size markings



High-torque
handle

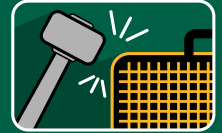

Impact resistant
caddy



METRIC



9 Pc. Metric Extra Long Ball Point Hex Key Set

Article Code	Content	
ST09101ASJ	1.5, 2, 2.5, 3, 4, 5, 6, 8, 10 mm	6



12 Pc. SAE Extra Long Ball Point Hex Key Set

Article Code	Content	
ST09102SJ	1/16, 5/64, 3/32, 7/64, 1/8, 9/64, 5/32, 3/16, 7/32, 1/4, 5/16, 3/8"	6



Extra Long Ball Point Hex Key

- Up to 30% longer for improved access and leverage
- Ball point keys allow for angled access to fasteners
- Precise fit for a solid grip and chamfered tips for faster insertion
- Easy to read size markings
- Chrome vanadium alloy steel (Cr-V) for exceptional strength and durability
- Meets or exceeds ASME B18.3.2M



Article Code	Size (mm)	Long End Length (mm)	Short End Length (mm)	
SC80104	1.5	89.0	13.0	72
SC80105	2.0	99.0	13.5	72
SC80106A	2.5	111.0	17.0	72
SC80107A	3.0	125.0	19.0	36
SC80108A	4.0	139.0	24.0	36
SC80110A	5.0	159.0	27.0	36
SC80112A	6.0	179.0	31.0	36
SC80114A	8.0	199.0	35.0	18
SC80116A	10.0	223.0	39.0	18

9 Pc. Metric Extra Long Hex Key Set

12 Pc. SAE Extra Long Hex Key Set

Article Code	Content	
ST09103ASJ	1.5, 2, 2.5, 3, 4, 5, 6, 8, 10 mm	6

Article Code	Content	
ST09104SJ	1/16, 5/64, 3/32, 7/64, 1/8, 9/64, 5/32, 3/16, 7/32, 1/4, 5/16, 3/8"	6



Extra Long Hex Key

- Up to 30% longer for improved access and leverage
- Precise fit for a solid grip and chamfered tips for faster insertion
- Easy to read size markings
- Chrome vanadium alloy steel (Cr-V) for exceptional strength and durability
- Meets or exceeds ASME B18.3.2M



Article Code	Size (mm)	Long End Length (mm)	Short End Length (mm)	
SC80304	1.5	89.0	13.0	72
SC80305	2.0	99.0	13.5	72
SC80306	2.5	111.0	17.0	72
SC80307	3.0	125.0	19.0	36
SC80308	4.0	139.0	24.0	36
SC80310	5.0	159.0	27.0	36
SC80312	6.0	179.0	31.0	36
SC80314	8.0	199.0	35.0	18
SC80316	10.0	223.0	39.0	18

9 Pc. Metric Long Ball Point Hex Key Set

Article Code	Content	
ST09105ASJ	1.5, 2, 2.5, 3, 4, 5, 6, 8, 10 mm	6



12 Pc. SAE Long Ball Point Hex Key Set

Article Code	Content	
ST09106SJ	1/16, 5/64, 3/32, 7/64, 1/8, 9/64, 5/32, 3/16, 7/32, 1/4, 5/16, 3/8"	6



Long Ball Point Hex Key

- Ball point keys allow for angled access to fasteners
- Precise fit for a solid grip and chamfered tips for faster insertion
- Easy to read size markings
- Chrome vanadium alloy steel (Cr-V) for exceptional strength and durability
- Meets or exceeds ASME B18.3.2M



Article Code	Size (mm)	Long End Length (mm)	Short End Length (mm)	
SC81104	1.5	77.0	13.5	72
SC81105	2.0	82.0	15.5	72
SC81106A	2.5	88.5	17.5	72
SC81107A	3.0	98.5	19.0	36
SC81108	4.0	104.0	24.0	36
SC81110A	5.0	116.0	27.0	36
SC81111	5.5	126.5	29.0	36
SC81112A	6.0	138.0	31.0	36
SC81113A	7.0	148.0	33.0	36
SC81114A	8.0	175.5	35.0	18
SC81116A	10.0	167.0	39.0	18

9 Pc. Metric Long Hex Key Set

Article Code	Content	
ST09107ASJ	1.5, 2, 2.5, 3, 4, 5, 6, 8, 10 mm	6



12 Pc. SAE Long Hex Key Set

Article Code	Content	
ST09108SJ	1/16, 5/64, 3/32, 7/64, 1/8, 9/64, 5/32, 3/16, 7/32, 1/4, 5/16, 3/8"	6



Long Hex Key

- Precise fit for a solid grip and chamfered tips for faster insertion
- Easy to read size markings
- Chrome vanadium alloy steel (Cr-V) for exceptional strength and durability
- Meets or exceeds ASME B18.3.2M



Article Code	Size (mm)	Long End Length (mm)	Short End Length (mm)	
SC81304	1.5	77.0	13.5	72
SC81305	2.0	82.0	15.5	72
SC81306	2.5	88.5	17.5	72
SC81307	3.0	98.5	19.0	36
SC81308A	4.0	104.0	24.0	36
SC81310	5.0	116.0	27.0	36
SC81312	6.0	138.0	31.0	36
SC81314	8.0	157.5	35.0	18
SC81316	10.0	167.0	39.0	18

8 Pc. Metric Hex Key Fold-Up Set

Article Code	Content	
ST09121SJ	1.5, 2, 2.5, 3, 4, 5, 6, 8 mm	12

9 Pc. SAE Hex Key Fold-Up Set

Article Code	Content	
ST09122SJ	5/64, 3/32, 7/64, 1/8, 9/64, 5/32, 3/16, 7/32, 1/4"	12

8 Pc. Torx® Key Fold-Up Set

Article Code	Content	
ST09123SJ	T9, T10, T15, T20, T25, T27, T30, T40	12



T-Handle Ball Point Hex Key

- Ball point keys allow for angled access to fasteners
- Precise fit for a solid grip and chamfered tips for faster insertion
- Easy to read size markings
- Ergonomic non-slip grip delivers superior strength and ultimate comfort in use
- Key made of shock resisted steel (SVCN+) material to provide 30% more torque than Chrome vanadium alloy steel (Cr-V)
- Meets or exceeds ASME B18.3.2M



Article Code	Size (mm)	Handle Length (mm)	Overall Length (mm)	
ST83105SC	2.0	61.5	129.0	6
ST83106SC	2.5	61.5	129.0	6
ST83107SC	3.0	61.0	128.5	6
ST83108SC	4.0	60.5	178.0	6
ST83110SC	5.0	64.0	178.0	6
ST83112SC	6.0	88.0	192.0	6
ST83113SC	7.0	87.5	241.5	6
ST83114SC	8.0	87.5	241.5	6
ST83116SC	10.0	91.0	241.5	6

T-Handle Hex Key

- Precise fit for a solid grip and chamfered tips for faster insertion
- Easy to read size markings
- Ergonomic non-slip grip delivers superior strength and ultimate comfort in use
- Key made of shock resisted steel (SVCM+) material to provide 30% more torque than Chrome vanadium alloy steel (Cr-V)
- Meets or exceeds ASME B18.3.2M



Article Code	Size (mm)	Handle Length (mm)	Overall Length (mm)	
ST83305SC	2.0	61.5	129.0	6
ST83306SC	2.5	61.5	129.0	6
ST83307SC	3.0	61.5	129.0	6
ST83308SC	4.0	60.5	178.0	6
ST83310SC	5.0	64.0	178.0	6
ST83312SC	6.0	88.0	192.0	6
ST83313SC	7.0	87.5	241.5	6
ST83314SC	8.0	87.5	241.5	6
ST83316SC	10.0	91.0	241.5	6

9 Pc. Ball Point Color Series Black Oxide Hex Key Set

Article Code	Content	
ST09101CHBSJ	1.5, 2, 2.5, 3, 4, 5, 6, 8, 10 mm	6



9 Pc. Extra Long Color Series Black Oxide Hex Key Set

Article Code	Content	
ST09107CHBSJ	1.5, 2, 2.5, 3, 4, 5, 6, 8, 10 mm	6



9 PC. BALL POINT & EXTRA LONG COLOR SERIES BLACK OXIDE HEX KEY SET

ST09101CHBSJ
ST09107CHBSJ



Color-coded sleeves



Angled access to fasteners



Precise fit

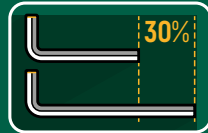

Up to 30% longer



Black oxide finish



Impact resistant caddy



METRIC



Metric/SAE Black Oxide Hex Key Set

Article Code	Content	
ST09120SJ	13 - Long Hex Keys 0.05, 1/16", 5/64", 3/32", 7/64", 1/8", 9/64", 5/32", 3/16", 7/32", 1/4", 5/16", 3/8" 12 - Short Hex Keys 0.7, 0.9, 1.3, 1.5, 2, 2.5, 3, 4, 5, 6, 8, 10 mm	6



8 Pc. Tamper-Proof Torx® Key Set

Article Code	Content	
ST09701	T6, T7, T8, T9, T10, T15, T20, T25	12



Black Oxide Hex Key

- Precise fit for a solid grip and chamfered tips for faster insertion
- Easy to read size markings
- Black oxide finish to resist corrosion
- Chrome vanadium alloy steel (Cr-V) for exceptional strength and durability
- Meets or exceeds ASME B18.3.2M



Article Code	Size (mm)	Long End Length (mm)	Short End Length (mm)	
ST84318SC	12.0	209.0	44.0	10
ST84320SC	14.0	232.5	54.5	10
SC84321	16.0	239.5	58.5	12
ST84323SC	17.0	261.0	64.5	10
SC84322	18.0	246.0	61.5	12
ST84325SC	19.0	275.5	68.5	10
ST84328	22.0	330.0	78.0	10
SC84324	24.0	369.5	88.0	10
SC84329	27.0	410.0	97.5	6

9 Pc. Tamper-Proof Torx® Key Set

Article Code	Content	
ST09702	T10, T15, T20, T25, T27, T30, T40, T45, T50	6



9 Pc. Long Ball Point Tamper-Proof Torx® Key Set

Article Code	Content	
ST09715	T10, T15, T20, T25, T27, T30, T40, T45, T50	6



Tamper-Proof Torx® Key

- Precise fit for a solid grip and chamfered tips for faster insertion
- Easy to read size markings
- Chrome plated finish to resist corrosion
- Manufactured from S2 steel for maximum strength and durability
- Meets or exceeds Camcar TXF-703



Article Code	Size	Long End Length (mm)	Short End Length (mm)	
SC84501	T6	70.0	13.0	72
SC84502	T7	74.0	14.0	72
SC84503	T8	78.0	15.0	72
SC84504	T9	82.0	16.0	72
SC84505	T10	86.0	17.0	72
SC84506	T15	90.0	18.0	72
SC84507	T20	95.0	19.0	72
SC84508	T25	100.0	20.0	72
SC84509	T27	105.0	21.0	72
SC84510	T30	114.0	24.0	72
SC84511	T40	124.0	26.0	72
SC84512	T45	133.0	29.0	36
SC84513	T50	152.0	32.0	36
SC84514	T55	162.0	34.0	36

Striking & Struck

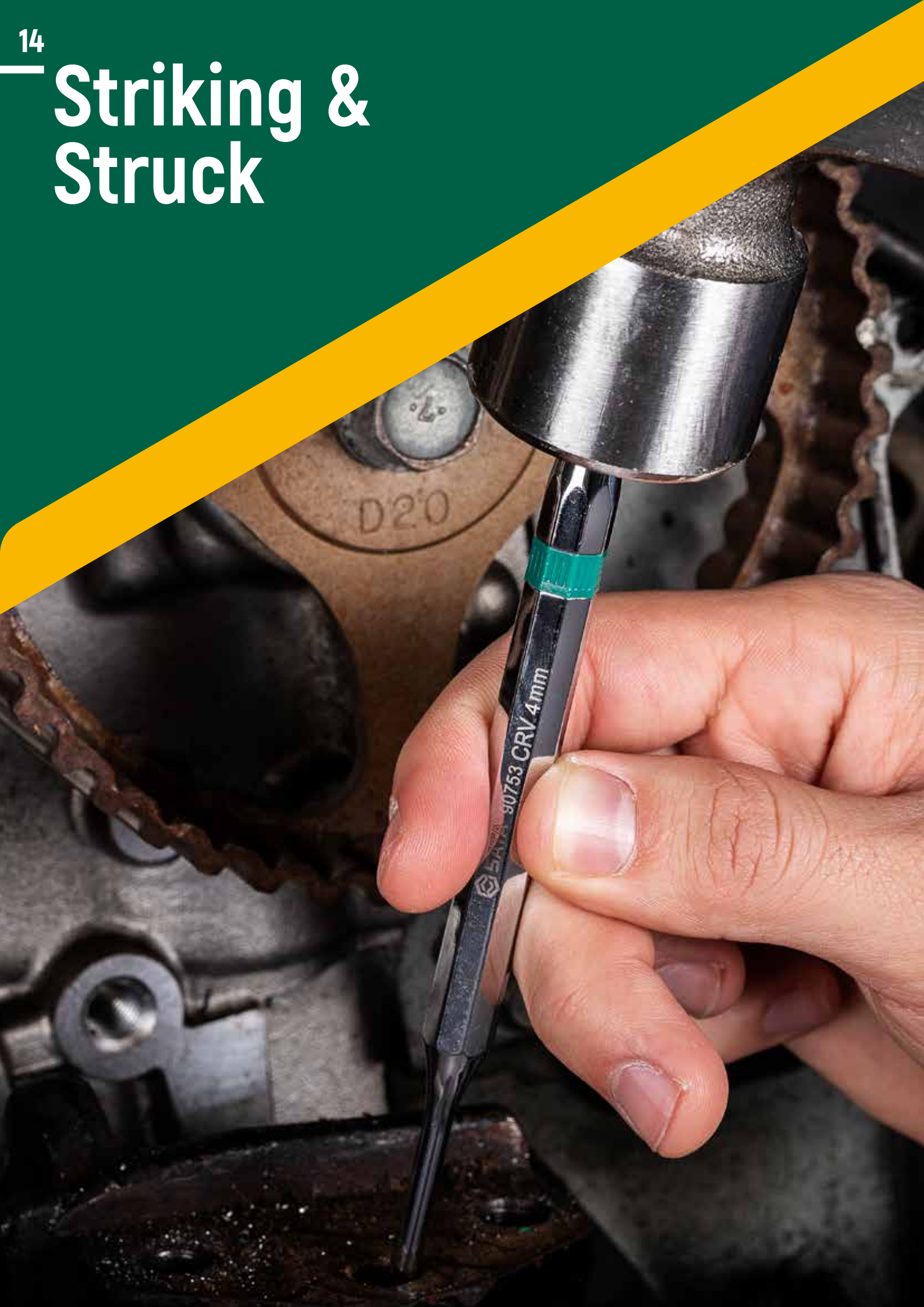

5 Pc. Punch Set

Article Code	Content	
ST09161SJ	1 - Center Punch 4 mm 1 - Drift Punch 3 mm 1 - Pin Punch 4 mm 1 - Cape Chisel 5 mm 1 - Flat Chisel 12 mm	20



6 Pc. Pin Punch Set

Article Code	Content	
ST09162SJ	2, 3, 4, 5, 6, 8 mm	6



3 Pc. Chisel Set

Article Code	Content	
ST09163SJ	20, 22, 25 mm	4



13 Pc. Punch and Chisel Set

Article Code	Content	
ST09164SJ	2 - Center Punches 4, 5 mm 1 - Drift Punch 3 mm 6 - Pin Punches 2, 3, 4, 5, 6, 8 mm 1 - Cape Chisel 5 mm 3 - Flat Chisels 12, 15, 18 mm	4



Center Punch

- Single piece forged steel for maximum strength
- Chrome plated finish to resist corrosion
- Heat treated for long lasting durability
- Bright, full polish chrome finish easily wipes clean
- Chrome vanadium alloy steel (Cr-V) for exceptional strength and durability
- Meets or exceeds ASME B107.410



Article Code	Size (mm)	Tapping Surface Outside Diameter (mm)	Overall Length (mm)	
SC90751	4.0	8.0	120.0	10
ST90762SC	5.0	10.0	150.0	10

Pin Punch

- Single piece forged steel for maximum strength
- Chrome plated finish to resist corrosion
- Heat treated for long lasting durability
- Bright, full polish chrome finish easily wipes clean
- Chrome vanadium alloy steel (Cr-V) for exceptional strength and durability
- Meets or exceeds ASME B107.410



Article Code	Size (mm)	Tapping Surface Outside Diameter (mm)	Overall Length (mm)	
SC90771	2.0	8.0	150.0	10
ST90772SC	3.0	8.0	150.0	10
SC90753	4.0	8.0	150.0	10
SC90774	5.0	8.0	150.0	10
SC90775	6.0	10.0	150.0	10
SC90776	8.0	10.0	150.0	10

Cold Chisel

- Single piece forged steel for maximum strength
- Chrome plated finish (SC90782 & SC90783) and powder coating (SC90784, SC90785 & SC 90786) to resist corrosion
- Heat treated for long lasting durability
- Chrome vanadium alloy steel (Cr-V) for exceptional strength and durability
- Meets or exceeds ASME B107.410

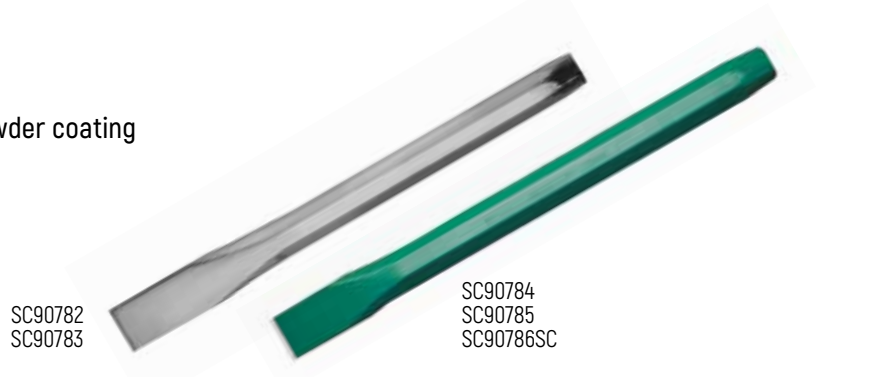

Article Code	Size (mm)	Tapping Surface Outside Diameter (mm)	Overall Length (mm)	
SC90782	15.0	10.0	150.0	10
SC90783	18.0	12.0	175.0	10
SC90784	20.0	14.0	200.0	6
SC90785	22.0	18.0	250.0	6
ST90786SC	25.0	20.0	300.0	4

Hammers

- Durable hickory handle provides comfortable grip
- Unique embedding process to prevent hammer head from easily falling off
- Forging hammer head with quenching treatment to prevent easy broken
- Meets or exceeds ASME B107.410

Standard Bumping Hammer



Article Code	Head Weight (g)	Head Length (mm)	Overall Length (mm)	
ST92101SC	320.0	97.0	330.0	6

Heavy Shrinking Hammer



Article Code	Head Weight (g)	Head Length (mm)	Overall Length (mm)	
ST92102SC	390.0	97.0	330.0	6

Light Shrinking Hammer



Article Code	Head Weight (g)	Head Length (mm)	Overall Length (mm)	
ST92104SC	320.0	97.0	330.0	6

Curved Pein and Finishing Hammer



Article Code	Head Weight (g)	Head Length (mm)	Overall Length (mm)	
ST92103SC	305.0	140.0	330.0	6

Straight Pein and Finishing Hammer



Article Code	Head Weight (g)	Head Length (mm)	Overall Length (mm)	
ST92105SC	305.0	140.0	330.0	6

Pick and Finishing Hammer



Article Code	Head Weight (g)	Head Length (mm)	Overall Length (mm)	
ST92106SC	260.0	137.0	330.0	6

Hickory Ball Pein Hammer

- Maximum-strength head and claw forged of carbon steel, finished with a corrosion and rust resistant clear coat
- Hammer head with polished poles and peins
- Hickory handle is flame treated, clear lacquered, and securely wedged into the hammer's head
- Durable hickory handle provides comfortable grip
- Meets or exceeds ASME B107.410



Article Code	Head Weight (g)	Head Weight (oz)	Overall Length (mm)	
ST92312SC	454.0	16.0	350.0	6
ST92313SC	680.0	24.0	360.0	4
ST92314SC	910.0	32.0	390.0	6
ST92315	1134.0	40.0	400.0	4

Fiberglass Ball Pein Hammer

- Maximum-strength head and claw forged of carbon steel, finished with a corrosion and rust resistant clear coat
- Hammer head with polished poles and peins
- Unique embedded construction securely attaches the head to the handle
- Fiberglass handle absorbs vibration of each strike for comfortable use
- Meets or exceeds ASME B107.410



Article Code	Head Weight (g)	Head Weight (oz)	Overall Length (mm)	
ST92301	227.0	8.0	297.0	4
ST92302SC	454.0	16.0	343.0	2
ST92303SC	680.0	24.0	349.0	2
ST92304SC	910.0	32.0	351.0	2
ST92305	1134.0	40.0	380.0	2

Hickory Claw Hammer

- Maximum-strength head and claw forged of carbon steel, finished with a corrosion and rust resistant clear coat
- Hammer head with polished poles and peins
- Balanced head for maximum striking power and control
- Hickory handle is flame treated, clear lacquered, and securely wedged into the hammer's head
- Durable hickory handle provides comfortable grip
- Rip claws designed for efficient prying and nail pulling
- Meets or exceeds ASME B107.410



Article Code	Head Weight (g)	Head Weight (oz)	Overall Length (mm)	
ST92322SC	370.0	13.0	308.0	6
ST92323SC	454.0	16.0	330.0	6
ST92324SC	567.0	20.0	330.0	6

Fiberglass Claw Hammer

- Maximum-strength head and claw forged of carbon steel, finished with a corrosion and rust resistant clear coat
- Balanced head for maximum striking power and control
- Hammer head with polished poles and peins
- Fiberglass handle absorbs vibration of each strike for comfortable use
- Unique embedded construction securely attaches the head to the handle
- Rip claws designed for efficient prying and nail pulling
- Meets or exceeds ASME B107.410



Article Code	Head Weight (g)	Head Weight (oz)	Overall Length (mm)	
ST92308	227.0	8.0	280.0	4
ST92306SC	454.0	16.0	330.0	2
ST92307SC	680.0	24.0	380.0	2

Hickory Engineers Hammer

- Maximum-strength head and claw forged of carbon steel, finished with a corrosion and rust resistant clear coat
- Balanced head for maximum striking power and control
- Hickory handle is flame treated, clear lacquered, and securely wedged into the hammer's head
- Durable hickory handle provides comfortable grip
- Meets or exceeds ASME B107.410





Article Code	Head Weight (g)	Head Weight (oz)	Overall Length (mm)	
ST92401SC	200.0	7.0	285.0	4
ST92402SC	300.0	10.6	300.0	4
ST92403SC	400.0	14.1	320.0	4
ST92404SC	500.0	17.6	320.0	2
ST92405SC	800.0	28.2	350.0	2
ST92406SC	1000.0	35.5	360.0	2

Hickory Soft Face Hammer

- Non-sparking, non-marring soft face won't harm your target surface
- Aluminum center piece for better balance and lighter weight
- Balanced head for maximum striking power and control
- Hickory handle is flame treated, clear lacquered, and securely wedged into the hammer's head
- Durable hickory handle provides comfortable grip
- Meets or exceeds ASME B107.410



 Plastic hammer head is not covered under Lifetime Warranty.

Article Code	Head Weight (g)	Head Weight (oz)	Head Diameter (mm)	Overall Length (mm)	
ST92501	160.0	5.6	22.0	260.0	6
ST92502SC	162.0	5.7	28.0	303.0	6
ST92503SC	308.0	10.9	35.0	320.0	6
ST92504SC	454.0	16.0	45.0	320.0	6
ST92505	778.0	27.4	60.0	385.0	4

Soft Face Hammer Tip

- Ideal for various applications and use on a variety of surfaces and materials without marring and surface damage
- Hammer head hardness match material surface hardness can avoid surface abrasion and dents
- It will not be deformed, broken or leave any remnants
- Suitable for installing work without damaging the object surface
- Meets or exceeds ASME B107.410



 This product is consumable, not within SATA Lifetime Warranty.

Article Code	Diameter (mm)	
ST92521SC	22.0	6
ST92522SC	28.0	6
ST92523SC	35.0	6
ST92524SC	45.0	6
ST92525SC	60.0	6

Hard Face Hammer Tip

- Ideal for various applications and use on a variety of surfaces and materials without marring and surface damage
- Hammer head hardness match material surface hardness can avoid surface abrasion and dents
- It will not be deformed, broken or leave any remnants
- Suitable for installing work without damaging the object surface
- Meets or exceeds ASME B107.410



 This product is consumable, not within SATA Lifetime Warranty.

Article Code	Diameter (mm)	
ST92531SC	22.0	6
ST92532SC	28.0	6
ST92533SC	35.0	6
ST92534SC	45.0	6
ST92535SC	60.0	6

Dead Blow Hammer

- Canister filled with steel shot in the hammer's head creates a dead blow effect to reduce rebound
- Non-sparking, non-marring soft face won't harm your target surface
- Resistant to gas, brake fluid, anti-freeze and more, with a polyurethane head and rubber handle
- Rubber handle has a knurled texture and flared back end for improved non-slip grip
- Ideal for professional environments where fire prevention is a priority or concern
- Meets or exceeds ASME B107.410





Article Code	Head Weight (g)	Head Weight (oz)	Head Diameter (mm)	Overall Length (mm)	
ST92901SC	400.0	14.1	35.0	260.0	6
ST92902SC	520.0	18.3	45.0	286.0	6
ST92903SC	1050.0	37.0	55.0	350.0	4
ST92904SC	1500.0	52.9	65.0	370.0	4

Rubber Mallet Hammer

- Ideal for various applications and use on a variety of surfaces and materials without marring and surface damage
- Meets or exceeds ASME B107.410



 Nature of this product is subject to wear and tear upon usage. Not covered under Lifetime Warranty.

Article Code	Head Weight (g)	Head Weight (oz)	Overall Length (mm)	
ST92912ME	454.0	16.0	330.0	6
ST92913ME	567.0	20.0	331.0	6



GEMATA
12811 1.5/16" 0.581111

LOAD 545

PSI

Industrial Work Lights



INDUSTRIAL WIRELESS RECHARGEABLE WORK LIGHT

ST90606
ST90607

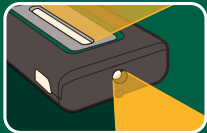

Top light included



360° swivel hook

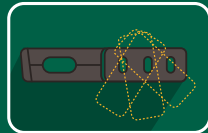

Lamp stand folds and sets to different angles



IP65 dust and water-proof design



Magnet in base and back



Wireless or USB rechargeable



0-6h



LUMENS
300/100



2.5h



0-10h



LUMENS
600/100



2.5h





Industrial Wireless Rechargeable Work Light

- Dual LED 300 (front) and 100 (top) lumen ratings for high intensity illumination
- Wireless or USB rechargeable lithium ion battery
- IP65 dust and water-proof design convenient for outdoor use
- Pocket-sized, lightweight design is easy to carry and store
- Adjustable lamp stand folds and sets to different angles
- Efficient LED strip made with COB technology for a wide range of applications
- Magnet in base and back for easy positioning and hand free use
- 360° swivel hook for easy positioning and hands free use
- Battery level indicated by LED display
- Lithium ion battery provides up to 6 hours of run time



Not covered under Lifetime Warranty.

Industrial Wireless Charger not included.

Article Code	Front Light	Top Light	Charging Time	Operating Time	Input
ST90606	300 lm	100 lm	approx. 2.5 h (cable) / 3.5 h (wireless)	approx. 3 h (front) / 6 h (top)	5 V, 1 A

Power	Battery	Protection Degree	Dimensions (LxWxH)	Net Weight	Content
3 W (front) / 1 W (top)	Li-ion 3.7 V; 1500 mAh	IP65	133 x 68 x 25 mm	200 g	Work Light; Charging Cable USB Type C



Industrial Wireless Rechargeable Work Light

- Dual LED 600 (front) and 100 (top) lumen ratings for high intensity illumination
- Wireless or USB rechargeable lithium ion battery
- IP65 dust and water-proof design convenient for outdoor use
- Impact resistant case is lightweight and durable
- Adjustable lamp stand folds and sets to different angles
- Efficient LED strip made with COB technology for a wide range of applications
- Magnet in base and back for easy positioning and hand free use
- 360° swivel hook for easy positioning and hands free use
- Battery level indicated by LED display
- Lithium ion battery provides up to 10 hours of run time



Not covered under Lifetime Warranty.

Industrial Wireless Charger not included.

Article Code	Front Light	Top Light	Charging Time	Operating Time	Input
ST90607	600 lm	100 lm	approx. 2.5 h (cable) / 4.5 h (wireless)	approx. 3 h (front) / 10 h (top)	5 V, 2 A

Power	Battery	Protection Degree	Dimensions (LxWxH)	Net Weight	Content
6 W (front) / 1 W (top)	Li-ion 3.7 V; 2600 mAh	IP65	205 x 55 x 40 mm	302 g	Work Light; Charging Cable USB Type C

INDUSTRIAL FOLDABLE SLIM WORK LIGHT

ST90608
ST90620



Top light
included



360° swivel hook

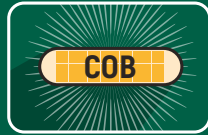

Efficient LED
strip made with
COB technology

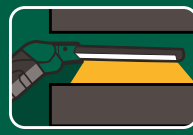

Ultra-thin
aluminum alloy
lamp head

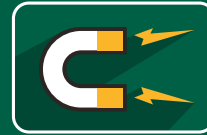

Magnet in
base and back



Lithium ion
battery



Industrial Wireless Rechargeable and Foldable Slim Work Light



- Dual LED 600 (front) and 100 (top) lumen ratings for high intensity illumination
- Wireless or USB rechargeable lithium ion battery
- Ultra-thin aluminum alloy lamp head designed for small spaces
- Light pivots 180° and rotates 270° to direct the beam where you need it
- Lightweight and durable design
- Efficient LED strip made with COB technology for a wide range of applications
- Magnet in base and back for easy positioning and hand free use
- 180° swivel hook for easy positioning and hands free use
- Battery level indicated by LED display
- Lithium ion battery provides up to 10 hours of run time



Industrial Wireless Charger not included.



Not covered under Lifetime Warranty.

Article Code	Front Light	Top Light	Charging Time	Operating Time	Input
ST90608	600 lm	100 lm	approx. 2.5 h (cable) / 4.5 h (wireless)	approx. 3 h (front) / 10 h (top)	5 V, 2 A

Power	Battery	Protection Degree	Dimensions (LxWxH)	Net Weight	Content
6 W (front) / 1 W (top)	Li-ion 3.7 V; 2600 mAh	IP54	325 x 44 x 38 mm	250 g	Work Light; Charging Cable USB Type C

Industrial Foldable Slim Work Light



- Dual LED 400 (front) and 80 (top) lumen ratings for high intensity illumination
- Ultra-thin aluminum alloy lamp head designed for small spaces
- Light pivots 180° and rotates 180° to direct the beam where you need it
- IP20 dust and moisture proof design
- Lightweight and durable design
- Efficient LED strip made with COB technology for a wide range of applications
- Magnet in base and back for easy positioning and hand free use
- 180° swivel hook for easy positioning and hands free use
- Lithium ion battery provides up to 8 hours of run time



Not covered under Lifetime Warranty.

Article Code	Front Light	Top Light	Charging Time	Operating Time	Input
ST90620	400 lm	80 lm	approx. 3 h	approx. 3 h (front) / 8 h (top)	5 V, 1 A

Power	Battery	Protection Degree	Dimensions (LxWxH)	Net Weight	Content
3 W (front) / 1 W (top)	Li-ion 3.7 V; 2000 mAh	IP20	300 x 44 x 34 mm	200 g	Work Light; Charging Cable Micro USB



Industrial Water Proof Flood Light

- 1000 lumen rating for high intensity illumination
- IP65 dust and water-proof design convenient for outdoor use
- ABS plastic shell + TPR front cover to protect from falling and damage
- 270° pivot directs light where you need it
- USB rechargeable lithium ion battery
- Soft shade optical precision reduces glare discomfort without compromising brightness
- Built-in 4000 mAh lithium ion battery
- Two levels of light intensity settings at 50% and 100% brightness
- Battery level indicated by LED display
- Lithium ion battery provides up to 5 hours of run time



 Not covered under Lifetime Warranty.

Article Code	Light	Charging Time	Operating Time	Input
ST90613	1000 lm (100%) / 500 lm (50%)	approx. 4.5 h	approx. 3 h (100%) / 5 h (50%)	2.7 A (max.)

Power	Battery	Protection Degree	Dimensions (LxWxH)	Net Weight	Content
10 W	Li-ion 3.7 V; 4000 mAh	IP65	173 x 133 x 43 mm	400 g	Flood Light; Charging Cable USB Type C



Industrial Water Proof Flood Light

- 2000 lumen rating for high intensity illumination
- IP65 dust and water-proof design convenient for outdoor use
- ABS plastic shell + TPR front cover to protect the product from falling and damage
- 270° pivot directs light where you need it
- USB rechargeable lithium ion battery
- Soft shade optical precision reduces glare discomfort without compromising brightness
- Built-in 8000 mAh lithium ion battery
- Two levels of light intensity settings at 50% and 100% brightness
- Battery level indicated by LED display
- Lithium ion battery provides up to 5 hours of run time



 Not covered under Lifetime Warranty.

Article Code	Light	Charging Time	Operating Time	Input
ST90614	2000 lm (100%) / 1000 lm (50%)	approx. 4.5 h	approx. 3 h (100%) / 5 h (50%)	6.7 A (max.)

Power	Battery	Protection Degree	Dimensions (LxWxH)	Net Weight	Content
20 W	Li-ion 3.7 V; 8000 mAh	IP65	204 x 156 x 51 mm	690 g	Work Light; Charging Cable USB Type C

Industrial Single Output Wireless Charger

- Single output wireless charger
- Easy wireless charging with built-in, safe magnet connection
- Wireless charging function compatible with mobile phones
- USB output
- Suitable for ST90606, ST90607 and ST90608 Industrial Wireless Rechargeable Work Light



 Not covered under Lifetime Warranty.

Article Code	Power	Dimensions (LxWxH)	Net Weight	Input
ST90609	5 W	151x106x18 mm	190 g	5 V, 2 A

Industrial Double Output Wireless Charger

- Double output wireless charger
- Easy wireless charging with built-in, safe magnet connection
- Wireless charging function compatible with mobile phones
- USB output
- Suitable for ST90606, ST90607 and ST90608 Industrial Wireless Rechargeable Work Light



 Not covered under Lifetime Warranty.

Article Code	Power	Dimensions (LxWxH)	Net Weight	Input
ST90610	5 W (single) / 10 W (double)	202x106x18 mm	270 g	5 V, 2 A



Measuring



Tape Measure

- ABS housing for increased strength and impact resistance
- Double-sided scale with measurement markings on the top and bottom side of the scale
- Bright yellow blade has clear easy-to-read numerals
- Nylon-coated blade provides extended product life and glare reduction
- Extra-Wide lock button for easy thumb engagement
- Blade lock holds blade at any length
- Tape measure hook with automatic reset setting, ensuring that both internal and external measurement start from zero position
- Automatic blade return
- Ergonomic case design for better fit in-hand during measuring
- Integrated D-ring with keychain attachment for carrying or storing convenience



 Nature of this product is subject to wear and tear upon usage. Not covered under Lifetime Warranty.

Article Code	Tape Length	Tape Width (mm)	Blade Style	
ST91311E	2.0 m	13.0	Metric	12
ST91312E	3.0 m	16.0	Metric	12
ST91315E	5.0 m	25.0	Metric	6
ST91316E	8.0 m	25.0	Metric	4
ST91317E	10.0 m	25.0	Metric	4
ST91318E	3.0 m / 10'	16.0	Metric / SAE	12
ST91322E	5.0 m / 16'	19.0	Metric / SAE	6
ST91323E	8.0 m / 26'	25.0	Metric / SAE	4

Tape Measure

- ABS housing for increased strength and impact resistance
- Bright yellow blade has clear easy-to-read numerals
- Clear coating extends life of blade and blade markings
- Blade lock holds blade at any length
- Tape measure hook with automatic reset setting, ensuring that both internal and external measurement start from zero position
- Automatic blade return
- Optimized design provides a compact case that fits comfortably in the palm of your hand
- Removable belt clip



 Nature of this product is subject to wear and tear upon usage. Not covered under Lifetime Warranty.

Article Code	Tape Length	Tape Width (mm)	Blade Style	
ST91312ME	3.0 m / 10'	13.0	Metric / SAE	12
ST91314ME	5.0 m / 16'	19.0	Metric / SAE	12
ST91316ME	8.0 m / 26'	25.0	Metric / SAE	12
ST91317ME	10.0 m / 33'	25.0	Metric / SAE	12

TAPE MEASURE METRIC/ SAE SCALE

ST91311E
ST91312E
ST91315E
ST91316E
ST91317E
ST91318E
ST91322E
ST91323E



ABS housing for
resistance

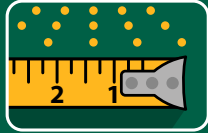

Nylon-coated
blade



Extra-wide lock
button



Lock holds blade
at any length



Hook with auto-
matic reset
setting



Integrated
D-ring with
keychain

METRIC

SAE



Rubber Grip Tape Measure

- Rubber cushion housing absorbs impact for increased strength resistance
- Bright yellow blade has clear easy-to-read numerals
- Clear coating extends life of blade and blade markings
- Blade lock holds blade at any length
- Tape measure hook with automatic reset setting, ensuring that both internal and external measurement start from zero position
- Automatic blade return
- Optimized design provides a compact case that fits comfortably in the palm of your hand
- Rubber cushion for improved grip
- Removable belt clip



 Nature of this product is subject to wear and tear upon usage. Not covered under Lifetime Warranty.

Article Code	Tape Length	Tape Width (mm)	Blade Style	
ST91333ME	3 m / 10'	16.0	Metric / SAE	12
ST91335ME	5 m / 16'	19.0	Metric / SAE	12
ST91336ME	8 m / 26'	25.0	Metric / SAE	12

Fiberglass Long Tape

- Non-conductive, easy-to-read numerals
- High impact winding drum for smooth tape recovery
- UV coating extends life of blade and blade markings



 Nature of this product is subject to wear and tear upon usage. Not covered under Lifetime Warranty.

Article Code	Tape Length	Tape Width (mm)	Blade Style	
ST91361ME	15 m / 49'	13.0	Metric / SAE	6
ST91362ME	30 m / 98'	13.0	Metric / SAE	4
ST91363ME	50 m / 164'	13.0	Metric / SAE	2

Square Zinc Handle

- Zinc handle
- Metric/Imperial scale
- Manufactured from stainless steel for better strength and longer tool life



⚠ Nature of this product is subject to wear and tear upon usage. Not covered under Lifetime Warranty.

Article Code	Size	Style	
ST91410ME	150 mm / 6"	Metric / SAE	6
ST91411ME	200 mm / 8"	Metric / SAE	6
ST91412ME	250 mm / 10"	Metric / SAE	6
ST91413ME	300 mm / 12"	Metric / SAE	6

LD Square

- Metric/Imperial scale
- Manufactured from stainless steel for better strength and longer tool life



⚠ Nature of this product is subject to wear and tear upon usage. Not covered under Lifetime Warranty.

Article Code	Size	
ST91421ME	610 mm / 24" x 305 mm / 12"	6

3 Pc. Chalk Line Set

Article Code	Content	
ST91430ME	1- 30 m Chalk Reel 1- 115 g Blue Chalk 1- Plastic Line Level	10

⚠ Nature of this product is subject to wear and tear upon usage. Not covered under Lifetime Warranty.

Article Code	Content	
ST91431ME	Chalk Refill Blue 115g	20
ST91432ME	Chalk Refill Red 115g	20



3 PC. CHALK LINE SET

ST91430ME



Impact
resistant case



Folding crank
handle



Locking button



Rubber grip



Vernier Caliper

- Manufactured from stainless steel for high measurement accuracy
- For measurement of inner hole, outer circle, and depth
- Comes in a high quality ABS plastic box



 Nature of this product is subject to wear and tear upon usage. Not covered under Lifetime Warranty.



Article Code	Size	Accuracy	
ST91501SC	0.0 - 150 mm	±0.03 mm	6
ST91502SC	0.0 - 200 mm	±0.03 mm	6
ST91503SC	0.0 - 300 mm	±0.03 mm	4

Digital Caliper

- Easy to read large digital display
- 4 way measurement, inside, outside, depth and step ensures accuracy
- Scale and thumb roll makes reset possible at any position
- Wide and clear display measurements in either metric or Imperial units
- Features standard RS-232 output port for easy data collection
- Manufactured from stainless steel for better strength and longer tool life
- Comes in a high quality ABS plastic box



 Nature of this product is subject to wear and tear upon usage. Not covered under Lifetime Warranty.

Article Code	Size	Accuracy	
ST91511SC	0 - 150 mm	±0.03 mm	6
ST91512SC	0 - 200 mm	±0.03 mm	6
 ST91513	0 - 300 mm	±0.03 mm	6

Dial Caliper

- Manufactured from stainless steel for high measurement accuracy
- Upgraded indicator core for two-way shockproof performance
- Equipped with outer ring locking device
- For measurement of inner hole, outer circle, and depth
- Comes in a high quality ABS plastic box



 Nature of this product is subject to wear and tear upon usage. Not covered under Lifetime Warranty.

Article Code	Size	Accuracy	
ST91521SC	0 - 150 mm	±0.03 mm	6
ST91522SC	0 - 200 mm	±0.03 mm	6

Outside Micrometer

- Measuring surface made from hardened steel to withstand repeated use
- Clearly audible ratchet operation for reassurance that measurement is being performed at constant force
- Locking screw and precision mechanism combine for exceedingly accurate measurements
- Comes in a high quality ABS plastic box



 Nature of this product is subject to wear and tear upon usage. Not covered under Lifetime Warranty.

Article Code	Size	Accuracy	
ST91531SC	0 - 25 mm	±0.004 mm	6
ST91532SC	25 - 50 mm	±0.004 mm	6
ST91533SC	50 - 75 mm	±0.004 mm	6

Aluminum Box Level

- Best frame strength-to-weight ratio
- Helps with fast and accurate installations
- Ruler with scale for easy measurement
- Built from one piece of aluminum for strength and durability
- Two shock absorbent end caps protect frame



 Nature of this product is subject to wear and tear upon usage. Not covered under Lifetime Warranty.



Article Code	Size	Accuracy	
ST91601ME	30 cm	±0.5 mm/m	10
ST91602ME	45 cm	±0.5 mm/m	10
ST91603ME	60 cm	±0.5 mm/m	10
ST91604ME	75 cm	±0.5 mm/m	6
ST91605ME	90 cm	±0.5 mm/m	6
ST91606ME	120 cm	±0.5 mm/m	6

Aluminium Magnetic Box Level

- Magnetic, easy to operate
- Best frame strength-to-weight ratio
- Helps with fast and accurate installations
- Ruler with scale for easy measurement
- Built from one piece of aluminum for strength and durability
- Two shock absorbent end caps protect frame



 Nature of this product is subject to wear and tear upon usage. Not covered under Lifetime Warranty.

Article Code	Size	Accuracy	
ST91611ME	30.0 cm	±0.5 mm/m	10
ST91612ME	45.0 cm	±0.5 mm/m	10
ST91613ME	60.0 cm	±0.5 mm/m	10
ST91614ME	75.0 cm	±0.5 mm/m	10
ST91615ME	90.0 cm	±0.5 mm/m	6
 ST91616	120.0 cm	±0.5 mm/m	5

Magnetic Torpedo Level

- Magnetic, easy to operate
- Helps with fast and accurate installations
- Two shock absorbent end caps protect frame





 Nature of this product is subject to wear and tear upon usage. Not covered under Lifetime Warranty.

Article Code	Size	Accuracy	
ST91621ME	230 mm / 9"	±0.5 mm/m	10

Steel Rule

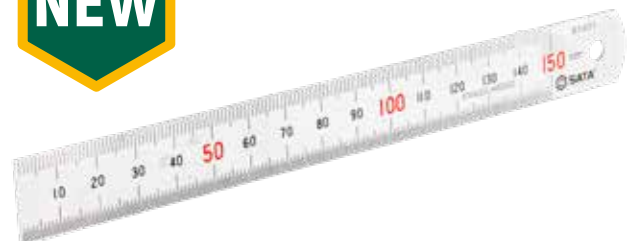
- Manufactured from stainless steel for improved strength and durability
- Easy-to-read graduations marked on both sides on both edges
- Deeply-etched permanent markings are black- and red-filled for easy reading and wear resistance



 Nature of this product is subject to wear and tear upon usage. Not covered under Lifetime Warranty.

Article Code	Size	Total Length (mm)	
ST91401	6"	150.0	12
ST91402	12"	300.0	9
ST91403	20"	500.0	9
ST91404	40"	1000.0	4

PROFESSIONAL LASER DISTANCE METER

ST62712
ST62713



Measurement accuracy
 $\pm 0.08''$
 $\pm 2\text{mm}$



Angle measurement function



Beeper prompts measurement recording



5 lines of data shown simultaneously



Stores up to 20 sets of data history

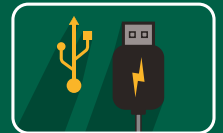

Easily rechargeable with micro USB

60m

100m

SAE

METRIC



Laser Distance Meter

- Measurement accuracy of +/-3mm
- Compact size for convenient transportation and storage
- Single key for easy operation
- HD backlight display shows data clearly
- Rugged case for durability
- Automatic shutdown for saving power

✓ Single measurement



Nature of this product is subject to wear and tear upon usage. Not covered under Lifetime Warranty.

Article Code	Range	Measuring Unit	Laser Level	Laser Type	Battery	
ST62709	30 m	m / ft + in	Class 2	630 - 670 nm, < 1 mW	AAA 2x1.5V	6

Professional Laser Distance Meter

- Measurement accuracy +/-2mm
- Angle measurement function
- Display capable of showing 5 lines of data simultaneously for comparison
- Stores up to 20 sets of data history
- Beeper prompts when measurement has been recorded
- Easily rechargeable with common micro USB
- Automatic shutdown for saving power

- ✓ Single measurement
- ✓ Continuous measurement
- ✓ Area measurement
- ✓ Volume measurement
- ✓ Simple Pythagorean
- ✓ Quadratic Pythagorean
- ✓ Automatic level
- ✓ Automatic vertically
- ✓ Addition and Subtraction
- ✓ Angular Transducer



Nature of this product is subject to wear and tear upon usage. Not covered under Lifetime Warranty.

Article Code	Range	Measuring Unit	Laser Level	Laser Type	
ST62712	60 m	m /ft/ in /ft+in	Class 2	630 - 670 nm, < 1 mW	1
ST62713	100 m	m /ft/ in /ft+in	Class 2	630 - 670 nm, < 1 mW	1



SATA 91318E
8m

Auto Speciality Tools



3 Pc. L-Shaped Wheel Wrench Set

Article Code	Content	
ST09531SJ	1- 1/2" Dr. Offset Handle 345 mm 1- 1/2" Dr. Dual Head Socket 17x19 mm 1- 1/2" Dr. Dual Head Socket 21x23 mm	5

 Please refer to the warranty terms of the individual product.



6 Pc. Automotive Body Repair Tool Set

Article Code	Content	
ST09152SJ	1- Anvil Dolly 1- Wedge Dolly 1- Pry Bumping Spoon 1- Toe Dolly 1- Light Shrinking Hammer 1- Pick & Finishing Hammer	2

 Please refer to the warranty terms of the individual product.



50 Pc. Auto Repair Master Tool Set

Article Code	Content	
ST09508	1- 1/2" Dr. Quick-Release Ratchet 11- 1/2" Dr. 12pt. Metric Sockets 8, 10, 12, 17, 18, 19, 20, 21, 22, 24, 27 mm 1- 1/2" Dr. 50L Bit Socket Hex 17 mm 1- 1/2" Dr. 100L Bit Socket Hex 7 mm 9- 1/2" Dr. Extra Long Bit Sockets Hex 6x70, 8x120, 6x250, 5x180, 6x140, 10x140 mm Triple Square M8x100, M10x120, M10x140 mm 9- Extra Long Arm Ball Point Hex Key Set 1.5, 2, 2.5, 3, 4, 5, 6, 8, 10 mm 2- 1/2" Dr. Spark Plug Sockets 16, 21 mm 6- Raised Panel Combination Wrenches 8, 10, 13, 17, 19, 22 mm 2- Cushion Grip Go-Through Screwdrivers Slotted 6x100 mm Phillips #6x100 mm 8- Accessories 1/2" Dr. T-Handle 1/2" Dr. Wobble Extension Bars 5", 10" 1/2" Dr. Universal Joint 1/2" Dr. Offset Handle 260 mm 3/8" Dr. Two Way Oil Filter Wrench with Adapter Front Shock Absorber Socket Wrench Shock Absorber Socket	2

 Please refer to the warranty terms of the individual product.



56 Pc. Auto Repair Master Tool Set

Article Code	Content	
ST09509	1 - 3/8" Dr. Quick-Release Ratchet 15 - 3/8" Dr. 6pt. Metric Sockets 7, 8, 10, 11, 12, 13, 14, 15, 16, 17, 18, 19, 21, 22, 24 mm 2 - 3/8" Dr. Spark Plug Sockets 16, 21 mm 11 - Metric Combination Wrenches 8, 10, 12, 13, 14, 15, 16, 17, 18, 19, 22 mm 1 - Long Nose Pliers 6" 1 - Slip Joint Pliers 2 - Cushion Grip Go-Through Screwdrivers Slotted 6x100 mm Phillips #2x100 mm 9 - 1/4" Shank 25L Bits Slotted 4, 5, 6, 5 mm Phillips #1, #3 Hex 3, 4, 5, 6 mm 9 - Accessories 1/4" Dr. Spinner Handle 1/4" Dr. x1/4" Shank Bit Adapter 3/8" Dr. Wobble Extension Bars 3", 10" 3/8" Dr. Universal Joint 1/4" Fx3/8" M, 3/8"Fx1/4" M Socket Adapters 1/2" Fx3/8" M 3-Way Adapter 9 Pc. Long Arm Tamper-Proof Torx® Key Set TT10, TT15, TT20, TT25, TT27, TT30, TT40, TT45, TT50	3



 Please refer to the warranty terms of the individual product.

53 Pc. Telecom Set

Article Code	Content	
ST09535SJ	11 - 1/4" Dr. 6pt. Metric Sockets 4, 5, 5.5, 6, 7, 8, 9, 10, 11, 12, 13 mm 15 - 1/4" Shank 25L Bits Slotted 4, 5.5, 6.5 mm Phillips #1, #2, #3 Tamper-Proof Torx® T10, T15, T20 Hex 2, 2.5, 3, 4, 5, 6 mm 4 - Acetate Screwdrivers Phillips #1x75 mm, #2x200 mm Slotted 5x75 mm, 6x100 mm 6 - Precision Combination Screwdrivers Phillips #000x75 mm, #0x100 mm, #1x150 mm Slotted 2x75 mm, 3x100 mm, 4x150 mm 17 - Accessories 1/4" Drive Bit Adapter 25 mm 1/4" Drive Magnetic Bit Driver Circuit Tester Long Nose Pliers 6" Diagonal Pliers 6" Electrician's Knife Soldering Iron 30W Soldering Iron Stand Anti-static Brush Digital Multi-meter Desoldering Pump Insulation Tape Adjustable Wrench 6" Solder Wire 17G Aluminum Flashlight Self Adjusting Wire Stripper 6-1/2" Tape Measure 3 m"	2



 Please refer to the warranty terms of the individual product.

HYDRAULIC BOTTLE JACK

ST97801ASC
ST97802ASC
ST97803ASC
ST97804ASC
ST97805ASC
ST97807ASC
ST97808ASC
ST97809ASC
ST97810ASC



Welded steel
construction

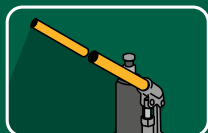

Two-Piece
handle design



Center
adjustment



Double levers
for user
ergonomics



HEAVY DUTY LOW PROFILE SERVICE JACK 2T / 3T

ST97817SC
ST97813A



Safety overload device



Dual piston pump

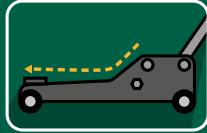

Ultra low profile

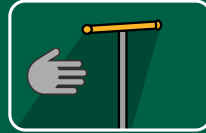

Dual handle design

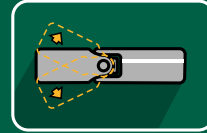

Precision control in any handle position



Ergonomic design



Hydraulic Bottle Jack

- Welded steel construction for leak free performance
- Two-piece handle design for easy storage
- Center Adjustment
- Double levers for user ergonomics



Nature of this product is subject to wear and tear upon usage. Not covered under Lifetime Warranty.

Article Code	Load Capacity	Min. Height (mm)	Max. Height (mm)	Extender Heigt (mm)	
ST97801ASC	2 T	181	344.0	48.0	6
ST97802ASC	4 T	193	373.0	60.0	6
ST97803ASC	6 T	210	416.0	70.0	4
ST97804ASC	8 T	225	455.0	80.0	4
ST97805ASC	10 T	230	460.0	80.0	4
ST97807ASC	16 T	230	440.0	60.0	4
ST97808ASC	20 T	242	452.0	60.0	4
ST97809ASC	32 T	275	440.0	-	4
ST97810ASC	50 T	265	425.0	-	4

Heavy Duty Low Profile Service Jack 2 T

- Built-in safety overload device prevents use beyond rated capacity
- Dual piston pump for rapid lifting
- Ultra low profile is ideal for sport cars and vehicles with flat tires and low chassis
- Patent dual handle design for better leverage and a solid grip
- Universal joint release mechanism for precision control in any handle position
- Ergonomic design
- Manufactured from steel with reinforced body
- Meets or exceeds ASME PALD-2009



Nature of this product is subject to wear and tear upon usage. Not covered under Lifetime Warranty.

Article Code	Load Capacity	Max. Height (mm)	Min. Height (mm)	
ST97817SC	2 T	505.0	76.0	1

Heavy Duty Low Profile Service Jack 3 T

- Built-in safety overload device prevents use beyond rated capacity
- Dual piston pump for rapid lifting
- Ultra low profile is ideal for sport cars and vehicles with flat tires and low chassis
- Patent dual handle design for better leverage and a solid grip
- Universal joint release mechanism for precision control in any handle position
- Manufactured from steel with reinforced body
- Meets or exceeds ASME PALD-2009



Nature of this product is subject to wear and tear upon usage. Not covered under Lifetime Warranty.

Article Code	Load Capacity	Max. Height (mm)	Min. Height (mm)	
ST97813A	3 T	502.0	78.0	1

14 Pc. Feeler Gauge Set 0.05 - 1.00 mm

16 Pc. Feeler Gauge Set 0.05 - 1.00 mm

Article Code	Content	
ST09401SJ	0.05, 0.10, 0.15, 0.20, 0.25, 0.30, 0.40, 0.50, 0.60, 0.70, 0.80, 0.90, 1.00 mm	24

Article Code	Content	
ST09402SJ	0.05, 0.10, 0.15, 0.20, 0.25, 0.30, 0.35, 0.40, 0.50, 0.55, 0.60, 0.70, 0.75, 0.80, 0.90, 1.00 mm	12

Nature of this product is subject to wear and tear upon usage. Not covered under Lifetime Warranty.

Nature of this product is subject to wear and tear upon usage. Not covered under Lifetime Warranty.



23 Pc. Feeler Gauge Set 0.02 - 1.00 mm

Article Code	Content	
ST09405SJ	0.02, 0.03, 0.04, 0.05, 0.10, 0.15, 0.20, 0.25, 0.30, 0.35, 0.40, 0.45, 0.50, 0.55, 0.60, 0.65, 0.70, 0.75, 0.80, 0.85, 0.90, 0.95, 1.00 mm	36

 Nature of this product is subject to wear and tear upon usage. Not covered under Lifetime Warranty.



32 Pc. Feeler Gauge Set 0.02 - 1.00 mm

Article Code	Content	
ST09407SJ	0.02, 0.03, 0.04, 0.05, 0.06, 0.07, 0.08, 0.09, 0.10, 0.13, 0.15, 0.18, 0.20, 0.23, 0.25, 0.28, 0.30, 0.33, 0.38, 0.40, 0.45, 0.50, 0.55, 0.60, 0.63, 0.65, 0.70, 0.75, 0.80, 0.85, 0.90, 1.00 mm	24

 Nature of this product is subject to wear and tear upon usage. Not covered under Lifetime Warranty.



3 Pc. Fuel and AC Disconnect Tool Set

Article Code	Content	
ST09406SJ	1 - Ford fuel line coupling tool 1 - Ford A/C and fuel line spring lock coupling tool 1 - Fuel line quick disconnect tool	10



8 Pc. End Cap Oil Filter Wrench Set

Article Code	Content	
ST09703SJ	6 - 1/2" Dr. End Cap Oil Filter Wrenches 65, 74, 76, 80, 90, 93 mm 1 - 3/8" Dr. Quick-Release Ratchet 1 - 3/8" Fx1/2" M Socket Adapter	4



End Cap Oil Filter Wrench

- For use with a 1/2" square drive tool
- Black electro-deposition coated finish for durability and corrosion resistance
- Overtop access application



Article Code	Size (mm)	Flute (mm)	
ST97401ST	65.0	14.0	4
ST97403ST	74.0	15.0	4
ST97404ST	76.0	14.0	4
ST97405	80.0	15.0	4
ST97406	90.0	15.0	4

Drive End Cap Oil Filter Wrench

- For use with a 1/2" square drive tool
- Black electro-deposition coated finish for durability and corrosion resistance
- Overtop access application





Article Code	Size (mm)	Flute (mm)	
ST97407	93.0	15.0	4

Oil Filter Wrench

- Universal adjustment
- Professional, ergonomic dipped grips wipe clean easily
- Chrome plated finish to resist corrosion



 Nature of this product is subject to wear and tear upon usage. Not covered under Lifetime Warranty.

Article Code	Size (mm)	
ST97427SC	55.0 - 75.0	12
ST97428SC	75.0 - 95.0	12

Oil Filter Strap Wrench

- Strap is made of high strength nylon and handle is made of forged steel
- Use with 1/2" drive tools or 13/16" wrench tools to handle filters with diameters up to 120 mm



 Nature of this product is subject to wear and tear upon usage. Not covered under Lifetime Warranty.

Article Code	Size (mm)	Capacity (mm)	
ST97431ME	240.0	120.0	12

Oil Filter Strap Wrench

- For use on oil filters up to 120 mm diameter
- Strong nylon belt will not slip
- Use with 1/2" drive tools or 13/16" wrench tools
- Chrome vanadium steel buckle



Article Code	Size	Capacity (mm)	
ST97441ST	18"	120.0	12

Universal 3-Jaw Oil Filter Wrench

- Use with 1/2" square drive tools with no adapter required
- Heavy duty design with increased torque to loosen tough filters
- Provides a wide application range from 63 - 102 mm (2.5" - 4")



Article Code	Max Diameter (mm)	Min Diameter (mm)	
ST97422ST	102.0	63.0	2

Adjustable Oil Filter Wrench Pliers

- Two clamp handle for maximum clamping power
- Professional dipped grips for easy cleaning and better control
- For removing oil filters from 63.5 mm to 116.0 mm in diameter



Article Code	Max Diameter (mm)	Min Diameter (mm)	
ST97426ST	116.0	63.5	6

Chain Wrench

- Excellent for pipe fittings
- Great for confined areas where regular pipe wrenches cannot reach
- High-visibility stamped markings provide quick size identification
- Bright, full polish chrome finish easily wipes clean and resists corrosion
- Manufactured from steel for better strength and longer tool life



Article Code	Size	Capacity (mm)	
ST97451SC	12"	55.0 - 110.0	4
ST97452SC	15"	60.0 - 130.0	4

1/2" Drive Air Impact Wrench 625 Nm



- Hard hitting twin hammer provides high torque output while reducing vibration
- Handle exhaust at bottom cable directs debris and dust away from machine and operator
- Variable speed trigger gives control over RPM
- Compact design
- 1/4" Air intake



Nature of this product is subject to wear and tear upon usage. Not covered under Lifetime Warranty.

Article Code	Max Torque	Working Torque	Free Rotation	Working Pressure	Air Consumption	Weight	
ST01111	625 Nm	400 Nm	10.000 RPM	90 PSI, 6,35 kgf/cm ²	4.7 CFM	1.5 kg	10

1/2" Drive Air Impact Wrench 800 Nm



- Hard hitting twin hammer provides high torque output while reducing vibration
- Handle exhaust at bottom cable directs debris and dust away from machine and operator
- Variable speed trigger gives control over RPM
- Classic design
- 1/4" Air intake



Nature of this product is subject to wear and tear upon usage. Not covered under Lifetime Warranty.

Article Code	Max Torque	Working Torque	Free Rotation	Working Pressure	Air Consumption	Weight	
ST01113C	800 Nm	600 Nm	7.500 RPM	90 PSI, 6,35 kgf/cm ²	4.2 CFM	2.2 kg	6

1/2" Drive Air Impact Wrench 1050 Nm



- Hard hitting twin hammer provides high torque output while reducing vibration
- Handle exhaust at bottom cable directs debris and dust away from machine and operator
- Variable speed trigger gives control over RPM
- Solid fiberglass handle covered with a molded nylon jacket
- 1/4" Air intake



Nature of this product is subject to wear and tear upon usage. Not covered under Lifetime Warranty.

Article Code	Max Torque	Working Torque	Free Rotation	Working Pressure	Air Consumption	Weight	
ST01119	1050 Nm	800 Nm	8.500 RPM	90 PSI, 6,35 kgf/cm ²	4.8 CFM	2.2 kg	6

1" Drive Heavy Duty Air Impact Wrench



- Shock resistant housing with plastic protector helps protect tool and prevent scuffing
- Ergonomic design is 10% lighter than competitors without compromising on performance
- 9" (23 cm) rod can be used for automotive repairs, major construction projects, heavy equipment maintenance, or product assembly
- Air line does not need to be removed for lubrication
- 45° Air intake for better equipment handling
- 1/2" Air intake



Nature of this product is subject to wear and tear upon usage. Not covered under Lifetime Warranty.

Article Code	Max Torque	Working Torque	Idle Speed	Working Pressure	Air Consumption	Weight	
ST01133SC	4000 Nm	3000 Nm	8.500 RPM	110 PSI, 8 kgf/cm ²	15 CFM	16.8 kg	1

1/2" DRIVE AIR IMPACT WRENCH

ST01111
ST01113C
ST01119

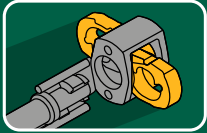

Twin hammer system



Exhaust parallel to cable



Variable speed trigger

1/2"



1" DRIVE HEAVY DUTY AIR IMPACT WRENCH

ST01133SC



Shock resistant
housing



10% lighter

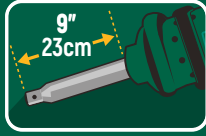

9" (23 cm) rod



No need to re-
move air line
for lubrication



45° Air intake

1"



Piston Ring Compressor

- Tool is beaded along lower edge to prevent compressor from entering the cylinder
- Heavy spring steel compresses the stiffest rings evenly
- Positive lock action provides positive compression and fingertip release



 Nature of this product is subject to wear and tear upon usage. Not covered under Lifetime Warranty.

Article Code	Size	Working Range (mm)	
ST97501SC	3"	53.0 - 175.0	30
ST97502SC	4"	60.0 - 175.0	30

Cross Wheel Wrench

- For use on lugnut sizes 17 mm, 19 mm, 21 mm
- Single hex (6 pt.) fastener end design
- Off-corner loading design reduces fastener rounding
- 1/2" drive end allows for 1/2" drive socket to be added
- Ball detent for secure socket retention
- Bright, full polish chrome finish easily wipes clean and resists corrosion
- Chrome vanadium alloy steel (Cr-V) for exceptional strength and durability



 Nature of this product is subject to wear and tear upon usage. Not covered under Lifetime Warranty.

Article Code	Size	
ST48101ST	17, 19, 21 mm, 1/2"	4

5 Pc. Fine Threaded Extractor Set

- Fine thread for removing screws and studs that cannot be held firmly
- Tapered extractors for broken screws and studs
- Coarse thread design for longer usage life
- Tempered steel construction offers strength and durability for long-lasting performance
- Comes in sturdy plastic case for organization and storage



 Nature of this product is subject to wear and tear upon usage. Not covered under Lifetime Warranty.

Article Code	Content	
ST09704SJ	2, 3, 4, 6.5, 7 mm	20

5 Pc. Coarse Threaded Extractor Set

- Used to quickly remove broken, embedded or damaged screws
- Coarse thread design for longer usage life
- Tempered steel construction offers strength and durability for long-lasting performance
- Comes in sturdy plastic case for organization and storage



 Nature of this product is subject to wear and tear upon usage. Not covered under Lifetime Warranty.

Article Code	Content	
ST09704ASJ	3.3, 5.3, 6.4, 8.8, 11.2 mm	6

5 Pc. Hook and Pick Set

- Use to pull O-rings, seals, and split pins quickly and easily
- Includes magnetic handle
- Magnetic handle retrieves small ferrous metal parts easily
- Heat treated for long lasting durability



 Nature of this product is subject to wear and tear upon usage. Not covered under Lifetime Warranty.

Article Code	Content	
ST09709SJ	1 - Magnetic Aluminum Handle 5" 4 - Picks O-Ring, 90°, Straight, Hook	20

2-Jaw Reversible Pullers

- Reversible Jaws for internal or external applications
- Heat treated for long lasting durability
- Pilot point on screw tip for centering
- Phosphate coating on the spindle to resist corrosion
- Chrome vanadium alloy steel (Cr-V) for exceptional strength and durability



Article Code	Size	Overall Length (mm)	Jaw Capacity (mm)	
ST90623SC	3"	125.0	75.0	1
ST90624SC	4"	155.0	100.0	1
ST90626SC	6"	240.0	150.0	1
ST90628SC	8"	325.0	200.0	1

3-Jaw Reversible Pullers

- Reversible Jaws for internal or external applications
- Heat treated for long lasting durability
- Pilot point on screw tip for centering
- Phosphate coating on the spindle to resist corrosion
- Chrome vanadium alloy steel (Cr-V) for exceptional strength and durability



Article Code	Size	Overall Length (mm)	Jaw Capacity (mm)	
ST90633SC	3"	125.0	75.0	1
ST90634SC	4"	155.0	100.0	1
ST90636SC	6"	240.0	150.0	1
ST90638SC	8"	325.0	200.0	1
ST90640	10"	340.0	250.0	1
ST90642	12"	385.0	300.0	1

Ball Joint Puller Large

- 2 Jaw puller design
- Swivel design provides better access to hard to reach areas
- Jaws spread up to 10-150 mm (0.39" - 5.91") wide
- Chrome plated finish to resist corrosion
- Chrome vanadium alloy steel (Cr-V) for exceptional strength and durability



Article Code	Jaw Capacity	
ST90662SC	10.0-150.0 mm (0.39"-5.91")	6

Universal Ball Joint Separator

- Tool separates ball joints from steering knuckles
- Adjustable for removing ball joints in limited space
- Heat treated for long lasting durability
- Chrome vanadium alloy steel (Cr-V) for exceptional strength and durability



Article Code	
ST90651SC	6

50 - 75 mm Bearing Separator

- For pulling and removing bearings
- Chrome molybdenum alloy steel (Cr-Mo) for exceptional strength and durability



 Nature of this product is subject to wear and tear upon usage. Not covered under Lifetime Warranty.

Article Code	
ST90658ST	12

Ball Joint Separator

- Tool separates ball joints from steering knuckles
- Forged to withstand hard usage



Article Code	Size	
ST90665	12"	6

Universal Ball Joint Separator

- Tool separates ball joints from steering knuckles
- Works on ball joints from 1-1/8" - 2-1/8" and 30 mm - 56 mm in size
- Adjustable for removing ball joints in limited space
- Heat treated for long lasting durability
- Chrome vanadium alloy steel (Cr-V) for exceptional strength and durability



Article Code	Capacity	
ST90652SC	3.0 - 56.0 mm (1-1/8 - 2-1/8")	16

Wheel Weight Tool

- Designed to install and remove all types of wheel weight



 Nature of this product is subject to wear and tear upon usage. Not covered under Lifetime Warranty.

Article Code	
ST92107SC	6

Anvil Dolly

- Made of high carbon steel, forged and tempered, for strength and durability



Article Code	
ST92203SC	6

Wedge Dolly

- Made of high carbon steel, forged and tempered, for strength and durability



Article Code	
ST92205SC	6

Toe Dolly

- Made of high carbon steel, forged and tempered, for strength and durability



Article Code	
ST92207SC	6

Drip Molding Spoon

- Made of high carbon steel, forged and tempered, for strength and durability



Article Code	
ST92209SC	6

Coil Spring Compressor

- Reinforced screw thread design to ensure safety
- Suitable for use where space under wheel arch is limited
- Works with 1/2" drive tools or with 21 mm socket and wrench
- Forged steel jaws for extended tool life



Article Code	Size (mm)	
ST97701SC	270.0	8
ST97702SC	370.0	8

Grease Gun Coupler

- Unique coupler design includes a steel ball to prevent backflow of passing lubricants
- Replacement for common grease guns



 Nature of this product is subject to wear and tear upon usage. Not covered under Lifetime Warranty.

Article Code	
ST97211	18

Flexible Grease Gun Whip Hose

- For use with manual grease guns to reach into confined areas
- Heavy duty high strength nylon sleeve for handling high pressure from hand held grease guns



 Nature of this product is subject to wear and tear upon usage. Not covered under Lifetime Warranty.

Article Code	Overall Length (mm)	
ST97212	300.0 mm	9
ST97213	450.0 mm	9

Pistol Grip Grease Gun

- Tips are designed to ensure tighter tolerance and fit
- Hardened spring for constant pressure
- Dual direction loading
- Compact and lightweight construction reduces user fatigue
- Unique filling nipple design with steel ball to prevent backflow
- Special plunger lock for safe and convenient filling



 Nature of this product is subject to wear and tear upon usage. Not covered under Lifetime Warranty.

Article Code	Bulk Capacity	Working Pressure	Max. Working Pressure	Output	
ST97201	100 cc	2900 psi	4000 psi	0.5 oz / 40 strokes	12

Plastic Handle Grease Gun

- 3 Way loading - 400 ml / 14 oz simple package oil, sealed oil tank or 400 CC bulk oil
- Durable die-cast head for longer service life
- Hardened spring for constant pressure
- Unique filling nipple design with steel ball to prevent backflow
- Special plunger lock for safe and convenient filling
- Quality steel lever handle with comfortable rubber grip



 Nature of this product is subject to wear and tear upon usage. Not covered under Lifetime Warranty.

Article Code	Bulk Capacity	Working Pressure	Max. Working Pressure	Output	
ST97203	400 cc	4500 psi	10000 psi	1 oz / 40 strokes	12

Heavy Duty Grease Gun

- 3 Way loading - 400 ml / 14 oz cartridge, filter pump or 600 CC bulk oil
- New "monticle" exhaust nozzle design, improving exhaust effect and lowering air pressure
- Anti-impurity filter screen to prevent blockage caused by impurities entering the grease delivery pipe when adding bulk grease
- Lightweight aluminum alloy nozzle with extended handle design for improved leverage
- Equipped with a hose and nozzle for special access
- Quality steel lever handle with comfortable rubber grip



 Nature of this product is subject to wear and tear upon usage. Not covered under Lifetime Warranty.

Article Code	Bulk Capacity	Working Pressure	Max. Working Pressure	Output	
ST97204A	600 cc	7000 psi	10000 psi	1 oz / 40 strokes	1

High Leverage Riveter

- High leverage design
- Spring loaded
- Convenient nose piece storage in handle
- Designed for 2.4 mm (3/32), 3.2 mm (1/8), 4 mm (5/32), 4.8 mm (3/16) rivets



 Nature of this product is subject to wear and tear upon usage. Not covered under Lifetime Warranty.

Article Code	Size	Included tip sizes	
ST90501SC	8"	2.4, 3.2, 4.0, 4.8 mm	6

High Leverage Riveter With Collection Bottle

- High leverage non-slip handle design provides the power to pull larger rivets and ensures durability
- Pull and set rivets up to 4.8 mm (ST90504) / 6.4 mm (ST90502) with ease
- Plastic collection bottle for easy disposal of spent mandrels
- Heavy duty steel construction



 Nature of this product is subject to wear and tear upon usage. Not covered under Lifetime Warranty.

Article Code	Size	Included tip sizes	
ST90504	11"	2.4, 3.2, 4.0, 4.8 mm	8
ST90502	13"	2.4, 3.2, 4.0, 4.8, 6.4 mm	8

Air Blow Gun

- Working pressure: 5.0 ~ 8.0 kgf/cm²
- Brass pipe fitting size: 1/4" NPT
- Air pipe (I.D. 1/4"): 350 L/min
Air pipe (I.D. 3/8"): 430 L/min
- Air flow:
1/4" inside diameter air tube: 350 L/Min
3/8" inside diameter air tube: 430 L/Min



 Nature of this product is subject to wear and tear upon usage. Not covered under Lifetime Warranty.

Article Code	Size (mm)	
ST97221SC	100.0	5
ST97222SC	250.0	5

Roller Seat with Magnetic Trays

- Air shock adjustable seat to suit any need
- 5 magnetic parts trays in the base for convenient storage
- Solid solvent resistant rubber seat
- Seat swivels 360° for extra mobility
- Simple and fast assembly without any tools required



 Nature of this product is subject to wear and tear upon usage. Not covered under Lifetime Warranty.

Article Code	Width (mm)	Depth (mm)	Hight (mm)	
ST95440	430.0	430.0	550.0	1

40" Creeper with Magnetic Trays

- Metal plates next to headrest for easy mounting of magnetic lights
- 135 kg /300 lb capacity
- Magnetic parts trays for convenient storage
- Custom-molded composite frame provides lasting durability
- Concave design ensures high comfort and ergonomic handling
- Back pad and head rest made of durable reinforced fibre
- Ball bearing casters reduce vibration



 Nature of this product is subject to wear and tear upon usage. Not covered under Lifetime Warranty.

Article Code	Width (mm)	Depth (mm)	Hight (mm)	
ST95441	520.0	1000.0	150.0	1

Circuit Tester

- Measuring range from 100 - 500 V
- Tempered steel construction offers strength and durability for long-lasting performance



 Excluded from Lifetime Warranty terms

Article Code	Size (mm)	
ST62501ST	145.0	24
ST62502ST	190.0	24

Digital Circuit Tester

- LED Digital display
- Testing range of 12, 36, 55, 110 and 220 V
- Features compact design
- No battery required



 Excluded from Lifetime Warranty terms

Article Code	Size (mm)	
ST62601ST	130.0	24

Automotive Circuit Tester 6 V / 12 V / 24 V

- Designed for vehicles low voltage circuits
- Light turns on when voltage is detected
- Flexible coil cord
- Long-life LED tube
- Spring loaded terminal clamp



 Excluded from Lifetime Warranty terms

Article Code	
ST62503ST	10



Other Tools



33" Extendable Indexing Pry Bar

- Head rotates 180° through 14 locking positions for better access and leverage
- Flex head tool provides access to areas fixed head tools cannot reach
- Grooved head profile grips and holds securely, even in tight confines and at the fullest extension
- Black oxide finish to resist corrosion
- Manufactured from steel for better strength and longer tool life
- Meets or exceeds DIN/ASME and ANSI requirements for proven strength, making it the perfect tool for heavy-duty automotive or industrial work



Article Code	Length (mm)	Width (mm)	Hight (mm)	
ST92568	629.0	25.0	25.0	1

2 Pc. Indexing Pry Bar Set

- Heads rotate 180° through 14 locking positions for better access and leverage
- Flex head tools provide access to areas fixed head tools cannot reach
- Grooved head profile grips and holds securely, even in tight confines and at the fullest extension
- Black oxide finish to resist corrosion
- Manufactured from steel for better strength and longer tool life
- Alloy steel bodies and black phosphate finish



Article Code	Content	
ST92569	8, 16"	1

Wood Handle Putty Scraper

- Precision ground blade for heavy duty edges
- Wood handle offers ease of grip so you can work confidently over time
- Can be used for clearing dirt on engine cylinder surface and other metal surfaces



 Nature of this product is subject to wear and tear upon usage. Not covered under Lifetime Warranty.

Article Code	
ST95201ST	12

INDEXING PRY BARS

ST92568
ST92569

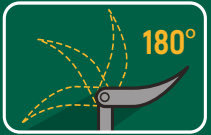

Head rotates 180°

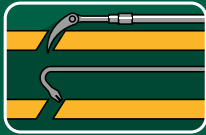

Flex head

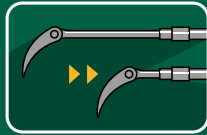

Head profile
grips and holds
securely



Black oxide
finish

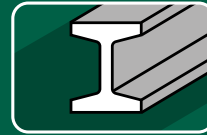

Manufactured
from steel



Magnetic Pick-Up Tool

- Extended shaft for better access
- Features sewn in, powerful magnets which stay on any metal surface easily
- Sleek handle design for maximum power, user comfort, and greater access
- High-impact, contoured handle presents an ergonomic and strong grip
- Oil and solvent resistant handle provides a longer tool life
- Handle designed with "through hole" for easy storage





 Nature of this product is subject to wear and tear upon usage. Not covered under Lifetime Warranty.

Article Code	Overall Length Min (mm)	Overall Length Max (mm)	
ST11924ST	165.0	545.0	6

Flexible Magnetic Pick-Up Tool

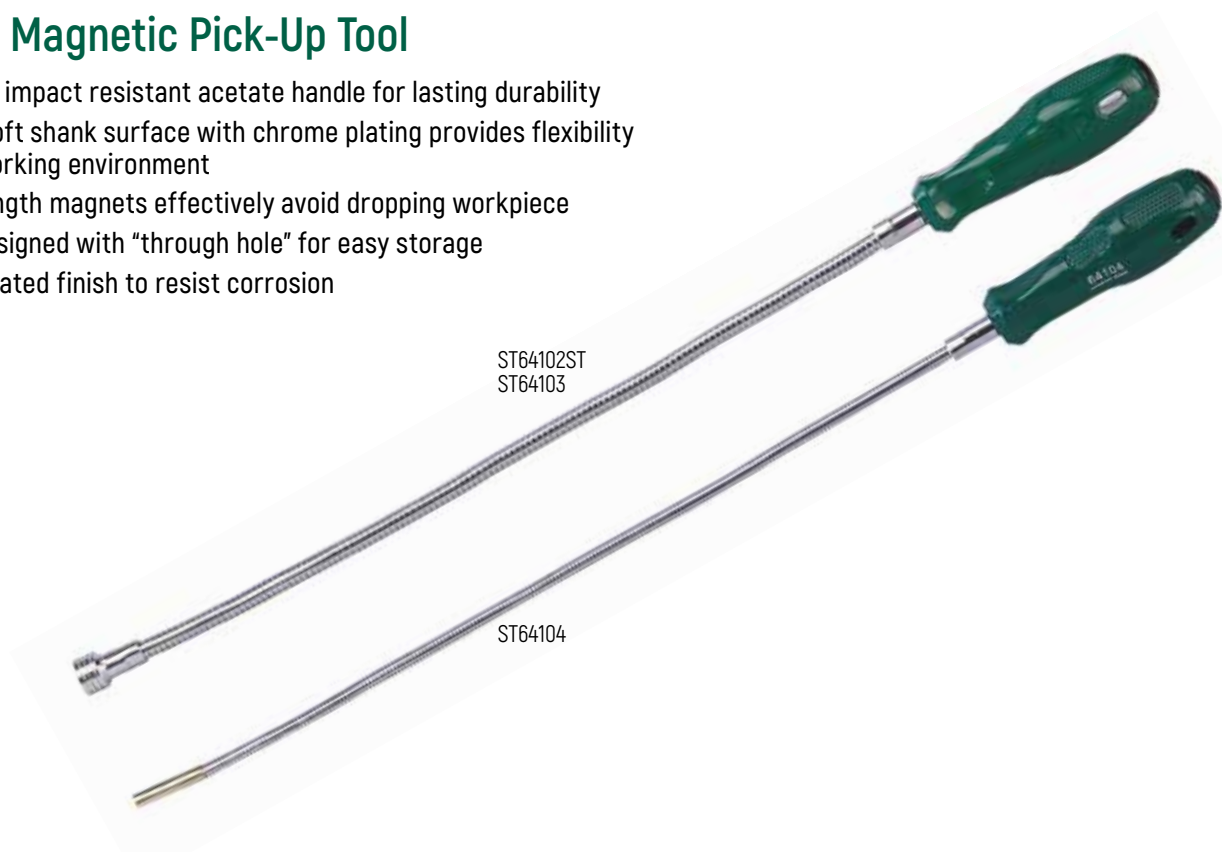
- 100% solid impact resistant acetate handle for lasting durability
- Durable soft shank surface with chrome plating provides flexibility for any working environment
- High-strength magnets effectively avoid dropping workpiece
- Handle designed with "through hole" for easy storage
- Chrome plated finish to resist corrosion



 Nature of this product is subject to wear and tear upon usage. Not covered under Lifetime Warranty.

Article Code	Size (mm)	Holding Capacity (kg)	Overall Length (mm)	
ST64104	6.0	0.5	502.0	6
ST64101	6.0	1.0	502.0	8
ST64102ST	8.0	2.0	510.0	6
ST64103	8.0	3.0	510.0	6

C-Clamp

- Iron frame with steel screw and swivel, sliding pin handle
- Powder coated metal for long lasting durability



 Nature of this product is subject to wear and tear upon usage. Not covered under Lifetime Warranty.

Article Code	Size	Max Crimping Depth (mm)	Max Crimping Thickness (mm)	Overall Height (mm)	Overall Length (mm)	Overall Width (mm)	
ST90433ST	3"	48.0	75.0	92.0	174.0	179.0	4
ST90434ST	4"	54.0	100.0	107.0	216.0	19.0	4
ST90435ST	6"	70.0	150.0	129.0	282.0	21.0	2
ST90436ST	8"	83.0	200.0	147.0	343.0	222.0	1

Mechanics Bench Vise

- Square steel structure provides high strength clamping force for safety use
- Replaceable serrated main jaws provide tight grip
- Large anvil work surface for shaping
- Machined base plate for smooth swivel with lug holes for secure positioning
- Manufactured from heavy duty cast iron for strength and durability



 Nature of this product is subject to wear and tear upon usage. Not covered under Lifetime Warranty.

Article Code	Size	Maxi Crimping Width (mm)	Crimping Force	Jaw Width (mm)	
ST70841SC	4"	108.0	1700 kg	102.0	1
ST70842SC	5"	133.0	2100 kg	127.0	1
ST70843SC	6"	152.0	3000 kg	152.0	1
ST70845SC	8"	203.0	4000 kg	203.0	1



Article Code Index

Article Code	Page No.	Article Code	Page No.	Article Code	Page No.	Article Code	Page No.	Article Code	Page No.	Article Code	Page No.
SC09928	26	SC21501	58	SC34213	104	SC48531	134	SC59472	243	SC90751	258
SC09930-1	29	SC21502	58	SC34303T	109	SC48603	135	SC59473	243	SC90753	258
SC09931-1	30	SC21503	58	SC34304T	109	SC48604	135	SC59474	243	SC90771	258
SC09946-1	27	SC22101	70	SC34305T	109	SC48605	135	SC59475	243	SC90774	258
SC09947-1	28	SC22102	70	SC34306T	109	SC48607	135	SC59476	243	SC90775	258
SC11201	53	SC22103	70	SC34307T	109	SC48609	135	SC80104	247	SC90776	258
SC11202	53	SC22104	70	SC34308T	109	SC48610	135	SC80105	247	SC90782	258
SC11203	53	SC22105	70	SC34309T	109	SC48611	135	SC80106A	247	SC90783	258
SC11204	53	SC22106	70	SC34310T	109	SC48612	135	SC80107A	247	SC90784	258
SC11205	53	SC22107	70	SC34311T	109	SC48613	135	SC80108A	247	SC90785	258
SC11206	53	SC22108	70	SC34312T	109	SC48614	135	SC80110A	247	ST01111	297
SC11207	53	SC22109	70	SC34314T	109	SC48615	135	SC80112A	247	ST01113C	297
SC11208	53	SC22110	70	SC34315T	109	SC48616	135	SC80114A	247	ST01119	298
SC11209	53	SC22111	70	SC34316T	109	SC48617	135	SC80116A	247	ST01133SC	298
SC12111	61	SC22201	70	SC34317T	109	SC48618	135	SC80304	248	ST03141ST	236
SC12201	63	SC22202	70	SC34320T	109	SC48619	135	SC80305	248	ST03142	236
SC12202	63	SC22203	70	SC34403T	111	SC48620	135	SC80306	248	ST03621	12
SC12203	63	SC22204	70	SC34404T	111	SC48621	135	SC80307	248	ST03901ME	191
SC12204	63	SC22205	70	SC34405T	111	SC48622	135	SC80308	248	ST04110SC	36
SC12205	63	SC22206	70	SC34406T	111	SC49201	136	SC80310	248	ST06001SJ	35
SC12206	63	SC22207	70	SC34407T	111	SC49203	136	SC80312	248	ST06002	35
SC12207	63	SC22301	70	SC34408T	111	SC49204	136	SC80314	248	ST06004	35
SC12208	63	SC22302	70	SC34409T	111	SC49205	136	SC80316	248	ST06008SJ	36
SC12209	63	SC22303	70	SC34410T	111	SC49208	136	SC81104	249	ST06011	36
SC12801	101	SC22401	70	SC34411T	111	SC49210	136	SC81105	249	ST08001SJ	122
SC12802	101	SC22402	70	SC34412T	111	SC59211	241	SC81106A	249	ST08002SJ	123
SC12803	101	SC22403	70	SC34414T	111	SC59213	241	SC81107A	249	ST08004SJ	131
SC12804	101	SC22501	70	SC34415T	111	SC59215	241	SC81108	249	ST08006SJ	127
SC12807	101	SC22502	70	SC34417T	111	SC59216	241	SC81110A	249	ST08007ASJ	147
SC12808	101	SC22503	70	SC34420T	111	SC59217	241	SC81111	249	ST08007SJ	131
SC12809	101	SC22504	70	SC34630	114	SC59218	241	SC81112A	249	ST08008SJ	153
SC12810	101	SC22601	70	SC34631	114	SC59221	241	SC81113A	249	ST08010	129
SC12811	101	SC22602	70	SC34634	114	SC59222	241	SC81114A	249	ST08012	131
SC12812	101	SC22603	70	SC34635	114	SC59223	241	SC81116A	249	ST08013	128
SC12814	101	SC22604	70	SC34636	114	SC59224	241	SC81304	250	ST08014SJ	128
SC12815	101	SC25101	89	SC34637	114	SC59231	242	SC81305	250	ST08015SJ	158
SC12816	101	SC25102	89	SC34638	114	SC59232	242	SC81306	250	ST08016	158
SC12817	101	SC25103	89	SC34640	114	SC59233	242	SC81307	250	ST08017	127
SC12820	101	SC25104	89	SC47305	167	SC59234	242	SC81308A	250	ST08018-02	123
SC12821	101	SC25106	89	SC47308	167	SC59235	242	SC81310	250	ST08019-02	129
SC12822	101	SC25107	89	SC47309	167	SC59236	242	SC81312	250	ST08020	149
SC12823	101	SC25108	89	SC47310	167	SC59237	242	SC81314	250	ST08023	132
SC12826	101	SC25109	89	SC47312	167	SC59238	242	SC81316	250	ST08028	23
SC12827	101	SC25201	89	SC47313	167	SC59251	242	SC84321	254	ST08032	155
SC13214	78	SC25202	89	SC47314	167	SC59253	242	SC84322	254	ST08033	163
SC21101	58	SC25203	89	SC47317	167	SC59254	242	SC84324	254	ST08034E	23
SC21102	58	SC25204	89	SC47319	167	SC59255	242	SC84329	254	ST08041	129
SC21103	58	SC25205	89	SC47321	167	SC59256	242	SC84501	255	ST08042	133
SC21107	58	SC25206	89	SC47322	167	SC59257	242	SC84502	255	ST08043U	155
SC21201	58	SC25207	89	SC47324	167	SC59258	242	SC84503	255	ST08044	160
SC21202	58	SC25208	89	SC47325	167	SC59261	241	SC84504	255	ST08044B	160
SC21203	58	SC25209	89	SC48512	134	SC59262	241	SC84505	255	ST08044U	155
SC21204	58	SC25801	89	SC48522	134	SC59263	241	SC84506	255	ST09000	141
SC21205	58	SC25802	89	SC48523	134	SC59415	243	SC84507	255	ST09001SJ	49
SC21206	58	SC25803	89	SC48524	134	SC59416	243	SC84508	255	ST09002SJ	49
SC21301	58	SC25804	89	SC48525	134	SC59417	243	SC84509	255	ST09003SJ	59
SC21302	58	SC25805	89	SC48526	134	SC59421	243	SC84510	255	ST09004SJ	60
SC21303	58	SC25806	89	SC48527	134	SC59422	243	SC84511	255	ST09005SJ	72
SC21401	58	SC25807	89	SC48528	134	SC59423	243	SC84512	255	ST09006SJ	75
SC21402	58	SC34204	104	SC48529	134	SC59424	243	SC84513	255	ST09007SJ	74
SC21403	58	SC34210	104	SC48530	134	SC59471	243	SC84514	255	ST09008SJ	105

Article Code	Page No.	Article Code	Page No.	Article Code	Page No.	Article Code	Page No.	Article Code	Page No.	Article Code	Page No.
ST09009SJ	105	ST09088SJ	75	ST09401SJ	292	ST11109SC	52	ST12311SC	61	ST12912SC	68
ST09010SJ	37	ST09090SJ	73	ST09402SJ	292	ST11110SC	52	ST12312SC	61	ST12913SC	68
ST09011SJ	50	ST09092ME-12	73	ST09405SJ	293	ST11301SC	52	ST12313SC	61	ST12914SC	68
ST09012SJ	138	ST09093	123	ST09406SJ	293	ST11302SC	52	ST12314SC	61	ST12915SC	64
ST09013SJ	50	ST09098SJ	49	ST09407SJ	293	ST11303SC	52	ST12315SC	61	ST12916SC	64
ST09014A	41	ST09099	38	ST09502SJ	38	ST11304SC	52	ST12316SC	61	ST12917SC	68
ST09014SJ	40	ST09101ASJ	247	ST09505SJ	39	ST11305SC	52	ST12317SC	61	ST12919SC	64
ST09015SJ	90	ST09101CHBSJ	252	ST09506SJ	37	ST11306SC	52	ST12318SC	61	ST12920SC	64
ST09017SJ	124	ST09102SJ	247	ST09508	287	ST11307SC	52	ST12401SC	63	ST12922SC	69
ST09018SJ	119	ST09103ASJ	248	ST09509	288	ST11308SC	52	ST12402SC	63	ST12930SC	68
ST09019SJ	124	ST09104SJ	248	ST09510L	41	ST11309SC	52	ST12403SC	63	ST12960SC	65
ST09020SJ	119	ST09105ASJ	249	ST09510SJ	43	ST11310SC	52	ST12404SC	63	ST12970SC	66
ST09021SJ	124	ST09106SJ	249	ST09516SJ	39	ST11311SC	52	ST12405SC	63	ST12971ST	65
ST09022SJ	121	ST09107ASJ	250	ST09519SJ	40	ST11312SC	52	ST12406SC	63	ST12972ST	66
ST09023SJ	155	ST09107CHBSJ	252	ST09520	71	ST11313SC	52	ST12407SC	63	ST12974	67
ST09024SJ	147	ST09108SJ	250	ST09521-02	48	ST11314SC	52	ST12408SC	63	ST12983SC	83
ST09025SJ	157	ST09120SJ	254	ST09521L	48	ST11401SC	53	ST12409SC	63	ST12985SC	87
ST09026SJ	122	ST09121SJ	251	ST09522	48	ST11402SC	53	ST12410SC	63	ST13101SC	76
ST09027SJ	123	ST09122SJ	251	ST09523	59	ST11403SC	53	ST12411SC	63	ST13102SC	76
ST09029SJ	129	ST09123SJ	251	ST09524	59	ST11404SC	53	ST12412SC	63	ST13103SC	76
ST09030	119	ST09124SJ	245	ST09525SJ	71	ST11405SC	53	ST12413SC	63	ST13104SC	76
ST09031SJ	137	ST09131SJ	97	ST09526	72	ST11406SC	53	ST12414SC	63	ST13105SC	76
ST09032	137	ST09132SJ	97	ST09528	21	ST11407SC	53	ST12415SC	63	ST13106SC	76
ST09033SJ	135	ST09134SJ	97	ST09531SJ	287	ST11408SC	53	ST12601BU	62	ST13107SC	76
ST09033U	137	ST09137	100	ST09535SJ	288	ST11409SC	53	ST12602BU	62	ST13108SC	76
ST09034	152	ST09138	100	ST09602SJ	232	ST11410SC	53	ST12603BU	62	ST13109SC	76
ST09037SJ	133	ST09148SJ	90	ST09603SJ	232	ST11901SC	54	ST12604BU	62	ST13110SC	76
ST09038SJ	152	ST09152SJ	287	ST09701	254	ST11903SC	57	ST12605BU	62	ST13111SC	76
ST09040-02	153	ST09161SJ	257	ST09702	255	ST11904SC	57	ST12606BU	62	ST13112SC	76
ST09043SJ	166	ST09162SJ	257	ST09703SJ	293	ST11905ST	54	ST12607BU	62	ST13113SC	76
ST09044	39	ST09163SJ	257	ST09704ASJ	302	ST11906ST	54	ST12608BU	62	ST13114SC	76
ST09050SJ	152	ST09164SJ	257	ST09704SJ	302	ST11909SC	55	ST12609BU	62	ST13115SC	76
ST09051SJ	51	ST09203SJ	71	ST09709SJ	302	ST11910SC	55	ST12610BU	62	ST13201SC	78
ST09052SJ	51	ST09204SJ	72	ST09715	255	ST11911SC	56	ST12611BU	62	ST13202SC	78
ST09053SJ	51	ST09251SJ	184	ST09901SJ	19	ST11912SC	56	ST12612BU	62	ST13203SC	78
ST09054	38	ST09261SJ	173	ST09902SJ	19	ST11913SC	56	ST12613BU	62	ST13204SC	78
ST09057-02	88	ST09262U	35	ST09903SJ	20	ST11914SC	57	ST12614BU	62	ST13205SC	78
ST09060-6SJ	72	ST09302U	229	ST09904-02	21	ST11922SC	57	ST12615BU	62	ST13206SC	78
ST09060SJ	73	ST09303	229	ST09905	21	ST11924ST	315	ST12616BU	62	ST13207SC	78
ST09062-02	122	ST09303ESJ	221	ST09906	22	ST11970SC	54	ST12701SC	64	ST13208SC	78
ST09063	122	ST09304ESJ	221	ST09907	22	ST11974	55	ST12702SC	64	ST13209SC	78
ST09064SJ	121	ST09305SJ	221	ST09908	22	ST12101SC	61	ST12703SC	64	ST13210SC	78
ST09066-02	149	ST09306SJ	221	ST09909-02	23	ST12102SC	61	ST12704SC	64	ST13211SC	78
ST09068SJ	124	ST09309SJ	225	ST09910	24	ST12103SC	61	ST12705SC	64	ST13212SC	78
ST09069SJ	125	ST09311SJ	236	ST09911SJ	24	ST12104SC	61	ST12706SC	64	ST13213SC	78
ST09070SJ	119	ST09312SJ	236	ST09912SJ	24	ST12105SC	61	ST12707SC	64	ST13301SC	76
ST09071SJ	128	ST09313SJ	237	ST09913SJ	25	ST12106SC	61	ST12708SC	64	ST13302SC	76
ST09072SJ	131	ST09314SJ	237	ST09914SJ	25	ST12107SC	61	ST12709SC	64	ST13303SC	76
ST09073SJ	128	ST09315SJ	238	ST09915SJ	20	ST12108SC	61	ST12710SC	64	ST13304SC	76
ST09074SJ	125	ST09316SJ	237	ST09927	17	ST12109SC	61	ST12711SC	64	ST13305SC	76
ST09075	147	ST09317SJ	237	ST09928	19	ST12110SC	61	ST12712SC	64	ST13306SC	76
ST09077SJ	37	ST09324SJ	235	ST09932A	25	ST12301SC	61	ST12901SC	65	ST13307SC	76
ST09078SJ	147	ST09326SJ	235	ST09934	20	ST12302SC	61	ST12903SC	69	ST13308SC	76
ST09079SJ	149	ST09332SJ	238	ST11101SC	52	ST12303SC	61	ST12904SC	69	ST13309SC	76
ST09080SJ	160	ST09333SJ	238	ST11102SC	52	ST12304SC	61	ST12905SC	69	ST13310SC	76
ST09082SJ	163	ST09341SJ	232	ST11103SC	52	ST12305SC	61	ST12906SC	69	ST13311SC	76
ST09083SJ	160	ST09342SJ	233	ST11104SC	52	ST12306SC	61	ST12907SC	69	ST13312SC	76
ST09084SJ	168	ST09343SJ	233	ST11105SC	52	ST12307SC	61	ST12908SC	69	ST13313SC	76
ST09085SJ	60	ST09347	232	ST11106SC	52	ST12308SC	61	ST12909SC	67	ST13314SC	76
ST09086SJ	71	ST09348	233	ST11107SC	52	ST12309SC	61	ST12910SC	67	ST13315SC	76
ST09087SJ	74	ST09350	233	ST11108SC	52	ST12310SC	61	ST12911SC	66	ST13316SC	76

Article Code Index

Article Code	Page No.	Article Code	Page No.	Article Code	Page No.	Article Code	Page No.	Article Code	Page No.	Article Code	Page No.
ST13317SC	76	ST13704SC	81	ST16310SC	91	ST16604SC	92	ST24407BU	87	ST34202SC	104
ST13318SC	76	ST13705SC	81	ST16311SC	91	ST16605SC	92	ST24408IEC	80	ST34203SC	104
ST13319SC	76	ST13706SC	81	ST16312SC	91	ST16606SC	92	ST24410IEC	80	ST34205SC	104
ST13320SC	76	ST13707SC	81	ST16313SC	91	ST16607SC	92	ST24801SC	88	ST34206SC	104
ST13321SC	76	ST13708SC	81	ST16314SC	91	ST16608SC	92	ST24802SC	88	ST34207SC	104
ST13324	76	ST13810	79	ST16315SC	91	ST16609SC	92	ST24803SC	88	ST34208SC	104
ST13401SC	78	ST13812	79	ST16316SC	91	ST16610SC	92	ST24804SC	88	ST34209SC	104
ST13402SC	78	ST13813	79	ST16317SC	91	ST16611SC	92	ST24805SC	88	ST34211SC	104
ST13403SC	78	ST13814	79	ST16318SC	91	ST16612SC	92	ST24806SC	88	ST34212SC	104
ST13404SC	78	ST13816	79	ST16319SC	91	ST16613SC	92	ST24807SC	88	ST34214SC	104
ST13405SC	78	ST13817	79	ST16320SC	91	ST16614SC	92	ST25105SC	89	ST34303SC	108
ST13406SC	78	ST13818	79	ST16321SC	91	ST16615SC	92	ST32902	103	ST34304SC	108
ST13407SC	78	ST13819	79	ST16322SC	91	ST16616SC	92	ST33101SC	109	ST34305SC	108
ST13408SC	78	ST13901SC	82	ST16323SC	91	ST16617SC	92	ST33102SC	109	ST34306SC	108
ST13409SC	78	ST13904SC	86	ST16401SC	90	ST16618SC	92	ST33103SC	109	ST34307SC	108
ST13410SC	78	ST13905SC	86	ST16402SC	90	ST16619SC	92	ST33104SC	109	ST34308SC	108
ST13411SC	78	ST13906SC	86	ST16403SC	90	ST16620SC	92	ST33105SC	109	ST34309SC	108
ST13412SC	78	ST13907SC	86	ST16404SC	90	ST16622SC	92	ST33106SC	109	ST34310SC	108
ST13413SC	78	ST13908SC	86	ST16405SC	90	ST16623SC	92	ST33107SC	109	ST34311SC	108
ST13414SC	78	ST13909SC	84	ST16406SC	90	ST16624SC	92	ST33108SC	109	ST34312SC	108
ST13415SC	78	ST13910SC	84	ST16407SC	90	ST16901SC	93	ST33109SC	109	ST34314SC	108
ST13416SC	78	ST13911SC	84	ST16408SC	91	ST16902SC	95	ST33110SC	109	ST34315SC	108
ST13417SC	78	ST13912SC	85	ST16409SC	91	ST16903SC	95	ST33501BU	113	ST34316SC	108
ST13501SC	77	ST13913SC	85	ST16410SC	91	ST16904SC	95	ST33502BU	113	ST34317SC	108
ST13502SC	77	ST13914SC	85	ST16411SC	91	ST16905SC	94	ST33503BU	113	ST34320SC	109
ST13503SC	77	ST13915SC	80	ST16412SC	91	ST16906SC	94	ST33504BU	113	ST34322SC	109
ST13504SC	77	ST13916SC	80	ST16413SC	91	ST16907SC	95	ST33505BU	113	ST34323SC	109
ST13505SC	77	ST13917SC	80	ST16414SC	91	ST16908SC	95	ST33506BU	113	ST34325SC	109
ST13506SC	77	ST13918SC	80	ST16415SC	91	ST16919SC	94	ST33507BU	113	ST34397T	105
ST13507SC	77	ST13919SC	85	ST16416SC	91	ST17001SC	84	ST33508BU	113	ST34398T	105
ST13508SC	77	ST13930SC	86	ST16417SC	91	ST21104SC	58	ST33509BU	113	ST34399T	107
ST13509SC	77	ST13950SC	85	ST16418SC	91	ST21105SC	58	ST33510BU	113	ST34403SC	110
ST13510SC	77	ST13951SC	84	ST16419SC	91	ST21106	58	ST33511BU	113	ST34404SC	110
ST13511SC	77	ST13960SC	81	ST16420SC	91	ST21108BU	58	ST33512BU	113	ST34405SC	110
ST13512SC	77	ST13970SC	82	ST16421SC	91	ST24101SC	88	ST33513BU	113	ST34406SC	110
ST13513SC	77	ST13971ST	82	ST16422SC	91	ST24102SC	88	ST33514BU	113	ST34407SC	110
ST13514SC	77	ST13972ST	82	ST16501SC	93	ST24103SC	88	ST33515BU	113	ST34408SC	110
ST13515SC	77	ST13974	83	ST16502SC	93	ST24104SC	88	ST33801BU	115	ST34409SC	110
ST13601SC	77	ST13975	48	ST16503SC	93	ST24105SC	88	ST33802BU	115	ST34410SC	110
ST13602SC	77	ST13992BU	83	ST16504SC	93	ST24106SC	88	ST33803BU	115	ST34411SC	110
ST13603SC	77	ST14010SC	79	ST16505SC	93	ST24107SC	88	ST33804BU	116	ST34412SC	110
ST13604SC	77	ST14011SC	79	ST16506SC	93	ST24108SC	88	ST33805BU	116	ST34414SC	110
ST13605SC	77	ST14012SC	79	ST16507SC	93	ST24109SC	88	ST33806BU	116	ST34415SC	110
ST13606SC	77	ST14013SC	79	ST16508SC	93	ST24201SC	87	ST33807BU	116	ST34417SC	110
ST13607SC	77	ST14014SC	79	ST16509SC	93	ST24202SC	87	ST33808BU	116	ST34419SC	110
ST13608SC	77	ST14016SC	79	ST16510SC	93	ST24203SC	87	ST33809BU	116	ST34420SC	110
ST13609SC	77	ST14017SC	79	ST16511SC	93	ST24204SC	87	ST33810BU	116	ST34422SC	110
ST13610SC	77	ST14018SC	79	ST16512SC	93	ST24205SC	87	ST33811BU	116	ST34423SC	110
ST13611SC	77	ST14019SC	79	ST16513SC	93	ST24206SC	87	ST33812BU	116	ST34425SC	110
ST13612SC	77	ST14021SC	79	ST16514SC	93	ST24207SC	87	ST33813BU	116	ST34505SC	112
ST13613SC	77	ST14022SC	79	ST16515SC	93	ST24208SC	87	ST33814BU	116	ST34506SC	112
ST13614SC	77	ST14024SC	79	ST16516SC	93	ST24209SC	87	ST33815BU	116	ST34507SC	112
ST13615SC	77	ST16301SC	91	ST16517SC	93	ST24401BU	87	ST33816BU	116	ST34508SC	113
ST13616SC	77	ST16302SC	91	ST16518SC	93	ST24402BU	87	ST33817BU	116	ST34509SC	113
ST13617SC	77	ST16303SC	91	ST16519SC	93	ST24403BU	87	ST33818BU	116	ST34510SC	113
ST13618SC	77	ST16304SC	91	ST16520SC	93	ST24404BU	87	ST33819BU	116	ST34511SC	113
ST13619SC	77	ST16305SC	91	ST16521SC	93	ST24404IEC	80	ST33820BU	116	ST34512SC	113
ST13620SC	77	ST16306SC	91	ST16522SC	93	ST24405BU	87	ST33821BU	116	ST34513SC	113
ST13701SC	81	ST16307SC	91	ST16523SC	93	ST24405IEC	80	ST33822BU	116	ST34514SC	113
ST13702SC	81	ST16308SC	91	ST16602SC	92	ST24406BU	87	ST33911SC	108	ST34515SC	113
ST13703SC	81	ST16309SC	91	ST16603SC	92	ST24406IEC	80	ST34201BU	104	ST34516SC	113

Article Code	Page No.	Article Code	Page No.	Article Code	Page No.	Article Code	Page No.	Article Code	Page No.	Article Code	Page No.
ST34517SC	113	ST34831SC	115	ST40204SC	126	ST41207SC	130	ST42214SC	132	ST43207ST	156
ST34518SC	113	ST34832SC	115	ST40205SC	126	ST41208SC	130	ST42215SC	132	ST43208ST	156
ST34519SC	113	ST34833SC	115	ST40206SC	126	ST41209SC	130	ST42216SC	132	ST43209ST	156
ST34520SC	113	ST34834SC	115	ST40207SC	126	ST41210SC	130	ST42217SC	132	ST43210ST	156
ST34521SC	113	ST34835SC	115	ST40208SC	126	ST41211SC	130	ST42218SC	132	ST43211ST	156
ST34522SC	113	ST34836SC	115	ST40209SC	126	ST41212SC	130	ST42219SC	132	ST43212ST	156
ST34523SC	113	ST34837SC	115	ST40210SC	126	ST41213SC	130	ST42220SC	132	ST43213ST	156
ST34524SC	113	ST34838SC	115	ST40211SC	126	ST41214SC	130	ST42221SC	132	ST43214ST	156
ST34525SC	113	ST34839SC	115	ST40212SC	126	ST41215SC	130	ST42222SC	132	ST43215ST	156
ST34526SC	113	ST34840SC	115	ST40213SC	126	ST41216SC	130	ST42223SC	132	ST43216ST	156
ST34527SC	113	ST34841SC	115	ST40214SC	126	ST41217SC	130	ST42224SC	132	ST43217ST	156
ST34528SC	113	ST34842SC	115	ST40215SC	126	ST41218SC	130	ST42225SC	132	ST43218ST	156
ST34529SC	113	ST34843SC	115	ST40216SC	126	ST41219SC	130	ST42301	133	ST43219ST	156
ST34530	113	ST34844SC	115	ST40217SC	126	ST41220SC	130	ST42302	133	ST43220ST	156
ST34605SC	114	ST34845SC	115	ST40218SC	126	ST41221SC	130	ST42303	133	ST43221ST	156
ST34606SC	114	ST34846SC	115	ST40219SC	126	ST41222SC	130	ST42304	133	ST43222ST	156
ST34607SC	114	ST34847SC	115	ST40220SC	126	ST41223SC	130	ST42305	133	ST43501	150
ST34608SC	114	ST34848SC	115	ST40221SC	126	ST41225ST	130	ST42306	133	ST43502	150
ST34609SC	114	ST34849SC	115	ST40222SC	126	ST41226	130	ST42307	133	ST43503	150
ST34610SC	114	ST34850SC	115	ST40223SC	126	ST41227ST	130	ST42309	133	ST43504	150
ST34611SC	114	ST34851SC	115	ST40223SC	126	ST41301SC	130	ST42310	133	ST43505	150
ST34612SC	114	ST34852SC	115	ST40233SC	126	ST41302SC	130	ST42312	133	ST43506	150
ST34613SC	114	ST34853SC	115	ST40235SC	126	ST41303SC	130	ST42315	133	ST43508	150
ST34614SC	114	ST34924SC	116	ST40236SC	126	ST41304SC	130	ST42406SC	140	ST43511	150
ST34615SC	114	ST34925SC	116	ST40237SC	126	ST41305SC	130	ST42407SC	140	ST43512	150
ST34616SC	114	ST34926SC	116	ST40241SC	126	ST41306SC	139	ST42408SC	140	ST43601	150
ST34617SC	114	ST34928SC	116	ST40242SC	126	ST41306SC	139	ST42409SC	140	ST43602	150
ST34618SC	114	ST34929SC	116	ST40243SC	126	ST41307SC	139	ST42410SC	140	ST43603	150
ST34619SC	114	ST34930SC	116	ST40244SC	126	ST41308SC	139	ST42411SC	140	ST43604	150
ST34620SC	114	ST34931SC	116	ST40245SC	126	ST41309SC	139	ST42412SC	140	ST43605	150
ST34621SC	114	ST34934SC	116	ST40246SC	126	ST41310SC	139	ST42413SC	140	ST43606	150
ST34622SC	114	ST34937SC	116	ST40248SC	126	ST41311SC	139	ST42414SC	140	ST43607	150
ST34623SC	114	ST34938SC	116	ST40249SC	126	ST41312SC	139	ST42415SC	140	ST43608	150
ST34624SC	114	ST34938SC	116	ST40250SC	126	ST41313SC	139	ST42416SC	140	ST43609	150
ST34625SC	114	ST34940SC	116	ST40251SC	126	ST41314SC	139	ST42417SC	140	ST43610	150
ST34626SC	114	ST40101SC	126	ST40252SC	126	ST41315SC	139	ST42418SC	140	ST43611	150
ST34628SC	114	ST40102SC	126	ST40281SC	127	ST41316SC	139	ST42419SC	140	ST43612	150
ST34628SC	114	ST40103SC	126	ST40282SC	127	ST41317SC	139	ST42419SC	140	ST43612	150
ST34629SC	114	ST40104SC	126	ST40283SC	127	ST41318SC	139	ST42421SC	140	ST43613	150
ST34701SC	104	ST40105SC	126	ST40284SC	127	ST41319SC	139	ST42422SC	140	ST43614	150
ST34702SC	104	ST40106SC	126	ST40285SC	127	ST41321SC	139	ST42424SC	140	ST43615	150
ST34703SC	108	ST40107SC	126	ST40286SC	127	ST41322SC	139	ST43101ST	156	ST43616	150
ST34704SC	108	ST40108SC	126	ST40287SC	127	ST41324SC	139	ST43102ST	156	ST43617	150
ST34705SC	108	ST40109SC	126	ST40288SC	127	ST42101SC	132	ST43103ST	157	ST43618	150
ST34706SC	108	ST40110SC	126	ST40289SC	127	ST42102SC	132	ST43104ST	157	ST43619	150
ST34708SC	112	ST40111SC	126	ST40290SC	127	ST42104SC	132	ST43105ST	157	ST45201SC	138
ST34712SC	112	ST40112SC	126	ST40291SC	127	ST42105SC	132	ST43106ST	157	ST45202SC	138
ST34714SC	103	ST40113SC	126	ST40292SC	127	ST42106SC	132	ST43107ST	157	ST45203SC	138
ST34715SC	103	ST40114SC	126	ST41101SC	130	ST42107SC	132	ST43108ST	157	ST45204SC	138
ST34716SC	107	ST40115SC	126	ST41102SC	130	ST42201SC	132	ST43109ST	157	ST46135U	157
ST34717SC	107	ST40116SC	126	ST41103SC	130	ST42202SC	132	ST43110ST	157	ST46200ST	158
ST34718SC	111	ST40117SC	126	ST41104SC	130	ST42203SC	132	ST43111ST	157	ST46201ST	158
ST34719SC	107	ST40118SC	126	ST41105SC	130	ST42204SC	132	ST43112ST	157	ST46202ST	158
ST34720SC	112	ST40119SC	126	ST41106SC	130	ST42205SC	132	ST43113ST	157	ST46203ST	158
ST34721SC	111	ST40120SC	126	ST41107SC	130	ST42206SC	132	ST43114ST	157	ST46204ST	158
ST34824SC	115	ST40121SC	126	ST41108SC	130	ST42207SC	132	ST43115ST	157	ST46205ST	158
ST34825SC	115	ST40122SC	126	ST41201SC	130	ST42208SC	132	ST43201ST	156	ST46206ST	158
ST34826SC	115	ST40123SC	126	ST41202SC	130	ST42209SC	132	ST43202ST	156	ST46301	159
ST34827SC	115	ST40124SC	126	ST41203SC	130	ST42210SC	132	ST43203ST	156	ST46302	159
ST34828SC	115	ST40201SC	126	ST41204SC	130	ST42211SC	132	ST43204ST	156	ST46303ST	159
ST34829SC	115	ST40202SC	126	ST41205SC	130	ST42212SC	132	ST43205ST	156	ST46304ST	159
ST34830SC	115	ST40203SC	126	ST41206SC	130	ST42213SC	132	ST43206ST	156	ST46305ST	159

Article Code Index

Article Code	Page No.	Article Code	Page No.	Article Code	Page No.	Article Code	Page No.	Article Code	Page No.	Article Code	Page No.
ST46306ST	159	ST46673BU	162	ST47503ST	134	ST61104SC	224	ST62310SC	223	ST70141ST	178
ST46307ST	159	ST46674BU	162	ST47504ST	134	ST61105SC	224	ST62311SC	223	ST70201AST	175
ST46308ST	159	ST46675BU	162	ST47505ST	134	ST61106SC	224	ST62312SC	223	ST70202AST	175
ST46309	159	ST46676BU	162	ST47506ST	134	ST61107SC	224	ST62313SC	223	ST70203AST	175
ST46310ST	159	ST46677BU	163	ST47507ST	134	ST61108SC	224	ST62314SC	223	ST70232ST	175
ST46311	159	ST46678BU	163	ST47509ST	134	ST61211SC	231	ST62315SC	223	ST70233ST	175
ST46312ST	159	ST46679BU	163	ST47530	152	ST61212SC	231	ST62316SC	223	ST70301AST	176
ST46322	159	ST46680BU	163	ST47701SC	136	ST61213SC	231	ST62317SC	223	ST70302AST	176
ST46323	159	ST46681BU	163	ST47702SC	136	ST61214SC	231	ST62501ST	310	ST70303AST	176
ST46324	159	ST46682BU	163	ST47703SC	136	ST61221SC	230	ST62502ST	310	ST70331ST	176
ST46325	159	ST46683BU	163	ST47704SC	136	ST61222SC	230	ST62503ST	311	ST70332ST	176
ST46326	159	ST46801ST	166	ST47705SC	136	ST61223SC	230	ST62601ST	311	ST70333ST	176
ST46327	159	ST46802ST	166	ST47706SC	136	ST61224SC	230	ST62709	284	ST70411ST	179
ST46328	159	ST46803ST	166	ST47707SC	136	ST61311SC	231	ST62712	284	ST70412ST	179
ST46401ST	165	ST46804ST	166	ST47710SC	136	ST61312SC	231	ST62713	284	ST70413ST	179
ST46402ST	165	ST46805ST	166	ST47712SC	136	ST61313SC	231	ST63402SC	226	ST70414ST	179
ST46403ST	165	ST46806ST	166	ST48101ST	301	ST61314SC	231	ST63403SC	226	ST70511ST	179
ST46404ST	165	ST46807ST	166	ST48200SC	137	ST61315SC	231	ST63404SC	226	ST70512ST	179
ST46405ST	165	ST46808ST	166	ST48201SC	137	ST61321SC	230	ST63405SC	226	ST70601ME	179
ST46406ST	165	ST46809ST	166	ST48202SC	137	ST61322SC	230	ST63407SC	226	ST70602ME	179
ST46407ST	165	ST46810ST	166	ST48203SC	137	ST61323SC	230	ST63408SC	226	ST70611AST	176
ST46408ST	165	ST46811ST	166	ST48204SC	137	ST61324SC	230	ST63409SC	226	ST70612AST	177
ST46409ST	165	ST46812ST	167	ST48301SC	137	ST61325SC	230	ST63410SC	226	ST70613AST	177
ST46410ST	165	ST46813ST	167	ST48302SC	137	ST61503SC	224	ST63411SC	226	ST70614AST	177
ST46412	165	ST46814ST	167	ST48303SC	137	ST61504SC	224	ST63412SC	226	ST70615AST	178
ST46413ST	165	ST46815ST	167	ST48505	134	ST61505SC	224	ST63413SC	226	ST70616AST	178
ST46414	165	ST46816ST	167	ST48506	134	ST61506SC	224	ST63414SC	226	ST70621ME	181
ST46415	165	ST46817ST	167	ST48507	134	ST61507SC	224	ST63415SC	226	ST70622ME	181
ST46421	165	ST46902	167	ST48509	134	ST61508SC	224	ST63416SC	226	ST70642ST	181
ST46422	165	ST46904	167	ST48515	134	ST61603SC	228	ST63417SC	226	ST70711ST	180
ST46471BU	165	ST46905	167	ST48516	134	ST61605SC	228	ST63502SC	227	ST70721ST	180
ST46473BU	165	ST46906	167	ST48517	134	ST61606SC	228	ST63503SC	227	ST70812ST	145
ST46476BU	165	ST46909	167	ST48519	134	ST61607SC	228	ST63504SC	227	ST70813ST	145
ST46477BU	165	ST46911	167	ST48520	134	ST61608SC	228	ST63505SC	227	ST70814ST	145
ST46478BU	165	ST46912	167	ST48521	134	ST61703SC	229	ST63507SC	227	ST70815ST	145
ST46479BU	165	ST47101SC	141	ST49202BU	136	ST61705SC	229	ST63508SC	227	ST70816ST	145
ST46480BU	165	ST47102SC	141	ST50402	191	ST61706SC	229	ST63509SC	227	ST70817ST	145
ST46481BU	165	ST47103SC	141	ST53301	218	ST61707SC	229	ST63510SC	227	ST70818ST	145
ST46482BU	165	ST47104SC	141	ST53302	218	ST61708SC	229	ST63511SC	227	ST70819ST	145
ST46601ST	162	ST47122	144	ST53303	218	ST62202SC	222	ST63512SC	227	ST70841SC	316
ST46602ST	162	ST47123	144	ST53304	218	ST62203SC	222	ST63513SC	227	ST70842SC	316
ST46603ST	162	ST47124	144	ST53305	218	ST62204SC	222	ST63514SC	227	ST70843SC	316
ST46604ST	162	ST47125	144	ST53306	218	ST62205SC	222	ST63515SC	227	ST70845SC	316
ST46605ST	162	ST47130	143	ST53307	218	ST62207SC	222	ST63516SC	227	ST71002	182
ST46606ST	162	ST47201SC	143	ST53308	218	ST62208SC	222	ST63517SC	227	ST71101ST	182
ST46607ST	162	ST47202SC	143	ST53309	218	ST62209SC	222	ST64101	315	ST71102ST	182
ST46608ST	162	ST47203SC	143	ST53310	218	ST62210SC	222	ST64102ST	315	ST71103ST	182
ST46609ST	162	ST47204SC	143	ST53311	218	ST62211SC	222	ST64103	315	ST71202ST	182
ST46610ST	162	ST47205SC	143	ST53312	218	ST62212SC	222	ST64104	315	ST71203ST	182
ST46611ST	162	ST47206SC	143	ST53313	218	ST62213SC	222	ST66202SC	228	ST71301ST	183
ST46612ST	162	ST47207SC	143	ST53314	218	ST62214SC	222	ST66203SC	228	ST71302ST	183
ST46613	162	ST47208SC	143	ST53401	218	ST62215SC	222	ST66204SC	228	ST71401SC	183
ST46614	162	ST47221SC	144	ST53402	218	ST62216SC	222	ST66205SC	228	ST71501SC	183
ST46615	162	ST47222SC	144	ST59271ST	240	ST62217SC	222	ST66206SC	228	ST71601SC	184
ST46616	162	ST47223SC	144	ST59272ST	240	ST62302SC	223	ST70001U	173	ST71701SC	184
ST46617	162	ST47224SC	144	ST59273ST	240	ST62303SC	223	ST70002U	173	ST72001ST	185
ST46654ST	169	ST47225SC	144	ST59274	240	ST62304SC	223	ST70003U	180	ST72002ST	185
ST46655ST	169	ST47226SC	144	ST61002SC	225	ST62305SC	223	ST70101AST	174	ST72004ST	185
ST46656ST	169	ST47403	168	ST61101SC	224	ST62307SC	223	ST70102AST	174	ST72005ST	185
ST46671BU	162	ST47501ST	134	ST61102SC	224	ST62308SC	223	ST70131ST	174	ST72011ST	186
ST46672BU	162	ST47502ST	134	ST61103SC	224	ST62309SC	223	ST70132ST	174	ST72012ST	186

Article Code	Page No.	Article Code	Page No.	Article Code	Page No.	Article Code	Page No.	Article Code	Page No.	Article Code	Page No.
ST72013ST	186	ST90628SC	303	ST91513	280	ST92531SC	263	ST93438	210	ST95441	310
ST72014ST	186	ST90633SC	303	ST91521SC	280	ST92532SC	263	ST93441SC	208	ST95442	10
ST72021ST	186	ST90634SC	303	ST91522SC	280	ST92533SC	263	ST93442SC	208	ST96211SC	171
ST72022ST	186	ST90636SC	303	ST91531SC	281	ST92534SC	263	ST93443SC	209	ST96212SC	171
ST72023ST	186	ST90638SC	303	ST91532SC	281	ST92535SC	263	ST93446SC	209	ST96311SC	171
ST72024ST	186	ST90640	303	ST91533SC	281	ST92568	313	ST93470SC	213	ST96312SC	171
ST72031ST	186	ST90642	303	ST91601ME	281	ST92569	313	ST93473	212	ST96313SC	171
ST72032ST	186	ST90651SC	304	ST91602ME	281	ST92901SC	264	ST93474	212	ST96411SC	171
ST72033ST	186	ST90652SC	305	ST91603ME	281	ST92902SC	264	ST93481	207	ST96412SC	171
ST72034ST	186	ST90658ST	304	ST91604ME	281	ST92903SC	264	ST93482	207	ST97201	308
ST72041ST	187	ST90662SC	304	ST91605ME	281	ST92904SC	264	ST93483	207	ST97203	308
ST72042ST	187	ST90665	305	ST91606ME	281	ST92912ME	264	ST93485	209	ST97204A	308
ST72043ST	187	ST90762SC	258	ST91611ME	282	ST92913ME	264	ST93486	208	ST97211	307
ST72044ST	187	ST90772SC	258	ST91612ME	282	ST93101ST	193	ST93501SC	202	ST97212	307
ST72302B-02	175	ST90786SC	258	ST91613ME	282	ST93102ST	193	ST93502ST	203	ST97213	307
ST72401	174	ST91101	188	ST91614ME	282	ST93103ST	193	ST93503ST	203	ST97221SC	309
ST72501ST	181	ST91102ST	188	ST91615ME	282	ST93104ST	193	ST93504ST	203	ST97222SC	309
ST72502ST	181	ST91104ST	188	ST91616	282	ST93105	199	ST93505ST	203	ST97301ST	213
ST72503ST	181	ST91105ST	189	ST91621ME	282	ST93106	198	ST93506ST	203	ST97302ST	213
ST72511	215	ST91106ST	189	ST92101SC	259	ST93107	199	ST93507ST	203	ST97303ST	214
ST83105SC	251	ST91107ST	189	ST92102SC	259	ST93108	201	ST93508ST	203	ST97304ST	215
ST83106SC	251	ST91108ST	192	ST92103SC	259	ST93109	200	ST93509ST	203	ST97305ST	213
ST83107SC	251	ST91201ST	192	ST92104SC	259	ST93110	200	ST93601	203	ST97311ST	214
ST83108SC	251	ST91202ST	192	ST92105SC	259	ST93121	198	ST93603	204	ST97312ST	214
ST83110SC	251	ST91212ST	192	ST92106SC	259	ST93122	197	ST93621ME	218	ST97401ST	294
ST83112SC	251	ST91213ST	192	ST92107SC	305	ST93125	196	ST93622ME	218	ST97403ST	294
ST83113SC	251	ST91311E	275	ST92203SC	306	ST93126	197	ST93623ME	218	ST97404ST	294
ST83114SC	251	ST91312E	275	ST92205SC	306	ST93127	194	ST93624ME	218	ST97405	294
ST83116SC	251	ST91312ME	275	ST92207SC	306	ST93128	194	ST93625ME	218	ST97406	294
ST83305SC	252	ST91314ME	275	ST92209SC	306	ST93129	196	ST95101SC	10	ST97407	294
ST83306SC	252	ST91315E	275	ST92301	260	ST93201	201	ST95102SC	11	ST97422ST	296
ST83307SC	252	ST91316E	275	ST92302SC	260	ST93202	201	ST95103ASC	11	ST97426ST	296
ST83308SC	252	ST91316ME	275	ST92303SC	260	ST93203	201	ST95104ASC	10	ST97427SC	294
ST83310SC	252	ST91317E	275	ST92304SC	260	ST93204	201	ST95107SC	17	ST97428SC	294
ST83312SC	252	ST91317ME	275	ST92305	260	ST93204	201	ST95108SC	14	ST97431ME	295
ST83313SC	252	ST91318E	275	ST92306SC	261	ST93302ST	202	ST95109SC	17	ST97441ST	295
ST83314SC	252	ST91322E	275	ST92307SC	261	ST93303ST	202	ST95111SC	16	ST97451SC	296
ST83316SC	252	ST91323E	275	ST92308	261	ST93304ST	202	ST95115SC	11	ST97452SC	296
ST84318SC	254	ST91333ME	277	ST92312SC	260	ST93305ST	202	ST95118SC	15	ST97501SC	301
ST84320SC	254	ST91335ME	277	ST92313SC	260	ST93306ST	202	ST95119SC	15	ST97502SC	301
ST84323SC	254	ST91336ME	277	ST92314SC	260	ST93404	215	ST95121	16	ST97521ST	187
ST84325SC	254	ST91361ME	277	ST92315	260	ST93404ME	217	ST95125	15	ST97701SC	307
ST84328	254	ST91362ME	277	ST92322SC	261	ST93405ME	217	ST95126	16	ST97702SC	307
ST90433ST	316	ST91363ME	277	ST92323SC	261	ST93405SC	216	ST95161SC	11	ST97801ASC	291
ST90434ST	316	ST91401	282	ST92324SC	261	ST93411	216	ST95162SC	11	ST97802ASC	291
ST90435ST	316	ST91402	282	ST92401SC	262	ST93413	216	ST95164SC	12	ST97803ASC	291
ST90436ST	316	ST91403	282	ST92402SC	262	ST93416	217	ST95181	12	ST97804ASC	291
ST90501SC	309	ST91404	282	ST92403SC	262	ST93417	217	ST95182SC	12	ST97805ASC	291
ST90502	309	ST91410ME	278	ST92404SC	262	ST93418	217	ST95184SC	13	ST97807ASC	291
ST90504	309	ST91411ME	278	ST92405SC	262	ST93422A	206	ST95188	13	ST97808ASC	291
ST90606	268	ST91412ME	278	ST92406SC	262	ST93424A	204	ST95198SC	13	ST97809ASC	291
ST90607	268	ST91413ME	278	ST92501	262	ST93425A	205	ST95201ST	313	ST97810ASC	291
ST90608	270	ST91421ME	278	ST92502SC	262	ST93426SC	205	ST95207S	32	ST97813A	292
ST90609	272	ST91430ME	278	ST92503SC	262	ST93428SC	206	ST95208S	31	ST97817SC	291
ST90610	272	ST91431ME	278	ST92504SC	262	ST93429	206	ST95211	14		
ST90613	271	ST91432ME	278	ST92505	262	ST93432A	211	ST95213SC	14		
ST90614	271	ST91501SC	280	ST92521SC	263	ST93433A	210	ST95400	51		
ST90620	270	ST91502SC	280	ST92522SC	263	ST93434A	211	ST95401	51		
ST90623SC	303	ST91503SC	280	ST92523SC	263	ST93435A	212	ST95410	121		
ST90624SC	303	ST91511SC	280	ST92524SC	263	ST93436	210	ST95411	121		
ST90626SC	303	ST91512SC	280	ST92525SC	263	ST93437	211	ST95440	310		



Lifetime Warranty

All SATA Products (unless otherwise stated) are fully warranted against manufacturing default including faulty materials and workmanship, subjected to being used for its intended purpose and allowing for fair wear and tear.

Defective tools will be repaired and/or replaced at SATA's discretion free of charge. They should be held by buyers or returned for inspection to the factory upon request.

This Lifetime Warranty does not extend to products that have been improperly used, altered, abused or repaired by others. Rustiness after usage, electroplate desquamation, surface scraped or plastic handle damage are not within warranty range. Damage in the packaging is also out of warranty range.

Warranty Information



The obvious dent or electroplate desquamation indicates that a pipe wrench or hammer (or other form of "cheater") has been abused on this ratchet. Please use a larger size of ratchet to increase the leverage of any wrench.



The obvious slippage on socket end or crack on socket wall indicates that this impact tools has been used on this socket. When you are working with impact tools, please choose impact sockets with black coat.



The breach of handle, blade chip-off and bent shanks are the results of using screwdriver as a pry bar, punch or chisel.

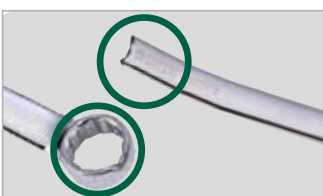

Distort or breach on the wrench is also result of using the wrench as a pry bar. Please use the right pry bar for prying.

Torx® is a registered trademark of Acument Intellectual Properties, LLC.

Authorized Distributor

Apex Tool Group B.V.
Phileas Foggstraat 16
7821 AK Emmen
The Netherlands
T. +31(0)591667504
www.satatools.eu

Disclaimer

Specifications subject to change without notice.
SATA is a registered trademark of Apex Brands, Inc. | © 2023
HT1100 101SATA / 01.23 BO 5.0